

Beyond Your Expectations

REFRIGERATOR MANUFACTURER
Turbo air



**THE AAA
VALUE**
Maintenance Cost (A)
Operating Cost (A)
Acquisition Cost (A)
= Low Ownership Cost



Outstanding Reliability / Superior Functionality / Excellent Convenience

www.turboairinc.com

**No Innovation
No Future**

REFRIGERATOR MANUFACTURER
Turbo air



My 57-Year Journey with Refrigeration

At 13 years old, I began my part-time job to pay for school, which started my 57-year career in refrigeration. I found that I had an aptitude for the work, and more importantly, I enjoyed it. It didn't take long until it wasn't just about raising money for school. I kept at it, and I dropped out of college my freshman year to start my own refrigeration business. I invested my last \$30, taking a risk that paid off. It grew rapidly, and when I was 25 I founded South Korea's first plant to mass-produce commercial refrigerators.

In 1985, I emigrated from South Korea to Los Angeles, where I continued to follow my passions. I opened my business selling and repairing refrigerators. I also constructed restaurants and grocery stores, finding the refrigeration systems and layouts that best fit their needs. Through my combined experiences, I became an expert on the environments which refrigerators operated in and all my competitor's products. As I built my expertise, I noticed that there was little-to-no technological advancement. The products had remained the same over several decades, across all major manufacturers. I knew there was a better way.

I founded Turbo Air with innovation and consumer convenience at the forefront. Turbo Air was the first company to apply digital control in commercial refrigerators, in 1997, and now it's the industry standard. I pioneered the use of automatic fans, temperature control and external monitoring, and indoor illumination for under-counter and salad/sandwich units. I work towards improving Turbo Air products every day, and I continue to lead the charge with my patented Self-Cleaning Condenser. This revolutionary device marks the end of the 100-year-old problem, rooted in ill-maintained condensers.

My innovation goes beyond technology, as I am the trailblazer of innovation in customer service. One of the many precedents I have set in this industry is direct delivery to dealers, with 13 warehouse locations nationwide. Multiple locations ensure damage free delivery within 1-2 days. Also, I utilize in-house technicians, who complete 95% of service calls within 3 business days. I am also the first to implement the MSP (minimum sales price) program in the refrigeration industry to alleviate excessive competition among dealers. I am always looking to improve, not only the products but your experience with customer service.

It has been 57 wonderful years, and my journey still continues.

Sincerely,

Brian S. Kim

Brian S. Kim
Chief Engineer & CEO

Global Turbo Air

Manufacturing Divisions



World Headquarters (Long Beach, CA)
Commercial Refrigerator



Commercial Refrigerator
Manufacturing Subsidiary (Dallas, TX)



Commercial Refrigeration System
Manufacturing Subsidiary (Long Beach, CA)



Commercial Refrigerator
Manufacturing Subsidiary (Gwangju, Korea)



Commercial Refrigerator
Manufacturing Subsidiary (Qingdao, China)



Commercial Refrigerator
Manufacturing Subsidiary (Ho Chi Minh, Vietnam)



Commercial Refrigerator
Manufacturing Subsidiary (Ho Chi Minh, Vietnam)



Commercial Refrigerator (Cancún, Mexico)
Sales in Mexico



Commercial Baking & Cooking Equipment
(Long Beach, CA)



Commercial Freezer Manufacturing Subsidiary
(Gwangju, Korea)



CALIFORNIA HEADQUARTERS



TEXAS, USA PLANT



GWANGJU, KOREA PLANT



QINGDAO, CHINA PLANT



HO CHI MINH, VIETNAM PLANT



HO CHI MINH, VIETNAM PLANT

Patented **Self-Cleaning Condenser**



Exclusive to Turbo Air, our patented rotating condenser cleaning brush does not require basic preventative maintenance for warranty claims

Dust accrue rapidly in areas where refrigeration is installed and used. Dust is drawn through the fan and accumulated, preventing the condenser from properly releasing heat. This causes the compressor to increase its pressure on refrigerants, increasing the possibility of the compressor breaking down.

The 'Self-Cleaning Condenser' cleans the condenser with a rotating brush that moves up and down 2-3 times a day, preventing any dust build-up and maintaining the highest efficiency while saving additional energy.

Condenser Coil Maintenance Pays Off

(‘Energy Manager Today’)

Richard Fennelly, the Director of Product Development for CoilPod LLC says that there is not a lot of research on how much money can be saved, but all signs point to a significant amount. It is also a distasteful job that often gets pushed aside.

The condensers coils that are at the heart of cooling equipment need to be cooled. This cooling is provided by a fan that draws in air. That air carries minute pieces of debris along for the ride. The vents get clogged and the fan must work harder to do its job. This causes three problems: The fans use more electricity and therefore are costlier to run, they require more service calls and, ultimately, many fail. Often, these failures result in ruined inventory.

Addressing this problem leads relatively easy gains. The greatest are “grab and go” type refrigerator units common in delicatessens and convenience stores since they are in high trafficked public areas. Fennelly, whose company offers

a new approach to condenser coil cleaning, pointed to statistics compiled by the Food Service Technology Center (FSTC) and presented at the Restaurant Facility Managers Association and Commercial Food Equipment Service Association conferences last year.

The estimates, which presumably are based on refrigeration devices the FSTC found in the field, are predicated on an electric rate of \$0.11 per kWh.

A six-year-old double door merchandiser costs \$1,325 per year when dirty.

Operating expense is cut to \$625 – a reduction of 47 percent – when the coils are cleaned.

A large double door fridge (age unspecified) cost \$950 per year to run.

That cost is shaved by 46 percent, to \$433, when the coils are cleaned.

The other examples are in the same range.

Fennelly said that food service technicians often say that the most common cause of service calls are problems that arise from clogged condenser coil housings. Typically, the approach to cleaning debris is to use a brush, vacuum or wetvac. These steps are a good start but, ultimately ineffective because the problems often are deeper in the apparatus and can't be dislodged in this way.

by Carl Weinschenk / October 18, 2016

(<https://www.energymanagertoday.com/condenser-coil-maintenance-pays-off>)

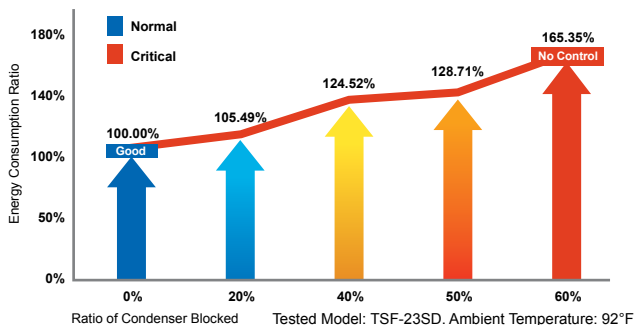

Energy Consumption Ratio

Environmentally Friendly

Natural refrigerant is used in all Turbo Air refrigerators



The most common refrigerants that have been used in the industry are HFCs (hydrofluorocarbons R-134a, R-404A), replacements for CFCs (chlorofluorocarbons) which are harmful substances proven to deplete the ozone layer. HFCs are not directly ozone-depleting but these strong greenhouse gases have been shown to have a negative impact on the environment, contributing to global warming up to 4,000 times more than CO₂. These GWP refrigerants are listed among substances regulated by the Kyoto Protocol of 1992, and HFC substances such as R-134a and R-404A will be banned by new U.S. government regulations starting January 1, 2019.

The industry must embrace the new climate-friendly natural refrigerant HC (hydrocarbons).



All temperature information provided is obtained through NSF standard testing environment.
Each of our products certifications may differ under certain specifications and various options.



Turbo Air is committed to the environment with innovative and eco-friendly technology!

By utilizing our innovative, eco-friendly technology, Turbo Air has now replaced all previous refrigerants with climate-friendly hydrocarbons R-600a (Isobutane) and R-290 (Propane). In our efforts to protect our environment, we have decreased energy consumption by 25%.

What is Hydrocarbon?

HC (hydrocarbon) is a sustainable alternative to HFC. Hydrocarbons (R-600a, R-290) are natural refrigerants that have no ODP (ozone depleting potential) and very low GWP (global warming potential). Moreover, HC based equipment have been shown to be more energy efficient compared to HFC based equipment, which translates to lower operating costs. The EPA approved R-290 (Propane) and R-600a (Isobutane) as acceptable refrigerants for use in commercial refrigeration, stand-alone equipment refrigerators, and freezers.

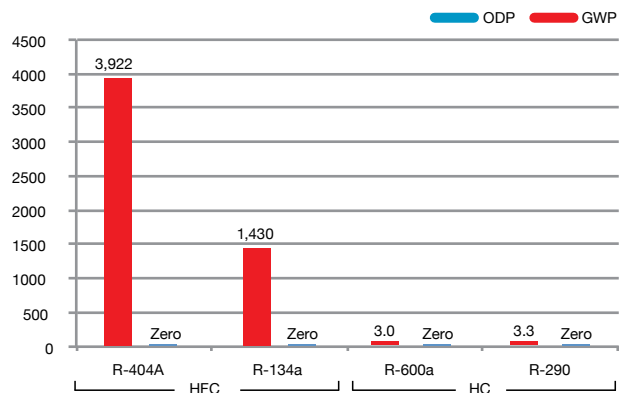

U.S. Environmental Protection Agency [2010] EPA-430-F-10-043

We generate power by reducing consumption

Turbo Air has 140+ Energy Star® certificated models*

* Accurate at the time of print.

We built our products to rely on their naturally emitted energy, thus reducing electrical energy consumption. Turbo Air strives for sustainability without sacrificing performance and durability.



Self-Cleaning Condenser (Patented)

Dust accrue rapidly in areas where refrigeration is installed and used. Dust is drawn through the fan and accumulated, preventing the condenser from properly releasing heat. This causes the compressor to increase its pressure on refrigerants, increasing the possibility of the compressor breaking down.

The 'Self-Cleaning Condenser' cleans the condenser with a rotating brush that moves up and down 2-3 times a day, preventing any dust build-up and maintaining the highest efficiency while saving additional energy.

2 & 3 Glass Door Freezers powered by 115V

Turbo Air's 2 & 3 Glass Door Freezers are powered by 115V. Not only is the 115V simple and easy to plug in and operate, it also saves customers over \$1,000 in electrical line installation for 220V powered glass door freezers. This feature is proof of our dedication to energy efficiency and the environment.

Efficient Refrigeration System

Refrigerators achieve their cooling effect by discharging heat through the condenser. In order to achieve high efficiency, it is important to increase the effectiveness of the condensers, especially in hot & humid places, such as the kitchen. Turbo Air uses condensers that are 10%~20% larger than the industry standard.

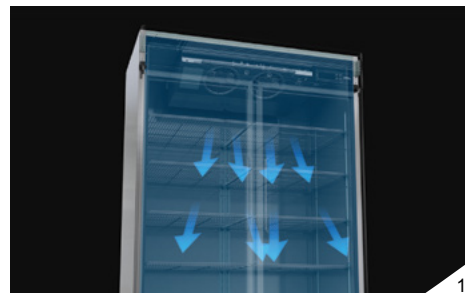

1/ Turbo Cooling & Freeze
2/ Condensate Water Cooling System

No Electrical Cabinet Heater Needed

Electrical heaters in glass door freezers operate 24/7 in order to prevent water flow to the cabinet surface. This causes unnecessary energy consumption, and sometimes is the reason behind overheating. Instead of frame heaters, Turbo Air glass door freezers harness the heat produced by the compressor during the condensing stage, eliminating any unnecessary energy consumption as well as providing the most efficient freezer performance available.

Condensate Water Cooling System

Unique to Turbo Air Reach-In products, our anti-corrosion pipes are coated on the surface with a special treatment, allowing the excess condensate waters to cool down the pipe's hottest area during the refrigerant compression process. This not only saves energy, but also eliminates the need for additional drains, which prevents slippery floors from becoming a safety issue.

Turbo Cooling & Freeze Feature for Faster Chilling

The Turbo Cooling and Freeze function, located on the control panel, allows the compressor to run continuously for up to two hours. When this function is activated, the temperature inside the cabinet quickly decreases and cools drinks, food, and other products much more quickly. An ideal time to use the Turbo Cooling and Freeze function is when the unit is stocked with new products.

Preventing Heat Transfer

Triple pane vacuum glass and plastic frame material are used to prevent heat transfer and to increase energy efficiency. Specially gilded aluminum exterior materials have both beauty and durable practicality.

Turbo Air is a technology-driven company

We are constantly striving to make products that are durable and functional while also beautiful with excellent convenience. Our innovations keep continuing and the light never goes off in our R&D department.



Door Pressure Release Device (Patented, only at Turbo Air)

When you try to reopen the refrigerator/freezer door immediately, the internal pressure difference prevents it from opening for at least 1~2 minutes. Waiting for 1~2 minutes during a restaurant's busy time is certainly not a short duration from the user's perspective. Turbo Air's patented pressure release device allows easy and quick reopening.

Self-Cleaning Condenser (Patented)

Dust accrue rapidly in areas where refrigeration is installed and used. Dust is drawn through the fan and accumulated, preventing the condenser from properly releasing heat. This causes the compressor to increase its pressure on refrigerants, increasing the possibility of the compressor breaking down. The 'Self-Cleaning Condenser' cleans the condenser with a rotating brush that moves up and down 2-3 times a day, preventing any dust build-up and maintaining the highest efficiency while saving additional energy.

Early Warning System (Only at Turbo Air)

Malfunctions are generally recognized when an increase in temperature is detected, 2 to 3 hours after the refrigerator has stopped running. This causes the user to become aware of malfunction issues the next morning when the contents have already spoiled. To eliminate this risk, Turbo Air units have a warning system in place that diagnose and monitor itself for risk factors, which gives early warning signals to preserve contents and prevent future problems.

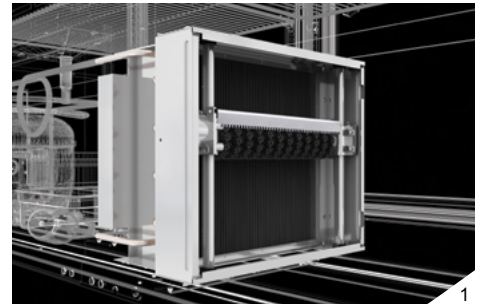

1/ Self-Cleaning Condenser
2/ Digital Temperature Control System

Self-Diagnosis System

When a refrigerator breaks, it will immediately run a self-diagnosis to figure out what the problem is, saving both service time and unnecessary expenses that could have occurred by misdiagnosis. It also allows for broken parts to be replaced easily.

Digital Temperature Control System

Digital technology provides precise and consistent temperatures throughout the cabinet. This allows food products to remain fresh over an extended period of time.

On-Line Connected, Real Time Monitoring System

When the unit is connected to the internet, it will retain all of its temperature history. Wherever you are, you will be able to check the unit's status via mobile devices or the computer. You will also be able to control temperatures as well as turn the unit on and off remotely. If the unit becomes defective, it will automatically contact the designated person.

60mm Thick High Density Wall

To prevent heat transfer from where it's produced the most (compressor room), Turbo Air designed a specially reinforced 60mm thick, high-density wall to provide greater insulation and to increase overall efficiency.

Immediate, Reliable Delivery Nationwide

Branch / Distribution Locations

CALIFORNIA Headquarters

4184 E. Conant St., Long Beach, CA 90808
Tel. 310-900-1000 Toll Free. 800-627-0032
Warranty Service. 800-381-7770



HAWAII	179 Sand Island Access Rd. #B Honolulu, HI 96819	Tel. 808-843-1988 Fax. 808-843-1991
OAKLAND	1617 Whipple Rd. Suite A Hayward, CA 94544	Tel. 510-382-0983 Fax. 510-475-5692
SEATTLE	2515 142nd Ave. E. Sumner, WA 98390	Tel. 253-518-0380 Fax. 253-826-3162
DENVER	3650 Fraser St. Unit C Aurora, CO 80011	Tel. 720-459-5887 Fax. 720-459-5886
HOUSTON	4300 N. Sam Houston Pkwy. W. #410 Houston, TX 77086	Tel. 281-880-4946 Fax. 281-730-8081
DALLAS	1800 S. Great Southwest Pkwy. Grand Prairie, TX 75051	Tel. 214-678-9380 Fax. 214-678-9386

Fastest Warranty Service In the Industry

We understand the frustration and disappointment customers feel when their refrigerators are not promptly fixed. Our in-house technicians fulfill 95% of all service calls within three days and deliver two-day service parts throughout the United States.



Part Distribution

13 warehouses
15 major part distributors
2 Day delivery throughout the United States



In-house Technicians available in 17 locations

2,000 Technician Network

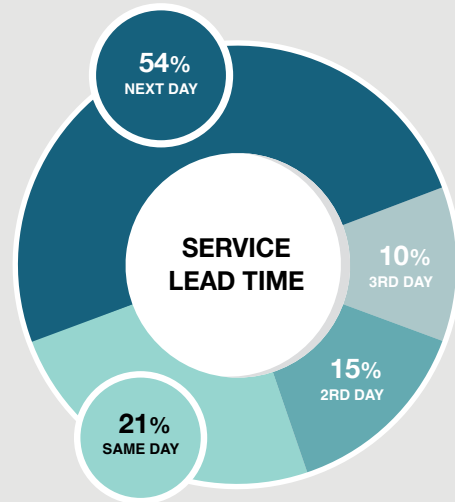

95% of service calls fulfilled within 3 business days.



CHICAGO



CINCINNATI



ATLANTA



NEW JERSEY



PITTSBURGH



MIAMI

CHICAGO

1213 Lakeview Drive
Romeoville, IL 60446

Tel. 630-439-0015
Fax. 630-439-0017

CINCINNATI

12080 Best Place
Sharonville, OH 45241

Tel. 513-772-5272
Fax. 513-772-5276

ATLANTA

5345 Buford Highway
Norcross, GA 30071

Tel. 770-449-1112
Fax. 770-248-9525

NEW JERSEY

10 Basin Dr. Suite 110
Kearny, NJ 07032

Tel. 973-274-1993
Fax. 973-274-1990

PITTSBURGH

201 Locust St. Suite B2
Youngwood, PA 15697

Tel. 412-777-9653
Fax. 724-635-0023

MIAMI

2701 SW 145th Ave. Suite 220
Miramar, FL 33027













Tel. 305-885-5722
Fax. 305-885-5723



SUPPORT

Immediate Availability

Rep. / Distributor & Warehouse Information

TYPE	COMPANY	TERRITORY	LOCATION	PHONE	FAX
HQ. B/W		South West	4184 E. Conant St., Long Beach, CA 90808	310-900-1000	310-900-1077
B/W		South West	1617 Whipple Rd. Suite A, Hayward, CA 94544	510-382-0983	510-475-5692
B/W		North West	2515 142nd Ave E., Sumner, WA 98390	253-518-0380	253-826-3162
B/W		Mountain West	3650 Fraser St. Unit C, Aurora, CO 80011	720-459-5887	720-459-5886
DIST.	R.E.W.	HI	179 Sand Island Access Rd. Unit B, Honolulu, HI 96819	808-843-1988	808-843-1991
REP.	EMC Hospitality	WA, OR, AK	1130 Broadway, Suite 209, Tacoma, WA 98402	503-998-4599	
B/W		South Central	1800 S. Great Southwest Pkwy., Grand Prairie, TX 75051	214-678-9380	214-678-9386
B/W		South Central	4300 N. Sam Houston Pkwy., Houston, TX 77086	281-880-4946	281-730-8081
B/W		Mid West	101 E. Crossroads Pkwy. Suite B, Bolingbrook, IL 60440	630-439-0014	630-439-0017
B/W		Mid West	12080 Best Place, Sharonville, OH 45241	513-772-5272	513-772-5276
B/W		South East	5345 Buford Highway, Norcross, GA 30071	770-449-1112	770-248-9525
B/W		South East	2701 SW 145th Ave. Suite 220, Miramar, FL 33027	305-885-5722	305-885-5723
B/W		North East	10 Basin Dr. Suite 110, Kearny, NJ 07032	973-274-1993	973-274-1990
B/W		North East	201 Locust St. Suite B, Youngwood, PA 15697	412-777-9653	724-635-0023
DIST.	Food Service Solutions (FSS)	Canada	6599 Kitimat Rd #2, Mississauga, ON L5N 4J4	800-668-8765	
REP.	DMM Enterprises	Metro NY, N.NJ	1 Quail Hollow Lane, West Nyack, NY 10994	914-450-5192	201-525-1437
REP.	Ability Reps	CT, VT, MA, NH, RI, ME	10 Blackburn Center, Gloucester, MA 01930	978-281-2700	978-281-2987

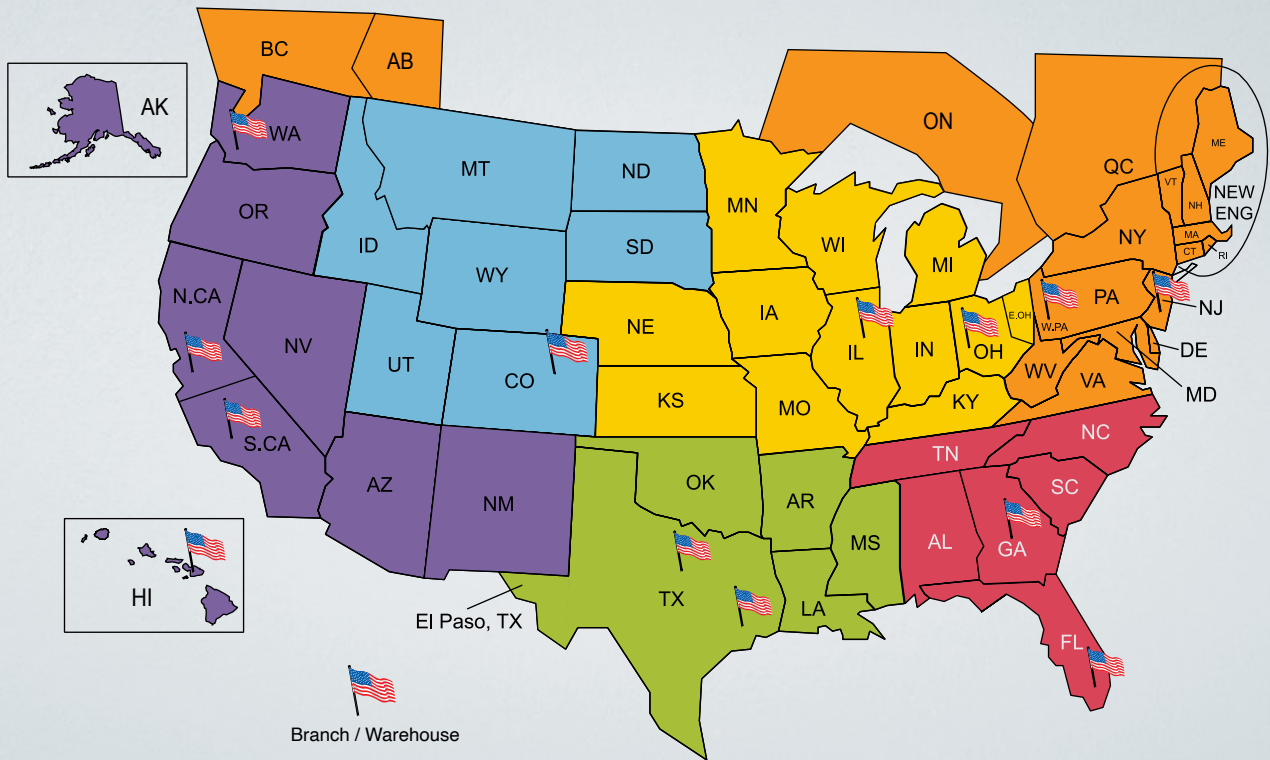

Sales Territory Map

West	Mountain	Central	Midwest	Southeast	East
Keith Kim 310-505-7420	Keith Kim 310-505-7420	June Park 562-577-2099	Chris Bae 630-442-4786	Andrew Kim 562-307-4355	Kevin Kim 562-305-3837
Sobhan Pishkouhi 310-900-1028	Saeme Park 310-900-1011	Martin Nam 214-723-7300	Isabell Lee 630-523-5112	Mark Ok 678-278-1439	Carolina Daza 973-679-9253
Saeme Park (AZ/NM) 310-900-1011			Minah Lee 630-439-0014	Andy Lee 678-278-1437	Fayth Hartkopf 862-279-7405
Michael Hartman (WA/OR/AK) 503-998-4599			Saeme Park (KS) 310-900-1011		Brian Mahoney 201-525-1433
Rudy Kim 310-900-1056					Owen Freeman 978-281-2700

National Sales Team

Mike Andrus	Rick Blinson	D.J. Kourie	Charles Kim	Carlos Fuentes	Bill Smith	Steven Burke
National Account 214-770-3126	National Account 678-814-2201	National Account 330-447-8411	National Account 310-900-1050	National Account 512-501-9192	National Account 314-378-0524	National Account 512-296-1999

Table of Contents

REACH-IN REFRIGERATORS & FREEZERS

PRO Series - Solid Doors / Glass Doors / Pass-Thru / Roll-In / Heated Cabinets	022 - 065
Super Deluxe Series - Solid Doors / Glass Doors	066 - 069
M3 Series - Solid Doors / Dual Temp./ Glass Doors / Heated Cabinets	070 - 079

FOOD PREP TABLES

PRO Series	
Sandwich & Salad Units - Solid Doors / Glass Doors / Drawers	082 - 086
Mega Top Units - Solid Doors / Drawers	087 - 092
Prep Table + Work Stations	093 - 100
Front Breathing Airflow - Solid Doors / Drawers	101 - 107
Super Deluxe Series	
Pizza Prep Tables - Solid Doors / Drawers	108 - 109
Sandwich & Salad Units - Solid Doors / Drawers	110 - 118
Mega Top Units - Solid Doors / Drawers	119 - 125
Prep Tables + Work Stations - Solid Doors / Drawers	126 - 129
Front Breathing Airflow - Solid Doors / Drawers	130 - 137
Front Breathing Airflow / Prep Tables + Work Stations - Solid Doors / Drawers	138 - 149
M3 Series	
Sandwich & Salad Units - Solid Doors	150 - 150
Mega Top Units - Solid Doors	151 - 151
Front Breathing Airflow - Solid Doors	152 - 152
J Series	
Sandwich & Salad Units - Solid Doors	153 - 153
Buffet Display Tables	154 - 154
E-line - Countertop Salad Tables	155 - 158

UNDERCOUNTERS / WORKTOPS / CHEF BASES

Undercounter Refrigerators & Freezers

PRO Series	
Solid Doors / Glass Doors / Drawers	160 - 165
Front Breathing Airflow - Solid Doors / Drawers	166 - 170
Super Deluxe Series	
Solid Doors / Drawers	171 - 175
Front Breathing Airflow - Solid Doors / Drawers	176 - 180
M3 Series - Solid Doors / Low Boy / Shallow Depth	181 - 185
J Series - Solid Doors / Narrow / Extra Deep / Dual Temp.	186 - 193

Worktop Refrigerators & Freezers

PRO Series	
Solid Doors / Glass Doors / Drawers	195 - 199
Front Breathing Airflow - Solid Doors / Drawers	200 - 204
Super Deluxe Series	
Solid Doors / Drawers	205 - 210
Front Breathing Airflow - Solid Doors / Drawers	211 - 215
M3 Series - Shallow Depth	216 - 216
Chef Bases	
PRO Series - Refrigerators / Freezers	217 - 220
Super Deluxe Series - Refrigerators / Freezers / Extended Top	221 - 222

GLASS DOOR MERCHANDISERS

Super Deluxe Series Glass Door Merchandisers	
Swing Door Refrigerators / Freezers	224 - 230
Super Deluxe Jumbo Series Swing Door Ice Merchandiser	231 - 231
Glass Swing Door Merchandisers	232 - 232
Standard Series Glass Door Merchandisers	
Swing Doors Refrigerators / Sliding Door Refrigerators / Swing Door Freezers	233 - 235
Ice Merchandisers	236 - 236
Top Open Island Freezers	237 - 237
Ice Cream Dipping Cabinets	238 - 238

DISPLAY CASES

Open Display Merchandisers	
Horizontal Cases - Glass Panel / Solid Panel	240 - 244
Combination Cases - Curved Front Glass / European Straight Front Glass	245 - 246
Horizontal Cases - European Straight	247 - 250
Drop-In Type Horizontal Cases - European Straight	251 - 255
Sandwich & Cheese Cases	256 - 256
Vertical Cases - Glass Panel / Solid Panel / Extra Deep	257 - 261
Vertical Air Curtains	262 - 265
Island Display Cases	266 - 270
Bakery & Deli Display Cases	
Deli Cases - Direct Cooling Type	271 - 271
Bakery Cases - Refrigerated / Dry Combination / Dry Cases	272 - 277

UNDERBAR EQUIPMENT

Bottle Coolers	280 - 280
Glass / Mug Frosters	281 - 281
Beer Dispensers / Club Top Beer Dispensers	282 - 283
Back Bars / Narrow Back Bars	284 - 287

MILK COOLERS

Milk Coolers	290 - 290
---------------------------	-----------

WARRANTY INFORMATION

Warranty	291 - 291
-----------------------	-----------

REFRIGERATION SYSTEM

Unit Coolers	294 - 301
Condensing Units	302 - 314
Package Units - SMART 7	315 - 318
Product & Service / Warranty Statement	319 - 320

PARTS & ACCESSORIES

Parts & Accessories List	322 - 325
---	-----------



Turbo Air Solves Challenges

Turbo Air is proud to introduce this astonishing, convenient device as a great solution in the refrigeration industry:

Self-Cleaning Condenser

Did you know that dirty condenser coils are the main reason for most service calls?

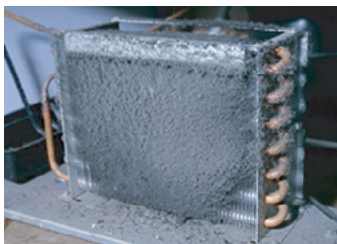

Busy marketplaces and restaurant kitchens with heavy traffic accumulate massive amounts of dust. Dust is drawn through the fan and builds rapidly in the system, increasing energy consumption and the workload of the compressor which shortens its lifespan. Though condenser cleaning is one of

the most important maintenance procedures in refrigeration, whether you do it yourself or hire a technician, manually cleaning the condenser regularly is both costly and time consuming.

Major Issues



ENERGY CONSUMPTION
INCREASE



COMPRESSOR
FAILURE



HEALTH INSPECTION
FAILURE



MANUFACTURER
WARRANTY VOID

Save on operating cost & maintenance cost
= Low ownership cost

With Turbo Air's Self-Cleaning Condenser, operators could potentially save from \$200~\$800 on professional cleaning services per call, and save on repair costs related to compressor replacement.

Self-Cleaning Condenser is a standard feature at no additional cost and applicable on most of our product lines. Turbo Air's customers can enjoy warranty coverage without maintenance requirements.



Self-Cleaning Condenser

HOW DOES IT WORK?

Turbo Air's patented Self-Cleaning Condenser is an innovative feature that uses a fine mesh filter to catch the dust, while the rotating brush moves up and down 2~3 times a day to remove the excess outward and away from the condenser, effectively preventing dust from accumulating in the first place.

This allows your system to maintain the highest efficiency while mitigating premature system failure.



Fine Mesh Filter



Rotating Brush

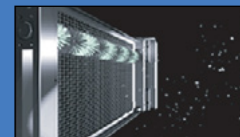

Prevent Dust Build up



Let's Watch Turbo Air's
Self-Cleaning Condenser Video!

www.turboairinc.com



Reach-In Refrigerators & Freezers

PRO Series

Solid / Glass Doors
Pass-Thru Solid / Glass Doors
Roll-In Solid / Glass Doors
Solid / Glass Door Heated Cabinets
Pass-Thru Heated Cabinets
Roll-In Heated Cabinets
Solid / Glass / Roll-In Proofers

Super Deluxe Series

Solid / Glass Doors

M3 Series

Solid / Half Solid Doors
Dual Temp. Solid Doors
Glass Doors
Solid / Glass / Pass-Thru Heated Cabinets

SOLID/HALF SOLID DOOR REFRIGERATORS NATURAL Refrigerant

Self-Cleaning Condenser Equipped Units

■ **Self-Cleaning Condenser (Patented)**

The accumulation of dust in the condenser can cause the failure or breakdown of refrigerators. Refrigerators run normally until they reach a certain level of accumulation. At some point, when they are over the limit, their performance drops quickly resulting in damage to, or disposal of the stored products inside. The Self-Cleaning Condenser device keeps the condenser clean and prevents system failure by automatically brushing daily.

■ **Digital temperature control & monitor system**

- Keeps food products safe by maintaining constant temperatures
- Alarms that sound when doors are not sealed shut; protects against food spoilage that originates from cold air leaks
- Early warning alarm program detects issues before malfunction occurs
- Digital display allows for easy monitoring
- Programs interpret the condition of refrigeration systems by self-diagnosis
- Rapid cool-down function (Turbo Cooling)
- Automatic evaporator fan motor delays

■ **Hydrocarbon refrigerants (R-290)**

With innovative and eco-friendly technology, Turbo Air brings you hydrocarbon refrigerators designed to meet DOE's Energy Conservation Standards in 2017 and to use EPA's SNAP Program approved HC refrigerants. Hydrocarbon refrigerants do not deplete the ozone layer and have very low contribution to global warming (ODP-0, GWP-3).

■ **Cold air distribution system**

Provides uniformly maintained temperature within the food zone.

■ **Hot gas condensate system**

Through Turbo Air's creative innovation, the condensate system surfaces have been specially treated to resist corrosion. This not only increases efficiency without the risk of refrigerant leakage from corrosion, but also prevents the overflow of condensate water.

■ **All stainless steel cabinet construction**

The PRO series model boasts a stainless steel interior and a 22 gauge stainless steel exterior (galvanized steel top, bottom). It guarantees the utmost in cleanliness and long product life. The PRO series model adds a touch of style to the most refined setting.

■ **Sturdy, clean stainless steel shelving**

Shelves are the most important part of cleanliness as they come in direct contact with food. After a while, PVC coated wire shelves may peel, rust and lead to unsanitary conditions. Only the Turbo Air PRO series uniquely provides stainless steel shelving.

■ **LED interior lighting**



■ **Left hinged models available**

(PRO-12R-N-L, PRO-15R-N-L, PRO-12-2R-N-L, PRO-15-2R-N-L)

■ **High-density polyurethane insulation**

The entire cabinet structure and solid doors are foamed-in-place using high density, CFC free polyurethane insulation.

■ **Refrigerator holds 33°F ~ 38°F for the best in food preservation**

■ **Standard features**

- Top mount compressor
- Anti-corrosion coated evaporator
- Easily replaceable one-piece magnetic door gaskets
- Self-contained system
- Solid and sturdy grille design
- Door locks
- 4" dia. swivel casters with locks on the front set
- USB temperature data storage
- Lead time applies

■ **Optional features**

- Legs available for all models

PRO-R MODELS SPECIFICATIONS

ELECTRICAL DATA	PRO-12R-N	PRO-15R-N	PRO-12-2R-N	PRO-15-2R-N
Voltage	115/60/1	115/60/1	115/60/1	115/60/1
Plug Type	Ⓜ NEMA 5-15P	Ⓜ NEMA 5-15P	Ⓜ NEMA 5-15P	Ⓜ NEMA 5-15P
Full Load Amp.	2.5	2.5	2.5	2.5
Compressor HP	1/4+	1/4+	1/4+	1/4+
Cord Length (ft.)	9	9	9	9
Refrigerant	R-290	R-290	R-290	R-290
DIMENSIONAL DATA				
Net Capacity (cu. ft.)	9.6	13.18	9.4	12.67
Ext. Dimension (L x D [†] x H [†]) (in.)	17 ³ / ₄ x 27 ¹ / ₄ x 78	17 ³ / ₄ x 34 ³ / ₈ x 78	17 ³ / ₄ x 27 ¹ / ₄ x 78	17 ³ / ₄ x 34 ³ / ₈ x 78
Int. Dimension (L x D x H) (in.)	13 ³ / ₄ x 20 ¹ / ₄ x 52 ³ / ₄	13 ³ / ₄ x 26 ⁵ / ₈ x 52 ³ / ₄	13 ³ / ₄ x 20 ¹ / ₄ x 52 ³ / ₄	13 ³ / ₄ x 26 ⁵ / ₈ x 52 ³ / ₄
# of Doors	1	1	2	2
# of Racks Accepted	-	-	-	-
# of Shelves (Size (L x D) (in.))	3 (12 ¹ / ₂ x 18 ³ / ₄)	3 (12 ¹ / ₂ x 25 ¹ / ₈)	3 (12 ¹ / ₂ x 18 ³ / ₄)	3 (12 ¹ / ₂ x 25 ¹ / ₈)
Net Weight (lbs.)	178	255	178	255
Gross Weight (lbs.)	262	298	262	298

Design and specifications subject to change without notice. Most updated spec sheets are available at www.turboairinc.com.

Actual shipping weight may differ due to extra packing materials for product protection.

* Depth does not include 4-1/8" for door handles and rear condensate enclosure. † Height does not include 5" for caster height.

■ **WARRANTY: 5 Year Parts and Labor Warranty, 7 Year Compressor Warranty**

SOLID DOOR REFRIGERATORS NATURAL Refrigerant

Self-Cleaning Condenser Equipped Units

Self-Cleaning Condenser
Maintenance-free
during warranty period

■ **Self-Cleaning Condenser (Patented)**

The accumulation of dust in the condenser can cause the failure or breakdown of refrigerators. Refrigerators run normally until they reach a certain level of accumulation. At some point, when they are over the limit, their performance drops quickly resulting in damage to, or disposal of the stored products inside. The Self-Cleaning Condenser device keeps the condenser clean and prevents system failure by automatically brushing daily.

■ **Digital temperature control & monitor system**

- Keeps food products safe by maintaining constant temperatures
- Alarms that sound when doors are not sealed shut; protects against food spoilage that originates from cold air leaks
- Early warning alarm program detects issues before malfunction occurs
- Digital display allows for easy monitoring
- Programs interpret the condition of refrigeration systems by self-diagnosis
- Rapid cool-down function (Turbo Cooling)
- Automatic evaporator fan motor delays

■ **Hydrocarbon refrigerants (R-290)**

With innovative and eco-friendly technology, Turbo Air brings you hydrocarbon refrigerators designed to meet DOE's Energy Conservation Standards in 2017 and to use EPA's SNAP Program approved HC refrigerants. Hydrocarbon refrigerants do not deplete the ozone layer and have very low contribution to global warming (ODP-0, GWP-3).

■ **Cold air distribution system**

Provides uniformly maintained temperature within the food zone.

■ **Hot gas condensate system**

Through Turbo Air's creative innovation, the condensate system surfaces have been specially treated to resist corrosion. This not only increases efficiency without the risk of refrigerant leakage from corrosion, but also prevents the overflow of condensate water.

■ **All stainless steel cabinet construction**

The PRO series model boasts a stainless steel interior and a 22 gauge stainless steel exterior (galvanized steel top, bottom). It guarantees the utmost in cleanliness and long product life. The PRO series model adds a touch of style to the most refined setting.

■ **Sturdy, clean stainless steel shelving**

Shelves are the most important part of cleanliness as they come in direct contact with food. After a while, PVC coated wire shelves may peel, rust and lead to unsanitary conditions. Only the Turbo Air PRO series uniquely provides stainless steel shelving.

■ **LED interior lighting**

■ **Left hinged (PRO-26R-N-L), all left hinged (PRO-77R-N-AL), all right hinged (PRO-77R-N-AR) models available**



PRO-26R-N



PRO-50R-N

■ **High-density polyurethane insulation**

The entire cabinet structure and solid doors are foamed-in-place using high density, CFC free polyurethane insulation.

■ **Thermostatic expansion valves**

■ **Refrigerator holds 33°F ~ 38°F for the best in food preservation**

■ **Standard features**

- Top mount compressor
- USB temperature data storage
- Anti-corrosion coated evaporator
- Easily replaceable one-piece magnetic door gaskets
- Self-contained system
- Solid and sturdy grille design
- Door locks
- 4" dia. swivel casters with locks on the front set

■ **Optional features**

- Legs available for all models
- Tray slides available

PRO-R MODELS SPECIFICATIONS

ELECTRICAL DATA	PRO-26R-N	PRO-50R-N	PRO-77R-N
Voltage	115/60/1	115/60/1	115/60/1
Plug Type	Ⓢ NEMA 5-15P	Ⓢ NEMA 5-15P	Ⓢ NEMA 5-15P
Full Load Amp.	7.0	8.0	9.0
Compressor HP	1/2	1/2	1
Cord Length (ft.)	9	9	9
Refrigerant	R-290	R-290	R-290
DIMENSIONAL DATA			
Net Capacity (cu. ft.)	25.41	47.73	75.06
Ext. Dimension (L x D x H†) (in.)	28 ³ / ₄ x 34 ¹ / ₈ x 78	51 ³ / ₄ x 34 ¹ / ₈ x 78	77 ³ / ₄ x 34 ¹ / ₈ x 78
Int. Dimension (L x D x H) (in.)	23 ⁷ / ₈ x 27 ⁵ / ₈ x 58 ³ / ₄	46 ³ / ₄ x 27 ⁵ / ₈ x 58 ³ / ₄	72 ⁷ / ₈ x 27 ⁵ / ₈ x 58 ³ / ₄
# of Doors	1	2	3
# of Racks Accepted	1	2	3
# of Shelves (Size (L x D) (in.))	3 (23 ¹ / ₂ x 26 ³ / ₈)	6 (22 ³ / ₄ x 26 ³ / ₈ (L/R))	9 (22 ³ / ₄ x 26 ³ / ₈ (L/R), 25 x 26 ³ / ₈ (M))
Net Weight (lbs.)	309	485	609
Gross Weight (lbs.)	352	538	684

Design and specifications subject to change without notice. Most updated spec sheets are available at www.turboairinc.com.

Actual shipping weight may differ due to extra packing materials for product protection.

* Depth does not include 1-1/4" for door handles. † Height does not include 5" for caster height.

■ **WARRANTY: 5 Year Parts and Labor Warranty, 7 Year Compressor Warranty**

HALF SOLID DOOR REFRIGERATORS NATURAL Refrigerant

Self-Cleaning Condenser Equipped Units

■ **Self-Cleaning Condenser (Patented)**

The accumulation of dust in the condenser can cause the failure or breakdown of refrigerators. Refrigerators run normally until they reach a certain level of accumulation. At some point, when they are over the limit, their performance drops quickly resulting in damage to, or disposal of the stored products inside. The Self-Cleaning Condenser device keeps the condenser clean and prevents system failure by automatically brushing daily.

■ **Digital temperature control & monitor system**

- Keeps food products safe by maintaining constant temperatures
- Alarms that sound when doors are not sealed shut; protects against food spoilage that originates from cold air leaks
- Early warning alarm program detects issues before malfunction occurs
- Digital display allows for easy monitoring
- Programs interpret the condition of refrigeration systems by self-diagnosis
- Rapid cool-down function (Turbo Cooling)
- Automatic evaporator fan motor delays

■ **Hydrocarbon refrigerants (R-290)**

With innovative and eco-friendly technology, Turbo Air brings you hydrocarbon refrigerators designed to meet DOE's Energy Conservation Standards in 2017 and to use EPA's SNAP Program approved HC refrigerants. Hydrocarbon refrigerants do not deplete the ozone layer and have very low contribution to global warming (ODP-0, GWP-3).

■ **Cold air distribution system**

Provides uniformly maintained temperature within the food zone.

■ **Hot gas condensate system**

Through Turbo Air's creative innovation, the condensate system surfaces have been specially treated to resist corrosion. This not only increases efficiency without the risk of refrigerant leakage from corrosion, but also prevents the overflow of condensate water.

■ **All stainless steel cabinet construction**

The PRO series model boasts a stainless steel interior and a 22 gauge stainless steel exterior (galvanized steel top, bottom). It guarantees the utmost in cleanliness and long product life. The PRO series model adds a touch of style to the most refined setting.

■ **Sturdy, clean stainless steel shelving**

Shelves are the most important part of cleanliness as they come in direct contact with food. After a while, PVC coated wire shelves may peel, rust and lead to unsanitary conditions. Only the Turbo Air PRO series uniquely provides stainless steel shelving.

■ **LED interior lighting**

■ **Left hinged (PRO-26-2R-N-L), all right hinged (PRO-50-4R-N-AR) models available**

Self-Cleaning Condenser
Maintenance-free
during warranty period



PRO-26-2R-N



PRO-50-4R-N

■ **High-density polyurethane insulation**

The entire cabinet structure and solid doors are foamed-in-place using high density, CFC free polyurethane insulation.

■ **Thermostatic expansion valves**

■ **Refrigerator holds 33°F ~ 38°F for the best in food preservation**

■ **Standard features**

- Top mount compressor
- USB temperature data storage
- Anti-corrosion coated evaporator
- Easily replaceable one-piece magnetic door gaskets
- Self-contained system
- Solid and sturdy grille design
- Door locks
- 4" dia. swivel casters with locks on the front set

■ **Optional features**

- Legs available for all models
- Tray slides available

PRO-R MODELS SPECIFICATIONS

ELECTRICAL DATA	PRO-26-2R-N	PRO-50-4R-N	PRO-77-6R-N
Voltage	115/60/1	115/60/1	115/60/1
Plug Type	Ⓜ NEMA 5-15P	Ⓜ NEMA 5-15P	Ⓜ NEMA 5-15P
Full Load Amp.	7.0	8.0	9.0
Compressor HP	1/2	1/2	1
Cord Length (ft.)	9	9	9
Refrigerant	R-290	R-290	R-290
DIMENSIONAL DATA			
Net Capacity (cu. ft.)	24.76	47.57	74.78
Ext. Dimension (L x D x H†) (in.)	28 ³ / ₄ x 34 ¹ / ₈ x 78	51 ³ / ₄ x 34 ¹ / ₈ x 78	77 ³ / ₄ x 34 ¹ / ₈ x 78
Int. Dimension (L x D x H) (in.)	23 ⁷ / ₈ x 27 ⁵ / ₈ x 58 ³ / ₄	46 ³ / ₄ x 27 ⁵ / ₈ x 58 ³ / ₄	72 ⁷ / ₈ x 27 ⁵ / ₈ x 58 ³ / ₄
# of Doors	2	4	6
# of Racks Accepted	1	2	3
# of Shelves (Size (L x D) (in.))	3 (23 ¹ / ₂ x 26 ³ / ₈)	6 (22 ³ / ₄ x 26 ³ / ₈ (L/R))	9 (22 ³ / ₄ x 26 ³ / ₈ (L/R), 25 x 26 ³ / ₈ (M))
Net Weight (lbs.)	341	517	659
Gross Weight (lbs.)	384	570	734

Design and specifications subject to change without notice. Most updated spec sheets are available at www.turboairinc.com.

Actual shipping weight may differ due to extra packing materials for product protection.

* Depth does not include 1-1/4" for door handles. † Height does not include 5" for caster height.

■ **WARRANTY: 5 Year Parts and Labor Warranty, 7 Year Compressor Warranty**

SOLID/HALF SOLID DOOR FREEZERS NATURAL Refrigerant

Self-Cleaning Condenser Equipped Units

Self-Cleaning Condenser (Patented)

The accumulation of dust in the condenser can cause the failure or breakdown of refrigerators. Refrigerators run normally until they reach a certain level of accumulation. At some point, when they are over the limit, their performance drops quickly resulting in damage to, or disposal of the stored products inside. The Self-Cleaning Condenser device keeps the condenser clean and prevents system failure by automatically brushing daily.

Digital temperature control & monitor system

- Keeps food products safe by maintaining constant temperatures
- Alarms that sound when doors are not sealed shut; protects against food spoilage that originates from cold air leaks
- Early warning alarm program detects issues before malfunction occurs
- Digital display allows for easy monitoring
- Programs interpret the condition of refrigeration systems by self-diagnosis
- Smart defrost system will defrost as needed
- Rapid cool-down function (Turbo Freeze)
- Automatic evaporator fan motor delays

Hydrocarbon refrigerants (R-290)

With innovative and eco-friendly technology, Turbo Air brings you hydrocarbon refrigerators designed to meet DOE's Energy Conservation Standards in 2017 and to use EPA's SNAP Program approved HC refrigerants. Hydrocarbon refrigerants do not deplete the ozone layer and have very low contribution to global warming (ODP-0, GWP-3).

Cold air distribution system

Provides uniformly maintained temperature within the food zone.

Hot gas condensate system

Through Turbo Air's creative innovation, the condensate system surfaces have been specially treated to resist corrosion. This not only increases efficiency without the risk of refrigerant leakage from corrosion, but also prevents the overflow of condensate water.

All stainless steel cabinet construction

The PRO series model boasts a stainless steel interior and a 22 gauge stainless steel exterior (galvanized steel top, bottom). It guarantees the utmost in cleanliness and long product life. The PRO series model adds a touch of style to the most refined setting.

Sturdy, clean stainless steel shelving

Shelves are the most important part of cleanliness as they come in direct contact with food. After a while, PVC coated wire shelves may peel, rust and lead to unsanitary conditions. Only the Turbo Air PRO series uniquely provides stainless steel shelving.

Left hinged models available (PRO-15F-N-L, PRO-15-2F-N-L)

LED interior lighting

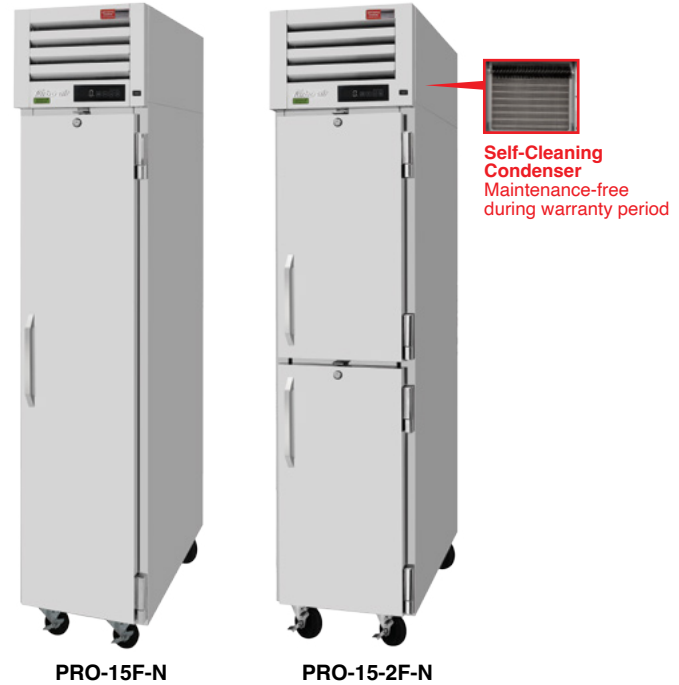

High-density polyurethane insulation

The entire cabinet structure and solid doors are foamed-in-place using high density, CFC free polyurethane insulation.

Freezer holds -10°F ~ 0°F for the best in frozen food preservation

Standard features

- Top mount compressor
- USB temperature data storage
- Anti-corrosion coated evaporator
- Easily replaceable one-piece magnetic door gaskets
- Self-contained system
- Solid and sturdy grille design
- Door locks
- 4" dia. swivel casters with locks on the front set
- Lead time applies

Optional features

- Legs available for all models

PRO-F MODELS SPECIFICATIONS

ELECTRICAL DATA	PRO-15F-N	PRO-15-2F-N
Voltage	115/60/1	115/60/1
Plug Type	Ⓜ NEMA 5-15P	Ⓜ NEMA 5-15P
Full Load Amp.	4.5	4.5
Compressor HP	1/2	1/2
Cord Length (ft.)	9	9
Refrigerant	R-290	R-290
DIMENSIONAL DATA		
Net Capacity (cu. ft.)	12.67	12.67
Ext. Dimension (L x D x H†) (in.)	17 ³ / ₄ x 34 ³ / ₈ x 78	17 ³ / ₄ x 34 ³ / ₈ x 78
Int. Dimension (L x D x H) (in.)	13 ³ / ₄ x 26 ⁵ / ₈ x 52 ³ / ₄	13 ³ / ₄ x 26 ⁵ / ₈ x 52 ³ / ₄
# of Doors	1	2
# of Racks Accepted	-	-
# of Shelves (Size (L x D) (in.))	3 (12 ¹ / ₂ x 25 ¹ / ₈)	3 (12 ¹ / ₂ x 25 ¹ / ₈)
Net Weight (lbs.)	259	259
Gross Weight (lbs.)	300	300

Design and specifications subject to change without notice. Most updated spec sheets are available at www.turboairinc.com.

Actual shipping weight may differ due to extra packing materials for product protection.

* Depth does not include 4-1/8" for door handles and rear condensate enclosure. † Height does not include 5" for caster height.

WARRANTY: 5 Year Parts and Labor Warranty, 7 Year Compressor Warranty

SOLID DOOR FREEZERS **NATURAL Refrigerant**

Self-Cleaning Condenser Equipped Units

Self-Cleaning Condenser (Patented)

The accumulation of dust in the condenser can cause the failure or breakdown of refrigerators. Refrigerators run normally until they reach a certain level of accumulation. At some point, when they are over the limit, their performance drops quickly resulting in damage to, or disposal of the stored products inside. The Self-Cleaning Condenser device keeps the condenser clean and prevents system failure by automatically brushing daily.

Digital temperature control & monitor system

- Keeps food products safe by maintaining constant temperatures
- Alarms that sound when doors are not sealed shut; protects against food spoilage that originates from cold air leaks
- Early warning alarm program detects issues before malfunction occurs
- Digital display allows for easy monitoring
- Programs interpret the condition of refrigeration systems by self-diagnosis
- Smart defrost system will defrost as needed
- Rapid cool-down function (Turbo Freeze)
- Automatic evaporator fan motor delays

Hydrocarbon refrigerants (R-290)

With innovative and eco-friendly technology, Turbo Air brings you hydrocarbon refrigerators designed to meet DOE's Energy Conservation Standards in 2017 and to use EPA's SNAP Program approved HC refrigerants. Hydrocarbon refrigerants do not deplete the ozone layer and have very low contribution to global warming (ODP-0, GWP-3).

Cold air distribution system

Provides uniformly maintained temperature within the food zone.

Hot gas condensate system

Through Turbo Air's creative innovation, the condensate system surfaces have been specially treated to resist corrosion. This not only increases efficiency without the risk of refrigerant leakage from corrosion, but also prevents the overflow of condensate water.

All stainless steel cabinet construction

The PRO series model boasts a stainless steel interior and a 22 gauge stainless steel exterior (galvanized steel top, bottom). It guarantees the utmost in cleanliness and long product life. The PRO series model adds a touch of style to the most refined setting.

Sturdy, clean stainless steel shelving

Shelves are the most important part of cleanliness as they come in direct contact with food. After a while, PVC coated wire shelves may peel, rust and lead to unsanitary conditions. Only the Turbo Air PRO series uniquely provides stainless steel shelving.

Left hinged (PRO-26F-N-L), all left hinged (PRO-77F-N-AL), all right hinged (PRO-77F-N-AR) models available

LED interior lighting

Self-Cleaning Condenser
Maintenance-free
during warranty period



PRO-26F-N



PRO-50F-N

High-density polyurethane insulation

The entire cabinet structure and solid doors are foamed-in-place using high density, CFC free polyurethane insulation.

Thermostatic expansion valves

Freezer holds -10°F ~ 0°F for the best in frozen food preservation

Standard features

- Top mount compressor
- USB temperature data storage
- Anti-corrosion coated evaporator
- Easily replaceable one-piece magnetic door gaskets
- Self-contained system
- Solid and sturdy grille design
- Door locks
- 4" dia. swivel casters with locks on the front set
- Thermostatic expansion valves

Optional features

- Legs available for all models
- Tray slides available

PRO-F MODELS SPECIFICATIONS

ELECTRICAL DATA	PRO-26F-N	PRO-50F-N	PRO-77F-N
Voltage	115/60/1	115/60/1	115/60/1
Plug Type	Ⓜ NEMA 5-15P	Ⓜ NEMA 5-15P	Ⓜ NEMA 5-20P
Full Load Amp.	7.0	9.0	15.0
Compressor HP	1/2	1	1/2 x 2
Cord Length (ft.)	9	9	9
Refrigerant	R-290	R-290	R-290
DIMENSIONAL DATA			
Net Capacity (cu. ft.)	25.35	48.36	74.94
Ext. Dimension (L x D x H†) (in.)	28 ³ / ₄ x 34 ¹ / ₈ x 78	51 ³ / ₄ x 34 ¹ / ₈ x 78	77 ³ / ₄ x 34 ¹ / ₈ x 78
Int. Dimension (L x D x H) (in.)	23 ⁷ / ₈ x 27 ⁵ / ₈ x 58 ³ / ₄	46 ³ / ₄ x 27 ⁵ / ₈ x 58 ³ / ₄	72 ⁷ / ₈ x 27 ⁵ / ₈ x 58 ³ / ₄
# of Doors	1	2	3
# of Racks Accepted	1	2	3
# of Shelves (Size (L x D) (in.))	3 (23 ¹ / ₂ x 26 ³ / ₈)	6 (22 ³ / ₄ x 26 ³ / ₈ (L/R))	9 (22 ³ / ₄ x 26 ³ / ₈ (L/R), 25 x 26 ³ / ₈ (M))
Net Weight (lbs.)	315	485	663
Gross Weight (lbs.)	358	538	738

Design and specifications subject to change without notice. Most updated spec sheets are available at www.turboairinc.com.

Actual shipping weight may differ due to extra packing materials for product protection.

* Depth does not include 1-1/4" for door handles. † Height does not include 5" for caster height.

WARRANTY: 5 Year Parts and Labor Warranty, 7 Year Compressor Warranty

HALF SOLID DOOR FREEZERS NATURAL Refrigerant

Self-Cleaning Condenser Equipped Units

Self-Cleaning Condenser
Maintenance-free
during warranty period



■ **Self-Cleaning Condenser (Patented)**

The accumulation of dust in the condenser can cause the failure or breakdown of refrigerators. Refrigerators run normally until they reach a certain level of accumulation. At some point, when they are over the limit, their performance drops quickly resulting in damage to, or disposal of the stored products inside. The Self-Cleaning Condenser device keeps the condenser clean and prevents system failure by automatically brushing daily.

■ **Digital temperature control & monitor system**

- Keeps food products safe by maintaining constant temperatures
- Alarms that sound when doors are not sealed shut; protects against food spoilage that originates from cold air leaks
- Early warning alarm program detects issues before malfunction occurs
- Digital display allows for easy monitoring
- Programs interpret the condition of refrigeration systems by self-diagnosis
- Smart defrost system will defrost as needed
- Rapid cool-down function (Turbo Freeze)
- Automatic evaporator fan motor delays

■ **Hydrocarbon refrigerants (R-290)**

With innovative and eco-friendly technology, Turbo Air brings you hydrocarbon refrigerators designed to meet DOE's Energy Conservation Standards in 2017 and to use EPA's SNAP Program approved HC refrigerants. Hydrocarbon refrigerants do not deplete the ozone layer and have very low contribution to global warming (ODP-0, GWP-3).

■ **Cold air distribution system**

Provides uniformly maintained temperature within the food zone.

■ **Hot gas condensate system**

Through Turbo Air's creative innovation, the condensate system surfaces have been specially treated to resist corrosion. This not only increases efficiency without the risk of refrigerant leakage from corrosion, but also prevents the overflow of condensate water.

■ **All stainless steel cabinet construction**

The PRO series model boasts a stainless steel interior and a 22 gauge stainless steel exterior (galvanized steel top, bottom). It guarantees the utmost in cleanliness and long product life. The PRO series model adds a touch of style to the most refined setting.

■ **Sturdy, clean stainless steel shelving**

Shelves are the most important part of cleanliness as they come in direct contact with food. After a while, PVC coated wire shelves may peel, rust and lead to unsanitary conditions. Only the Turbo Air PRO series uniquely provides stainless steel shelving.

■ **Left hinged (PRO-26-2F-N-L), all left hinged (PRO-50-4F-N-AL) models available**

■ **LED interior lighting**

■ **High-density polyurethane insulation**

The entire cabinet structure and solid doors are foamed-in-place using high density, CFC free polyurethane insulation.

■ **Thermostatic expansion valves**

■ **Freezer holds -10°F ~ 0°F for the best in frozen food preservation**

■ **Standard features**

- Top mount compressor
- USB temperature data storage
- Anti-corrosion coated evaporator
- Easily replaceable one-piece magnetic door gaskets
- Self-contained system
- Solid and sturdy grille design
- Door locks
- 4" dia. swivel casters with locks on the front set

■ **Optional features**

- Legs available for all models
- Tray slides available

PRO-F MODELS SPECIFICATIONS

ELECTRICAL DATA	PRO-26-2F-N	PRO-50-4F-N
Voltage	115/60/1	115/60/1
Plug Type	Ⓜ NEMA 5-15P	Ⓜ NEMA 5-15P
Full Load Amp.	7.0	9.0
Compressor HP	1/2	1/2
Cord Length (ft.)	9	9
Refrigerant	R-290	R-290
DIMENSIONAL DATA		
Net Capacity (cu. ft.)	24.39	48.06
Ext. Dimension (L x D [†] x H [†]) (in.)	28 ³ / ₄ x 34 ¹ / ₈ x 78	51 ³ / ₄ x 34 ¹ / ₈ x 78
Int. Dimension (L x D x H) (in.)	23 ⁷ / ₈ x 27 ⁵ / ₈ x 58 ³ / ₄	46 ³ / ₄ x 27 ⁵ / ₈ x 58 ³ / ₄
# of Doors	2	4
# of Racks Accepted	1	2
# of Shelves (Size (L x D) (in.))	3 (23 ¹ / ₂ x 26 ³ / ₈)	6 (22 ³ / ₄ x 26 ³ / ₈ (L/R))
Net Weight (lbs.)	323	496
Gross Weight (lbs.)	366	549

Design and specifications subject to change without notice. Most updated spec sheets are available at www.turboairinc.com.

Actual shipping weight may differ due to extra packing materials for product protection.

* Depth does not include 1-1/4" for door handles. † Height does not include 5" for caster height.

■ **WARRANTY: 5 Year Parts and Labor Warranty, 7 Year Compressor Warranty**

GLASS & SOLID HALF DOOR REFRIGERATORS NATURAL Refrigerant

Self-Cleaning Condenser Equipped Units

Self-Cleaning Condenser (Patented)

The accumulation of dust in the condenser can cause the failure or breakdown of refrigerators. Refrigerators run normally until they reach a certain level of accumulation. At some point, when they are over the limit, their performance drops quickly resulting in damage to, or disposal of the stored products inside. The Self-Cleaning Condenser device keeps the condenser clean and prevents system failure by automatically brushing daily.

Digital temperature control & monitor system

- Keeps food products safe by maintaining constant temperatures
- Alarms that sound when doors are not sealed shut; protects against food spoilage that originates from cold air leaks
- Early warning alarm program detects issues before malfunction occurs
- Digital display allows for easy monitoring
- Programs interpret the condition of refrigeration systems by self-diagnosis
- Rapid cool-down function (Turbo Cooling)
- Automatic evaporator fan motor delays

Hydrocarbon refrigerants (R-290)

With innovative and eco-friendly technology, Turbo Air brings you hydrocarbon refrigerators designed to meet DOE's Energy Conservation Standards in 2017 and to use EPA's SNAP Program approved HC refrigerants. Hydrocarbon refrigerants do not deplete the ozone layer and have very low contribution to global warming (ODP-0, GWP-3).

Cold air distribution system

Provides uniformly maintained temperature within the food zone.

Hot gas condensate system

Through Turbo Air's creative innovation, the condensate system surfaces have been specially treated to resist corrosion. This not only increases efficiency without the risk of refrigerant leakage from corrosion, but also prevents the overflow of condensate water.

All stainless steel cabinet construction

The PRO series model boasts a stainless steel interior and a 22 gauge stainless steel exterior (galvanized steel top, bottom). It guarantees the utmost in cleanliness and long product life. The PRO series model adds a touch of style to the most refined setting.

Sturdy, clean stainless steel shelving

Shelves are the most important part of cleanliness as they come in direct contact with food. After a while, PVC coated wire shelves may peel, rust and lead to unsanitary conditions. Only the Turbo Air PRO series uniquely provides stainless steel shelving.

High-density polyurethane insulation

The entire cabinet structure and solid doors are foamed-in-place using high density, CFC free polyurethane insulation.

Left hinged model available (PRO-26R-GSH-N-L)

Self-Cleaning Condenser
Maintenance-free
during warranty period



PRO-26R-GSH-N

PRO-50R-GSH-N

LED interior lighting

Thermostatic expansion valves

Refrigerator holds 33°F ~ 38°F for the best in food preservation

Standard features

- Top mount compressor
- USB temperature data storage
- Anti-corrosion coated evaporator
- Easily replaceable one-piece magnetic door gaskets
- Self-contained system
- Solid and sturdy grille design
- Door locks
- 4" dia. swivel casters with locks on the front set
- Lead time applies

Optional features

- Legs available for all models
- Tray slides available

PRO-R-GSH MODELS SPECIFICATIONS

ELECTRICAL DATA	PRO-26R-GSH-N	PRO-50R-GSH-N
Voltage	115/60/1	115/60/1
Plug Type	Ⓢ NEMA 5-15P	Ⓢ NEMA 5-15P
Full Load Amp.	7.0	8.0
Compressor HP	1/2	1/2
Cord Length (ft.)	9	9
Refrigerant	R-290	R-290
DIMENSIONAL DATA		
Net Capacity (cu. ft.)	25.15	50.8
Ext. Dimension (L x D x H†) (in.)	28 ³ / ₄ x 34 ¹ / ₈ x 78	51 ³ / ₄ x 34 ¹ / ₈ x 78
Int. Dimension (L x D x H) (in.)	23 ⁷ / ₈ x 27 ⁵ / ₈ x 58 ³ / ₄	46 ³ / ₄ x 27 ⁵ / ₈ x 58 ³ / ₄
# of Doors	2	4
# of Racks Accepted	1	2
# of Shelves (Size (L x D) (in.))	3 (23 ¹ / ₂ x 26 ³ / ₈)	6 (22 ³ / ₄ x 26 ³ / ₈ (L/R))
Net Weight (lbs.)	320	507
Gross Weight (lbs.)	394	564

Design and specifications subject to change without notice. Most updated spec sheets are available at www.turboairinc.com.

Actual shipping weight may differ due to extra packing materials for product protection.

* Depth does not include 1-1/4" for door handles. † Height does not include 5" for caster height.

WARRANTY: 5 Year Parts and Labor Warranty, 7 Year Compressor Warranty

GLASS / HALF GLASS DOOR REFRIGERATORS NATURAL Refrigerant

Self-Cleaning Condenser Equipped Units

Self-Cleaning Condenser (Patented)

The accumulation of dust in the condenser can cause the failure or breakdown of refrigerators. Refrigerators run normally until they reach a certain level of accumulation. At some point, when they are over the limit, their performance drops quickly resulting in damage to, or disposal of the stored products inside. The Self-Cleaning Condenser device keeps the condenser clean and prevents system failure by automatically brushing daily.

Digital temperature control & monitor system

- Keeps food products safe by maintaining constant temperatures
- Alarms that sound when doors are not sealed shut; protects against food spoilage that originates from cold air leaks
- Early warning alarm program detects issues before malfunction occurs
- Digital display allows for easy monitoring
- Programs interpret the condition of refrigeration systems by self-diagnosis
- Rapid cool-down function (Turbo Cooling)
- Automatic evaporator fan motor delays

Hydrocarbon refrigerants (R-290)

With innovative and eco-friendly technology, Turbo Air brings you hydrocarbon refrigerators designed to meet DOE's Energy Conservation Standards in 2017 and to use EPA's SNAP Program approved HC refrigerants. Hydrocarbon refrigerants do not deplete the ozone layer and have very low contribution to global warming (ODP-0, GWP-3).

Cold air distribution system

Provides uniformly maintained temperature within the food zone.

Hot gas condensate system

Through Turbo Air's creative innovation, the condensate system surfaces have been specially treated to resist corrosion. This not only increases efficiency without the risk of refrigerant leakage from corrosion, but also prevents the overflow of condensate water.

All stainless steel cabinet construction

The PRO series model boasts a stainless steel interior and a 22 gauge stainless steel exterior (galvanized steel top, bottom). It guarantees the utmost in cleanliness and long product life. The PRO series model adds a touch of style to the most refined setting.

Sturdy, clean stainless steel shelving

Shelves are the most important part of cleanliness as they come in direct contact with food. After a while, PVC coated wire shelves may peel, rust and lead to unsanitary conditions. Only the Turbo Air PRO series uniquely provides stainless steel shelving.

High-density polyurethane insulation

The entire cabinet structure and solid doors are foamed-in-place using high density, CFC free polyurethane insulation.



PRO-12R-G-N

PRO-15-2R-G-N

LED interior lighting

Left hinged models available (PRO-12R-G-N-L, PRO-15R-G-N-L, PRO-12-2R-G-N-L, PRO-15-2R-G-N-L)

Refrigerator holds 33°F ~ 38°F for the best in food preservation

Standard features

- Top mount compressor
- USB temperature data storage
- Anti-corrosion coated evaporator
- Easily replaceable one-piece magnetic door gaskets
- Self-contained system
- Solid and sturdy grille design
- Door locks
- 4" dia. swivel casters with locks on the front set
- Lead time applies

Optional features

- Legs available for all models

PRO-R-G MODELS SPECIFICATIONS

ELECTRICAL DATA	PRO-12R-G-N	PRO-15R-G-N	PRO-12-2R-G-N	PRO-15-2R-G-N
Voltage	115/60/1	115/60/1	115/60/1	115/60/1
Plug Type	Ⓜ NEMA 5-15P	Ⓜ NEMA 5-15P	Ⓜ NEMA 5-15P	Ⓜ NEMA 5-15P
Full Load Amp.	2.5	2.5	2.5	2.5
Compressor HP	1/4+	1/4+	1/4+	1/4+
Cord Length (ft.)	9	9	9	9
Refrigerant	R-290	R-290	R-290	R-290
DIMENSIONAL DATA				
Net Capacity (cu. ft.)	9.47	13.34	9.4	12.5
Ext. Dimension (L x D x H†) (in.)	17 ³ / ₄ x 27 ¹ / ₄ x 78	17 ³ / ₄ x 34 ³ / ₈ x 78	17 ³ / ₄ x 27 ¹ / ₄ x 78	17 ³ / ₄ x 34 ³ / ₈ x 78
Int. Dimension (L x D x H) (in.)	13 ³ / ₄ x 20 ¹ / ₄ x 52 ³ / ₄	13 ³ / ₄ x 26 ⁵ / ₈ x 52 ³ / ₄	13 ³ / ₄ x 20 ¹ / ₄ x 52 ³ / ₄	13 ³ / ₄ x 26 ⁵ / ₈ x 52 ³ / ₄
# of Doors	1	1	2	2
# of Racks Accepted	-	-	-	-
# of Shelves (Size (L x D) (in.))	3 (12 ¹ / ₂ x 18 ³ / ₄)	3 (12 ¹ / ₂ x 25 ¹ / ₈)	3 (12 ¹ / ₂ x 18 ³ / ₄)	3 (12 ¹ / ₂ x 25 ¹ / ₈)
Net Weight (lbs.)	188	266	188	266
Gross Weight (lbs.)	223	300	223	300

Design and specifications subject to change without notice. Most updated spec sheets are available at www.turboairinc.com.

Actual shipping weight may differ due to extra packing materials for product protection.

* Depth does not include 4" for door handles & rear condensate enclosure. † Height does not include 5" for caster height.

■ **WARRANTY: 5 Year Parts and Labor Warranty, 7 Year Compressor Warranty**

GLASS DOOR REFRIGERATORS NATURAL Refrigerant

Self-Cleaning Condenser Equipped Units

Self-Cleaning Condenser (Patented)

The accumulation of dust in the condenser can cause the failure or breakdown of refrigerators. Refrigerators run normally until they reach a certain level of accumulation. At some point, when they are over the limit, their performance drops quickly resulting in damage to, or disposal of the stored products inside. The Self-Cleaning Condenser device keeps the condenser clean and prevents system failure by automatically brushing daily.

Digital temperature control & monitor system

- Keeps food products safe by maintaining constant temperatures
- Alarms that sound when doors are not sealed shut; protects against food spoilage that originates from cold air leaks
- Early warning alarm program detects issues before malfunction occurs
- Digital display allows for easy monitoring
- Programs interpret the condition of refrigeration systems by self-diagnosis
- Rapid cool-down function (Turbo Cooling)
- Automatic evaporator fan motor delays

Hydrocarbon refrigerants (R-290)

With innovative and eco-friendly technology, Turbo Air brings you hydrocarbon refrigerators designed to meet DOE's Energy Conservation Standards in 2017 and to use EPA's SNAP Program approved HC refrigerants. Hydrocarbon refrigerants do not deplete the ozone layer and have very low contribution to global warming (ODP-0, GWP-3).

Cold air distribution system

Provides uniformly maintained temperature within the food zone.

Hot gas condensate system

Through Turbo Air's creative innovation, the condensate system surfaces have been specially treated to resist corrosion. This not only increases efficiency without the risk of refrigerant leakage from corrosion, but also prevents the overflow of condensate water.

All stainless steel cabinet construction

The PRO series model boasts a stainless steel interior and a 22 gauge stainless steel exterior (galvanized steel top, bottom). It guarantees the utmost in cleanliness and long product life. The PRO series model adds a touch of style to the most refined setting.

Sturdy, clean stainless steel shelving

Shelves are the most important part of cleanliness as they come in direct contact with food. After a while, PVC coated wire shelves may peel, rust and lead to unsanitary conditions. Only the Turbo Air PRO series uniquely provides stainless steel shelving.

High-density polyurethane insulation

The entire cabinet structure and solid doors are foamed-in-place using high density, CFC free polyurethane insulation.

LED interior lighting

Self-Cleaning Condenser
Maintenance-free
during warranty period



Left hinged model available (PRO-26R-G-N-L)

Thermostatic expansion valves

Refrigerator holds 33°F ~ 38°F for the best in food preservation

Standard features

- Top mount compressor
- USB temperature data storage
- Anti-corrosion coated evaporator
- Easily replaceable one-piece magnetic door gaskets
- Self-contained system
- Solid and sturdy grille design
- Door locks
- 4" dia. swivel casters with locks on the front set
- Lead time applies

Optional features

- Legs available for all models
- Tray slides available

PRO-R-G MODELS SPECIFICATIONS

ELECTRICAL DATA	PRO-26R-G-N	PRO-50R-G-N	PRO-77R-G-N
Voltage	115/60/1	115/60/1	115/60/1
Plug Type	Ⓜ NEMA 5-15P	Ⓜ NEMA 5-15P	Ⓜ NEMA 5-15P
Full Load Amp.	7.0	8.0	9.0
Compressor HP	1/2	1/2	1
Cord Length (ft.)	9	9	9
Refrigerant	R-290	R-290	R-290
DIMENSIONAL DATA			
Net Capacity (cu. ft.)	25.73	47.36	75.69
Ext. Dimension (L x D x H*) (in.)	28 ³ / ₄ x 34 ¹ / ₈ x 78	51 ³ / ₄ x 34 ¹ / ₈ x 78	77 ³ / ₄ x 34 ¹ / ₈ x 78
Int. Dimension (L x D x H) (in.)	23 ⁷ / ₈ x 27 ⁵ / ₈ x 58 ³ / ₄	46 ³ / ₄ x 27 ⁵ / ₈ x 58 ³ / ₄	72 ⁷ / ₈ x 27 ⁵ / ₈ x 58 ³ / ₄
# of Doors	1	2	3
# of Racks Accepted	1	2	3
# of Shelves (Size (L x D) (in.))	3 (23 ¹ / ₂ x 26 ³ / ₈)	6 (22 ³ / ₄ x 26 ³ / ₈ (L/R))	9 (22 ³ / ₄ x 26 ³ / ₈ (L/R), 25 x 26 ³ / ₈ (M))
Net Weight (lbs.)	343	489	649
Gross Weight (lbs.)	386	552	724

Design and specifications subject to change without notice. Most updated spec sheets are available at www.turboairinc.com.

Actual shipping weight may differ due to extra packing materials for product protection.

* Depth does not include 1-1/4" for door handles. † Height does not include 5" for caster height.

WARRANTY: 5 Year Parts and Labor Warranty, 7 Year Compressor Warranty

HALF GLASS DOOR REFRIGERATORS

NATURAL Refrigerant

Self-Cleaning Condenser Equipped Units

Self-Cleaning Condenser
Maintenance-free
during warranty period

■ **Self-Cleaning Condenser (Patented)**

The accumulation of dust in the condenser can cause the failure or breakdown of refrigerators. Refrigerators run normally until they reach a certain level of accumulation. At some point, when they are over the limit, their performance drops quickly resulting in damage to, or disposal of the stored products inside. The Self-Cleaning Condenser device keeps the condenser clean and prevents system failure by automatically brushing daily.

■ **Digital temperature control & monitor system**

- Keeps food products safe by maintaining constant temperatures
- Alarms that sound when doors are not sealed shut; protects against food spoilage that originates from cold air leaks
- Early warning alarm program detects issues before malfunction occurs
- Digital display allows for easy monitoring
- Programs interpret the condition of refrigeration systems by self-diagnosis
- Rapid cool-down function (Turbo Cooling)
- Automatic evaporator fan motor delays

■ **Hydrocarbon refrigerants (R-290)**

With innovative and eco-friendly technology, Turbo Air brings you hydrocarbon refrigerators designed to meet DOE's Energy Conservation Standards in 2017 and to use EPA's SNAP Program approved HC refrigerants. Hydrocarbon refrigerants do not deplete the ozone layer and have very low contribution to global warming (ODP-0, GWP-3).

■ **Cold air distribution system**

Provides uniformly maintained temperature within the food zone.

■ **Hot gas condensate system**

Through Turbo Air's creative innovation, the condensate system surfaces have been specially treated to resist corrosion. This not only increases efficiency without the risk of refrigerant leakage from corrosion, but also prevents the overflow of condensate water.

■ **All stainless steel cabinet construction**

The PRO series model boasts a stainless steel interior and a 22 gauge stainless steel exterior (galvanized steel top, bottom). It guarantees the utmost in cleanliness and long product life. The PRO series model adds a touch of style to the most refined setting.

■ **Sturdy, clean stainless steel shelving**

Shelves are the most important part of cleanliness as they come in direct contact with food. After a while, PVC coated wire shelves may peel, rust and lead to unsanitary conditions. Only the Turbo Air PRO series uniquely provides stainless steel shelving.

■ **High-density polyurethane insulation**

The entire cabinet structure and solid doors are foamed-in-place using high density, CFC free polyurethane insulation.

■ **LED interior lighting**



PRO-26-2R-G-N



PRO-50-4R-G-N

■ **Left hinged model available (PRO-26-2R-G-N-L)**

■ **Thermostatic expansion valves**

■ **Refrigerator holds 33°F ~ 38°F for the best in food preservation**

■ **Standard features**

- Top mount compressor
- USB temperature data storage
- Anti-corrosion coated evaporator
- Easily replaceable one-piece magnetic door gaskets
- Self-contained system
- Solid and sturdy grille design
- Door locks
- 4" dia. swivel casters with locks on the front set
- Lead time applies

■ **Optional features**

- Legs available for all models
- Tray slides available

PRO-R-G MODELS SPECIFICATIONS

ELECTRICAL DATA	PRO-26-2R-G-N	PRO-50-4R-G-N	PRO-77-6R-G-N
Voltage	115/60/1	115/60/1	115/60/1
Plug Type	Ⓢ NEMA 5-15P	Ⓢ NEMA 5-15P	Ⓢ NEMA 5-15P
Full Load Amp.	7.0	8.0	9.0
Compressor HP	1/2	1/2	1
Cord Length (ft.)	9	9	9
Refrigerant	R-290	R-290	R-290
DIMENSIONAL DATA			
Net Capacity (cu. ft.)	25.73	47.36	75.2
Ext. Dimension (L x D x H [†]) (in.)	28 ³ / ₄ x 34 ¹ / ₈ x 78	51 ³ / ₄ x 34 ¹ / ₈ x 78	77 ³ / ₄ x 34 ¹ / ₈ x 78
Int. Dimension (L x D x H) (in.)	23 ⁷ / ₈ x 27 ⁵ / ₈ x 58 ³ / ₄	46 ³ / ₄ x 27 ⁵ / ₈ x 58 ³ / ₄	72 ⁷ / ₈ x 27 ⁵ / ₈ x 58 ³ / ₄
# of Doors	2	4	6
# of Racks Accepted	1	2	3
# of Shelves (Size (L x D) (in.))	3 (23 ¹ / ₂ x 26 ³ / ₈)	6 (22 ³ / ₄ x 26 ³ / ₈ (L/R))	9 (22 ³ / ₄ x 26 ³ / ₈ (L/R), 25 x 26 ³ / ₈ (M))
Net Weight (lbs.)	349	495	649
Gross Weight (lbs.)	386	552	764

Design and specifications subject to change without notice. Most updated spec sheets are available at www.turboairinc.com.

Actual shipping weight may differ due to extra packing materials for product protection.

* Depth does not include 1-1/4" for door handles. † Height does not include 5" for caster height.

■ **WARRANTY: 5 Year Parts and Labor Warranty, 7 Year Compressor Warranty**

HALF SOLID/GLASS DOOR REFRIGERATORS - DRAWERS

Self-Cleaning Condenser Equipped Units

Self-Cleaning Condenser (Patented)

The accumulation of dust in the condenser can cause the failure or breakdown of refrigerators. Refrigerators run normally until they reach a certain level of accumulation. At some point, when they are over the limit, their performance drops quickly resulting in damage to, or disposal of the stored products inside. The Self-Cleaning Condenser device keeps the condenser clean and prevents system failure by automatically brushing daily.

Digital temperature control & monitor system

- Keeps food products safe by maintaining constant temperatures
- Alarms that sound when doors are not sealed shut; protects against food spoilage that originates from cold air leaks (except PRO-26R-D4-N)
- Early warning alarm program detects issues before malfunction occurs
- Digital display allows for easy monitoring
- Programs interpret the condition of refrigeration systems by self-diagnosis
- Rapid cool-down function (Turbo Cooling)
- Automatic evaporator fan motor delays

Hydrocarbon refrigerants (R-290)

With innovative and eco-friendly technology, Turbo Air brings you hydrocarbon refrigerators designed to meet DOE's Energy Conservation Standards in 2017 and to use EPA's SNAP Program approved HC refrigerants. Hydrocarbon refrigerants do not deplete the ozone layer and have very low contribution to global warming (ODP-0, GWP-3).

Cold air distribution system

Provides uniformly maintained temperature within the food zone.

Hot gas condensate system

Through Turbo Air's creative innovation, the condensate system surfaces have been specially treated to resist corrosion. This not only increases efficiency without the risk of refrigerant leakage from corrosion, but also prevents the overflow of condensate water.

All stainless steel cabinet construction

The PRO series model boasts a stainless steel interior and a 22 gauge stainless steel exterior (galvanized steel top, bottom). It guarantees the utmost in cleanliness and long product life. The PRO series model adds a touch of style to the most refined setting.

Sturdy, clean stainless steel shelving

Shelves are the most important part of cleanliness as they come in direct contact with food. After a while, PVC coated wire shelves may peel, rust and lead to unsanitary conditions. Only the Turbo Air PRO series uniquely provides stainless steel shelving (only PRO-26R-D2-N, PRO-26R-G-D2-N).

LED interior lighting (only PRO-26R-D2-N, PRO-26R-G-D2-N)

Self-Cleaning Condenser
Maintenance-free
during warranty period



PRO-26R-D4-N



PRO-26R-G-D2-N

High-density polyurethane insulation

The entire cabinet structure and solid doors are foamed-in-place using high density, CFC free polyurethane insulation.

Thermostatic expansion valves

Refrigerator holds 33°F ~ 38°F for the best in food preservation

Standard features

- Top mount compressor
- USB temperature data storage
- Anti-corrosion coated evaporator
- Self-contained system
- Solid and sturdy grille design
- Easily replaceable one-piece magnetic door & drawer gaskets
- Drawers accommodate 6" deep pans (pans not included)
- Door locks
- 4" dia. swivel casters with locks on the front set
- Lead time applies

Optional features

- Legs available for all models
- Tray slide kit available (only PRO-26R-D2-N, PRO-26R-G-D2-N)

PRO-R MODELS SPECIFICATIONS

ELECTRICAL DATA	PRO-26R-D2-N	PRO-26R-D4-N	PRO-26R-G-D2-N
Voltage	115/60/1	115/60/1	115/60/1
Plug Type	Ⓢ NEMA 5-15P	Ⓢ NEMA 5-15P	Ⓢ NEMA 5-15P
Full Load Amp.	7.0	7.0	7.0
Compressor HP	1/2	1/2	1/2
Cord Length (ft.)	9	9	9
Refrigerant	R-290	R-290	R-290
DIMENSIONAL DATA			
Net Capacity (cu. ft.)	24.76	25.41	25.73
Ext. Dimension (L x D [†] x H [†]) (in.)	28 ³ / ₄ x 34 ¹ / ₈ x 78	28 ³ / ₄ x 34 ¹ / ₈ x 78	28 ³ / ₄ x 34 ¹ / ₈ x 78
Int. Dimension (L x D x H) (in.)	23 ⁷ / ₈ x 27 ⁵ / ₈ x 58 ³ / ₄	23 ⁷ / ₈ x 27 ⁵ / ₈ x 58 ³ / ₄	23 ⁷ / ₈ x 27 ⁵ / ₈ x 58 ³ / ₄
# of Doors	1	-	1
# of Drawers	2	4	2
# of Shelves (Size (L x D) (in.))	2 (23 ¹ / ₂ x 26 ³ / ₈)	-	2 (23 ¹ / ₂ x 26 ³ / ₈)
Net Weight (lbs.)	309	309	320
Gross Weight (lbs.)	352	352	365

Design and specifications subject to change without notice. Most updated spec sheets are available at www.turboairinc.com.

Actual shipping weight may differ due to extra packing materials for product protection.

* Depth does not include 1-1/4" for drawer handles. † Height does not include 5" for caster height.

WARRANTY: 5 Year Parts and Labor Warranty, 7 Year Compressor Warranty

PASS-THRU SOLID DOOR REFRIGERATORS NATURAL Refrigerant

Self-Cleaning Condenser Equipped Units

Self-Cleaning Condenser
Maintenance-free during warranty period



PRO-26R-PT-N

PRO-50R-PT-N

- **Self-Cleaning Condenser (Patented)**
The accumulation of dust in the condenser can cause the failure or breakdown of refrigerators. Refrigerators run normally until they reach a certain level of accumulation. At some point, when they are over the limit, their performance drops quickly resulting in damage to, or disposal of the stored products inside. The Self-Cleaning Condenser device keeps the condenser clean and prevents system failure by automatically brushing daily.
- **Digital temperature control & monitor system**
 - Keeps food products safe by maintaining constant temperatures
 - Alarms that sound when doors are not sealed shut; protects against food spoilage that originates from cold air leaks
 - Early warning alarm program detects issues before malfunction occurs
 - Digital display allows for easy monitoring
 - Programs interpret the condition of refrigeration systems by self-diagnosis
 - Rapid cool-down function (Turbo Cooling)
 - Automatic evaporator fan motor delays
- **Hydrocarbon refrigerants (R-290)**
With innovative and eco-friendly technology, Turbo Air brings you hydrocarbon refrigerators designed to meet DOE's Energy Conservation Standards in 2017 and to use EPA's SNAP Program approved HC refrigerants. Hydrocarbon refrigerants do not deplete the ozone layer and have very low contribution to global warming (ODP-0, GWP-3).
- **Cold air distribution system**
Provides uniformly maintained temperature within the food zone.
- **Hot gas condensate system**
Through Turbo Air's creative innovation, the condensate system surfaces have been specially treated to resist corrosion. This not only increases efficiency without the risk of refrigerant leakage from corrosion, but also prevents the overflow of condensate water.
- **All stainless steel cabinet construction**
The PRO series model boasts a stainless steel interior and a 22 gauge stainless steel exterior (galvanized steel top, bottom). It guarantees the utmost in cleanliness and long product life. The PRO series model adds a touch of style to the most refined setting.
- **Sturdy, clean stainless steel shelving**
Shelves are the most important part of cleanliness as they come in direct contact with food. After a while, PVC coated wire shelves may peel, rust and lead to unsanitary conditions. Only the Turbo Air PRO series uniquely provides stainless steel shelving.
- **High-density polyurethane insulation**
The entire cabinet structure and solid doors are foamed-in-place using high density, CFC free polyurethane insulation.
- **Left hinged (PRO-26R-PT-N-L), front left hinged & back right hinged (PRO-26R-PT-N-LR), front right hinged & back left hinged (PRO-26R-PT-N-RL) models available**

- **LED interior lighting**
- **Thermostatic expansion valves**
- **Refrigerator holds 33°F ~ 38°F for the best in food preservation**
- **Standard features**
 - Top mount compressor
 - USB temperature data storage
 - Anti-corrosion coated evaporator
 - Easily replaceable one-piece magnetic door gaskets
 - Self-contained system
 - Solid and sturdy grille design
 - Door locks
 - 4" dia. swivel casters with locks on the front set
- **Optional features**
 - Legs available for all models
 - Tray slides available

PRO-R-PT MODELS SPECIFICATIONS

ELECTRICAL DATA	PRO-26R-PT-N	PRO-50R-PT-N
Voltage	115/60/1	115/60/1
Plug Type	Ⓢ NEMA 5-15P	Ⓢ NEMA 5-15P
Full Load Amp.	7.0	8.0
Compressor HP	1/2	1/2
Cord Length (ft.)	9	9
Refrigerant	R-290	R-290
DIMENSIONAL DATA		
Net Capacity (cu. ft.)	26.47	50.64
Ext. Dimension (L x D x H†) (in.)	28 ³ / ₄ x 36 ¹ / ₄ x 78	51 ³ / ₄ x 36 ¹ / ₄ x 78
Int. Dimension (L x D x H) (in.)	23 ⁷ / ₈ x 27 ⁵ / ₈ x 58 ³ / ₄	46 ³ / ₄ x 27 ⁵ / ₈ x 58 ³ / ₄
# of Doors	2	4
# of Racks Accepted	1	2
# of Shelves (Size (L x D) (in.))	3 (23 ¹ / ₂ x 26 ³ / ₈)	6 (22 ³ / ₄ x 26 ³ / ₈ (L/R))
Net Weight (lbs.)	320	527
Gross Weight (lbs.)	392	590

Design and specifications subject to change without notice. Most updated spec sheets are available at www.turboairinc.com.

Actual shipping weight may differ due to extra packing materials for product protection.

* Depth does not include 2-1/2" for door handles. † Height does not include 5" for caster height.

- **WARRANTY: 5 Year Parts and Labor Warranty, 7 Year Compressor Warranty**

PASS-THRU HALF SOLID DOOR REF. NATURAL Refrigerant

Self-Cleaning Condenser Equipped Units

■ **Self-Cleaning Condenser (Patented)**

The accumulation of dust in the condenser can cause the failure or breakdown of refrigerators. Refrigerators run normally until they reach a certain level of accumulation. At some point, when they are over the limit, their performance drops quickly resulting in damage to, or disposal of the stored products inside. The Self-Cleaning Condenser device keeps the condenser clean and prevents system failure by automatically brushing daily.

■ **Digital temperature control & monitor system**

- Keeps food products safe by maintaining constant temperatures
- Alarms that sound when doors are not sealed shut; protects against food spoilage that originates from cold air leaks
- Early warning alarm program detects issues before malfunction occurs
- Digital display allows for easy monitoring
- Programs interpret the condition of refrigeration systems by self-diagnosis
- Rapid cool-down function (Turbo Cooling)
- Automatic evaporator fan motor delays

■ **Hydrocarbon refrigerants (R-290)**

With innovative and eco-friendly technology, Turbo Air brings you hydrocarbon refrigerators designed to meet DOE's Energy Conservation Standards in 2017 and to use EPA's SNAP Program approved HC refrigerants. Hydrocarbon refrigerants do not deplete the ozone layer and have very low contribution to global warming (ODP-0, GWP-3).

■ **Cold air distribution system**

Provides uniformly maintained temperature within the food zone.

■ **Hot gas condensate system**

Through Turbo Air's creative innovation, the condensate system surfaces have been specially treated to resist corrosion. This not only increases efficiency without the risk of refrigerant leakage from corrosion, but also prevents the overflow of condensate water.

■ **All stainless steel cabinet construction**

The PRO series model boasts a stainless steel interior and a 22 gauge stainless steel exterior (galvanized steel top, bottom). It guarantees the utmost in cleanliness and long product life. The PRO series model adds a touch of style to the most refined setting.

■ **Sturdy, clean stainless steel shelving**

Shelves are the most important part of cleanliness as they come in direct contact with food. After a while, PVC coated wire shelves may peel, rust and lead to unsanitary conditions. Only the Turbo Air PRO series uniquely provides stainless steel shelving.

■ **High-density polyurethane insulation**

The entire cabinet structure and solid doors are foamed-in-place using high density, CFC free polyurethane insulation.

■ **LED interior lighting**

■ **Thermostatic expansion valves**

Self-Cleaning Condenser
Maintenance-free
during warranty period



PRO-26-2R-PT-N

PRO-50-4R-PT-N

■ **Refrigerator holds 33°F ~ 38°F for the best in food preservation**

■ **Left hinged model (PRO-26-2R-PT-N-L), front left hinged & back right hinged (PRO-26-2R-PT-N-LR), front right hinged & back left hinged (PRO-26-2R-PT-N-RL) models available**

■ **Standard features**

- Top mount compressor
- USB temperature data storage
- Anti-corrosion coated evaporator
- Easily replaceable one-piece magnetic door gaskets
- Self-contained system
- Solid and sturdy grille design
- Door locks
- 4" dia. swivel casters with locks on the front set

■ **Optional features**

- Legs available for all models
- Tray slides available

PRO-R-PT MODELS SPECIFICATIONS

ELECTRICAL DATA	PRO-26-2R-PT-N	PRO-50-4R-PT-N	PRO-77-6R-PT-N
Voltage	115/60/1	115/60/1	115/60/1
Plug Type	Ⓜ NEMA 5-15P	Ⓜ NEMA 5-15P	Ⓜ NEMA 5-15P
Full Load Amp.	7.0	8.0	9.0
Compressor HP	1/2	1/2	1
Cord Length (ft.)	9	9	9
Refrigerant	R-290	R-290	R-290
DIMENSIONAL DATA			
Net Capacity (cu. ft.)	26.27	50.27	77.63
Ext. Dimension (L x D x H†) (in.)	28 ³ / ₄ x 36 ¹ / ₄ x 78	51 ³ / ₄ x 36 ¹ / ₄ x 78	77 ³ / ₄ x 36 ¹ / ₄ x 78
Int. Dimension (L x D x H) (in.)	23 ⁷ / ₈ x 27 ⁵ / ₈ x 58 ³ / ₄	46 ³ / ₄ x 27 ⁵ / ₈ x 58 ³ / ₄	72 ⁷ / ₈ x 27 ⁵ / ₈ x 58 ³ / ₄
# of Doors	4	8	12
# of Racks Accepted	1	2	3
# of Shelves (Size L x D) (in.)	3 (23 ¹ / ₂ x 26 ³ / ₈)	6 (22 ³ / ₄ x 26 ³ / ₈ (L/R))	9 (22 ³ / ₄ x 26 ³ / ₈ (L/R), 25 x 26 ³ / ₈ (M))
Net Weight (lbs.)	355	531	706
Gross Weight (lbs.)	410	594	777

Design and specifications subject to change without notice. Most updated spec sheets are available at www.turboairinc.com.

Actual shipping weight may differ due to extra packing materials for product protection.

* Depth does not include 2-1/2" for door handles. † Height does not include 5" for caster height.

■ **WARRANTY: 5 Year Parts and Labor Warranty, 7 Year Compressor Warranty**

PASS-THRU GLASS & SOLID HALF DOOR REF. NATURAL Refrigerant

Self-Cleaning Condenser Equipped Units

- Self-Cleaning Condenser (Patented)**
 The accumulation of dust in the condenser can cause the failure or breakdown of refrigerators. Refrigerators run normally until they reach a certain level of accumulation. At some point, when they are over the limit, their performance drops quickly resulting in damage to, or disposal of the stored products inside. The Self-Cleaning Condenser device keeps the condenser clean and prevents system failure by automatically brushing daily.
- Digital temperature control & monitor system**

 - Keeps food products safe by maintaining constant temperatures
 - Alarms that sound when doors are not sealed shut; protects against food spoilage that originates from cold air leaks
 - Early warning alarm program detects issues before malfunction occurs
 - Digital display allows for easy monitoring
 - Programs interpret the condition of refrigeration systems by self-diagnosis
 - Rapid cool-down function (Turbo Cooling)
 - Automatic evaporator fan motor delays
- Hydrocarbon refrigerants (R-290)**
 With innovative and eco-friendly technology, Turbo Air brings you hydrocarbon refrigerators designed to meet DOE's Energy Conservation Standards in 2017 and to use EPA's SNAP Program approved HC refrigerants. Hydrocarbon refrigerants do not deplete the ozone layer and have very low contribution to global warming (ODP-0, GWP-3).
- Cold air distribution system**
 Provides uniformly maintained temperature within the food zone.
- Hot gas condensate system**
 Through Turbo Air's creative innovation, the condensate system surfaces have been specially treated to resist corrosion. This not only increases efficiency without the risk of refrigerant leakage from corrosion, but also prevents the overflow of condensate water.
- All stainless steel cabinet construction**
 The PRO series model boasts a stainless steel interior and a 22 gauge stainless steel exterior (galvanized steel top, bottom). It guarantees the utmost in cleanliness and long product life. The PRO series model adds a touch of style to the most refined setting.
- Sturdy, clean stainless steel shelving**
 Shelves are the most important part of cleanliness as they come in direct contact with food. After a while, PVC coated wire shelves may peel, rust and lead to unsanitary conditions. Only the Turbo Air PRO series uniquely provides stainless steel shelving.
- High-density polyurethane insulation**
 The entire cabinet structure and solid doors are foamed-in-place using high density, CFC free polyurethane insulation.
- LED interior lighting**
- Thermostatic expansion valves**

Self-Cleaning Condenser
 Maintenance-free
 during warranty period



PRO-50R-GSH-PT-N

PRO-26R-GSH-PT-N

- Left hinged (PRO-26R-GSH-PT-N-L), front right hinged & back left hinged (PRO-26R-GSH-PT-N-RL) models available**
- Refrigerator holds 33°F ~ 38°F for the best in food preservation**
- Standard features**

 - Top mount compressor
 - USB temperature data storage
 - Anti-corrosion coated evaporator
 - Easily replaceable one-piece magnetic door gaskets
 - Self-contained system
 - Solid and sturdy grille design
 - Door locks
 - 4" dia. swivel casters with locks on the front set
 - Lead time applies
- Optional features**

 - Legs available for all models
 - Tray slides available

PRO-R-GSH-PT MODELS SPECIFICATIONS

ELECTRICAL DATA	PRO-26R-GSH-PT-N	PRO-50R-GSH-PT-N
Voltage	115/60/1	115/60/1
Plug Type	Ⓢ NEMA 5-15P	Ⓢ NEMA 5-15P
Full Load Amp.	7.0	8.0
Compressor HP	1/2	1/2
Cord Length (ft.)	9	9
Refrigerant	R-290	R-290
DIMENSIONAL DATA		
Net Capacity (cu. ft.)	26.48	53.47
Ext. Dimension (L x D x H†) (in.)	28 ³ / ₄ x 36 ¹ / ₄ x 78	51 ³ / ₄ x 36 ¹ / ₄ x 78
Int. Dimension (L x D x H) (in.)	23 ⁷ / ₈ x 27 ⁵ / ₈ x 58 ³ / ₄	46 ³ / ₄ x 27 ⁵ / ₈ x 58 ³ / ₄
# of Doors	4	8
# of Racks Accepted	1	2
# of Shelves (Size (L x D) (in.))	3 (23 ¹ / ₂ x 26 ³ / ₈)	6 (22 ³ / ₄ x 26 ³ / ₈ (L/R))
Net Weight (lbs.)	383	560
Gross Weight (lbs.)	432	633

Design and specifications subject to change without notice. Most updated spec sheets are available at www.turboairinc.com.

Actual shipping weight may differ due to extra packing materials for product protection.

* Depth does not include 2-1/2" for door handles. † Height does not include 5" for caster height.

WARRANTY: 5 Year Parts and Labor Warranty, 7 Year Compressor Warranty

PASS-THRU GLASS/HALF GLASS DOOR REF. NATURAL Refrigerant

Self-Cleaning Condenser Equipped Units

Self-Cleaning Condenser (Patented)

The accumulation of dust in the condenser can cause the failure or breakdown of refrigerators. Refrigerators run normally until they reach a certain level of accumulation. At some point, when they are over the limit, their performance drops quickly resulting in damage to, or disposal of the stored products inside. The Self-Cleaning Condenser device keeps the condenser clean and prevents system failure by automatically brushing daily.

Digital temperature control & monitor system

- Keeps food products safe by maintaining constant temperatures
- Alarms that sound when doors are not sealed shut; protects against food spoilage that originates from cold air leaks
- Early warning alarm program detects issues before malfunction occurs
- Digital display allows for easy monitoring
- Programs interpret the condition of refrigeration systems by self-diagnosis
- Rapid cool-down function (Turbo Cooling)
- Automatic evaporator fan motor delays

Hydrocarbon refrigerants (R-290)

With innovative and eco-friendly technology, Turbo Air brings you hydrocarbon refrigerators designed to meet DOE's Energy Conservation Standards in 2017 and to use EPA's SNAP Program approved HC refrigerants. Hydrocarbon refrigerants do not deplete the ozone layer and have very low contribution to global warming (ODP-0, GWP-3).

Cold air distribution system

Provides uniformly maintained temperature within the food zone.

Hot gas condensate system

Through Turbo Air's creative innovation, the condensate system surfaces have been specially treated to resist corrosion. This not only increases efficiency without the risk of refrigerant leakage from corrosion, but also prevents the overflow of condensate water.

All stainless steel cabinet construction

The PRO series model boasts a stainless steel interior and a 22 gauge stainless steel exterior (galvanized steel top, bottom). It guarantees the utmost in cleanliness and long product life. The PRO series model adds a touch of style to the most refined setting.

Sturdy, clean stainless steel shelving

Shelves are the most important part of cleanliness as they come in direct contact with food. After a while, PVC coated wire shelves may peel, rust and lead to unsanitary conditions. Only the Turbo Air PRO series uniquely provides stainless steel shelving.

LED interior lighting

Thermostatic expansion valves

High-density polyurethane insulation

The entire cabinet structure and solid doors are foamed-in-place using high density, CFC free polyurethane insulation.

Self-Cleaning Condenser
Maintenance-free
during warranty period



PRO-26R-G-PT-N



PRO-50-4R-G-PT-N

■ **Left hinged (PRO-26R-G-PT-N-L, PRO-26-2R-G-PT-N-L), front left hinged & back right hinged (PRO-26-2R-G-PT-LR), front right hinged & back left hinged (PRO-26-2R-G-PT-RL) models available**

■ **Refrigerator holds 33°F ~ 38°F for the best in food preservation**

Standard features

- Top mount compressor
- USB temperature data storage
- Anti-corrosion coated evaporator
- Easily replaceable one-piece magnetic door gaskets
- Self-contained system
- Solid and sturdy grille design
- Door locks
- 4" dia. swivel casters with locks on the front set
- Lead time applies

Optional features

- Legs available for all models
- Tray slides available

PRO-R-G-PT MODELS SPECIFICATIONS

ELECTRICAL DATA	PRO-26R-G-PT-N	PRO-50R-G-PT-N	PRO-26-2R-G-PT-N	PRO-50-4R-G-PT-N
Voltage	115/60/1	115/60/1	115/60/1	115/60/1
Plug Type	Ⓢ NEMA 5-15P	Ⓢ NEMA 5-15P	Ⓢ NEMA 5-15P	Ⓢ NEMA 5-15P
Full Load Amp.	7.0	8.0	7.0	8.0
Compressor HP	1/2	1/2	1/2	1/2
Cord Length (ft.)	9	9	9	9
Refrigerant	R-290	R-290	R-290	R-290
DIMENSIONAL DATA				
Net Capacity (cu. ft.)	29.01	54.82	27.52	50.23
Ext. Dimension (L x D x H†) (in.)	28 ³ / ₄ x 36 ¹ / ₄ x 78	51 ³ / ₄ x 36 ¹ / ₄ x 78	28 ³ / ₄ x 36 ¹ / ₄ x 78	51 ³ / ₄ x 36 ¹ / ₄ x 78
Int. Dimension (L x D x H) (in.)	23 ⁷ / ₈ x 27 ⁵ / ₈ x 58 ³ / ₄	46 ³ / ₄ x 27 ⁵ / ₈ x 58 ³ / ₄	23 ⁷ / ₈ x 27 ⁵ / ₈ x 58 ³ / ₄	46 ³ / ₄ x 27 ⁵ / ₈ x 58 ³ / ₄
# of Doors	2	4	4	8
# of Racks Accepted	1	2	1	2
# of Shelves (Size (L x D) (in.))	3 (23 ¹ / ₂ x 26 ³ / ₈)	6 (22 ³ / ₄ x 26 ³ / ₈ (L/R))	3 (23 ¹ / ₂ x 26 ³ / ₈)	6 (22 ³ / ₄ x 26 ³ / ₈ (L/R))
Net Weight (lbs.)	379	583	407	611
Gross Weight (lbs.)	422	646	450	674

Design and specifications subject to change without notice. Most updated spec sheets are available at www.turboairinc.com.

Actual shipping weight may differ due to extra packing materials for product protection.

* Depth does not include 2-1/2" for door handles. † Height does not include 5" for caster height.

■ **WARRANTY: 5 Year Parts and Labor Warranty, 7 Year Compressor Warranty**

PASS-THRU GLASS & SOLID DOOR REF. NATURAL Refrigerant

Self-Cleaning Condenser Equipped Units

■ **Self-Cleaning Condenser (Patented)**

The accumulation of dust in the condenser can cause the failure or breakdown of refrigerators. Refrigerators run normally until they reach a certain level of accumulation. At some point, when they are over the limit, their performance drops quickly resulting in damage to, or disposal of the stored products inside. The Self-Cleaning Condenser device keeps the condenser clean and prevents system failure by automatically brushing daily.

■ **Digital temperature control & monitor system**

- Keeps food products safe by maintaining constant temperatures
- Alarms that sound when doors are not sealed shut; protects against food spoilage that originates from cold air leaks
- Early warning alarm program detects issues before malfunction occurs
- Digital display allows for easy monitoring
- Programs interpret the condition of refrigeration systems by self-diagnosis
- Rapid cool-down function (Turbo Cooling)
- Automatic evaporator fan motor delays

■ **Hydrocarbon refrigerants (R-290)**

With innovative and eco-friendly technology, Turbo Air brings you hydrocarbon refrigerators designed to meet DOE's Energy Conservation Standards in 2017 and to use EPA's SNAP Program approved HC refrigerants. Hydrocarbon refrigerants do not deplete the ozone layer and have very low contribution to global warming (ODP-0, GWP-3).

■ **Cold air distribution system**

Provides uniformly maintained temperature within the food zone.

■ **Hot gas condensate system**

Through Turbo Air's creative innovation, the condensate system surfaces have been specially treated to resist corrosion. This not only increases efficiency without the risk of refrigerant leakage from corrosion, but also prevents the overflow of condensate water.

■ **All stainless steel cabinet construction**

The PRO series model boasts a stainless steel interior and a 22 gauge stainless steel exterior (galvanized steel top, bottom). It guarantees the utmost in cleanliness and long product life. The PRO series model adds a touch of style to the most refined setting.

■ **Sturdy, clean stainless steel shelving**

Shelves are the most important part of cleanliness as they come in direct contact with food. After a while, PVC coated wire shelves may peel, rust and lead to unsanitary conditions. Only the Turbo Air PRO series uniquely provides stainless steel shelving.

■ **LED interior lighting**

■ **Thermostatic expansion valves**

■ **High-density polyurethane insulation**

The entire cabinet structure and solid doors are foamed-in-place using high density, CFC free polyurethane insulation.

Self-Cleaning Condenser
Maintenance-free
during warranty period



PRO-26R-SG-PT-N

PRO-50-4R-GS-PT-N

■ **Left hinged (PRO-26R-GS-PT-N-L, PRO-26R-SG-PT-N-L, PRO-26-2R-GS-PT-N-L, PRO-26-2R-SG-PT-N-L), front right hinged & back left hinged (PRO-26-2R-GS-PT-N-RL) models available**

■ **Refrigerator holds 33°F ~ 38°F for the best in food preservation**

■ **Standard features**

- Top mount compressor
- USB temperature data storage
- Anti-corrosion coated evaporator
- Easily replaceable one-piece magnetic door gaskets
- Self-contained system
- Solid and sturdy grille design
- Door locks
- 4" dia. swivel casters with locks on the front set
- Lead time applies

■ **Optional features**

- Legs available for all models
- Tray slides available

PRO-R-GS(SG)-PT MODELS SPECIFICATIONS

ELECTRICAL DATA	PRO-26R-GS(SG)-PT-N	PRO-50R-GS-PT-N	PRO-26-2R-GS(SG)-PT-N	PRO-50-4R-GS-PT-N
Voltage	115/60/1	115/60/1	115/60/1	115/60/1
Plug Type	Ⓜ NEMA 5-15P	Ⓜ NEMA 5-15P	Ⓜ NEMA 5-15P	Ⓜ NEMA 5-15P
Full Load Amp.	7.0	8.0	7.0	8.0
Compressor HP	1/2	1/2	1/2	1/2
Cord Length (ft.)	9	9	9	9
Refrigerant	R-290	R-290	R-290	R-290
DIMENSIONAL DATA				
Net Capacity (cu. ft.)	26.48	53.87	26.48	53.47
Ext. Dimension (L x D x H†) (in.)	28 ³ / ₄ x 36 ¹ / ₄ x 78	51 ³ / ₄ x 36 ¹ / ₄ x 78	28 ³ / ₄ x 36 ¹ / ₄ x 78	51 ³ / ₄ x 36 ¹ / ₄ x 78
Int. Dimension (L x D x H) (in.)	23 ⁷ / ₈ x 27 ⁵ / ₈ x 58 ³ / ₄	46 ³ / ₄ x 27 ⁵ / ₈ x 58 ³ / ₄	23 ⁷ / ₈ x 27 ⁵ / ₈ x 58 ³ / ₄	46 ³ / ₄ x 27 ⁵ / ₈ x 58 ³ / ₄
# of Doors	2	4	4	8
# of Racks Accepted	1	2	1	2
# of Shelves (Size (L x D) (in.))	3 (23 ¹ / ₂ x 26 ³ / ₈)	6 (22 ³ / ₄ x 26 ³ / ₈ (L/R))	3 (23 ¹ / ₂ x 26 ³ / ₈)	6 (22 ³ / ₄ x 26 ³ / ₈ (L/R))
Net Weight (lbs.)	360	565	360	565
Gross Weight (lbs.)	416	633	416	633

Design and specifications subject to change without notice. Most updated spec sheets are available at www.turboairinc.com.

Actual shipping weight may differ due to extra packing materials for product protection.

* Depth does not include 2-1/2" for door handles. † Height does not include 5" for caster height.

■ **WARRANTY: 5 Year Parts and Labor Warranty, 7 Year Compressor Warranty**

ROLL-IN SOLID DOOR REFRIGERATORS NATURAL Refrigerant

Self-Cleaning Condenser Equipped Units

■ **Self-Cleaning Condenser (Patented)**

The accumulation of dust in the condenser can cause the failure or breakdown of refrigerators. Refrigerators run normally until they reach a certain level of accumulation. At some point, when they are over the limit, their performance drops quickly resulting in damage to, or disposal of the stored products inside. The Self-Cleaning Condenser device keeps the condenser clean and prevents system failure by automatically brushing daily.

■ **Digital temperature control & monitor system**

- Keeps food products safe by maintaining constant temperatures
- Alarms that sound when doors are not sealed shut; protects against food spoilage that originates from cold air leaks
- Early warning alarm program detects issues before malfunction occurs
- Digital display allows for easy monitoring
- Programs interpret the condition of refrigeration systems by self-diagnosis
- Rapid cool-down function (Turbo Cooling)
- Automatic evaporator fan motor delays

■ **Hydrocarbon refrigerants (R-290)**

With innovative and eco-friendly technology, Turbo Air brings you hydrocarbon refrigerators designed to meet DOE's Energy Conservation Standards in 2017 and to use EPA's SNAP Program approved HC refrigerants. Hydrocarbon refrigerants do not deplete the ozone layer and have very low contribution to global warming (ODP-0, GWP-3).

■ **Cold air distribution system**

Provides uniformly maintained temperature within the food zone.

■ **Hot gas condensate system**

Through Turbo Air's creative innovation, the condensate system surfaces have been specially treated to resist corrosion. This not only increases efficiency without the risk of refrigerant leakage from corrosion, but also prevents the overflow of condensate water.

■ **All stainless steel cabinet construction**

The PRO series model boasts a stainless steel interior and a 22 gauge stainless steel exterior (galvanized steel top, bottom). It guarantees the utmost in cleanliness and long product life. The PRO series model adds a touch of style to the most refined setting.

■ **LED interior lighting**

■ **High-density polyurethane insulation**

The entire cabinet structure and solid doors are foamed-in-place using high density, CFC free polyurethane insulation.

■ **Left hinged model available (PRO-26R-RI-N-L)**

■ **Thermostatic expansion valves**

Self-Cleaning Condenser
Maintenance-free
during warranty period



PRO-50R-RI-N

PRO-26R-RI-N

■ **Refrigerator holds 33°F ~ 38°F for the best in food preservation**

■ **Standard features**

- Top mount compressor
- USB temperature data storage
- Anti-corrosion coated evaporator
- Door locks
- Self-contained system
- Solid and sturdy grille design
- Heavy duty stainless steel ramp

PRO-R-RI MODELS SPECIFICATIONS

ELECTRICAL DATA	PRO-26R-RI-N	PRO-50R-RI-N
Voltage	115/60/1	115/60/1
Plug Type	Ⓢ NEMA 5-15P	Ⓢ NEMA 5-15P
Full Load Amp.	7.0	8.0
Compressor HP	1/2	1
Cord Length (ft.)	9	9
Refrigerant	R-290	R-290
DIMENSIONAL DATA		
Net Capacity (cu. ft.)	39.32	81.87
Ext. Dimension (L x D' x H) (in.)	34 x 37 ³ / ₄ x 84 ¹ / ₄	66 ⁷ / ₈ x 37 ³ / ₄ x 84 ¹ / ₄
Int. Dimension (L x D x H) (in.)	29 ¹ / ₈ x 31 ¹ / ₂ x 66 ⁷ / ₈	62 x 31 ¹ / ₂ x 66 ⁷ / ₈
# of Doors	1	2
# of Racks Accepted	1	2
# of Shelves	-	-
Net Weight (lbs.)	392	726
Gross Weight (lbs.)	492	820

Design and specifications subject to change without notice. Most updated spec sheets are available at www.turboairinc.com.

Actual shipping weight may differ due to extra packing materials for product protection.

* Depth does not include 1-1/4" for door handles and 3-1/2" for ramps.

■ **WARRANTY: 5 Year Parts and Labor Warranty, 7 Year Compressor Warranty**

ROLL-IN GLASS DOOR REFRIGERATORS NATURAL Refrigerant

Self-Cleaning Condenser Equipped Units

■ **Self-Cleaning Condenser (Patented)**

The accumulation of dust in the condenser can cause the failure or breakdown of refrigerators. Refrigerators run normally until they reach a certain level of accumulation. At some point, when they are over the limit, their performance drops quickly resulting in damage to, or disposal of the stored products inside. The Self-Cleaning Condenser device keeps the condenser clean and prevents system failure by automatically brushing daily.

■ **Digital temperature control & monitor system**

- Keeps food products safe by maintaining constant temperatures
- Alarms that sound when doors are not sealed shut; protects against food spoilage that originates from cold air leaks
- Early warning alarm program detects issues before malfunction occurs
- Digital display allows for easy monitoring
- Programs interpret the condition of refrigeration systems by self-diagnosis
- Rapid cool-down function (Turbo Cooling)
- Automatic evaporator fan motor delays

■ **Hydrocarbon refrigerants (R-290)**

With innovative and eco-friendly technology, Turbo Air brings you hydrocarbon refrigerators designed to meet DOE's Energy Conservation Standards in 2017 and to use EPA's SNAP Program approved HC refrigerants. Hydrocarbon refrigerants do not deplete the ozone layer and have very low contribution to global warming (ODP-0, GWP-3).

■ **Cold air distribution system**

Provides uniformly maintained temperature within the food zone.

■ **Hot gas condensate system**

Through Turbo Air's creative innovation, the condensate system surfaces have been specially treated to resist corrosion. This not only increases efficiency without the risk of refrigerant leakage from corrosion, but also prevents the overflow of condensate water.

■ **All stainless steel cabinet construction**

The PRO series model boasts a stainless steel interior and a **22 gauge** stainless steel exterior (galvanized steel top, bottom). It guarantees the utmost in cleanliness and long product life. The PRO series model adds a touch of style to the most refined setting.

■ **LED interior lighting**

■ **High-density polyurethane insulation**

The entire cabinet structure and solid doors are foamed-in-place using high density, CFC free polyurethane insulation.

■ **Thermostatic expansion valves**

■ **Left hinged model available (PRO-26R-G-RI-N-L)**



Self-Cleaning Condenser
Maintenance-free during warranty period

PRO-26R-G-RI-N

PRO-50R-G-RI-N

■ **Refrigerator holds 33°F ~ 38°F for the best in food preservation**

■ **Standard features**

- Top mount compressor
- USB temperature data storage
- Anti-corrosion coated evaporator
- Door locks
- Self-contained system
- Solid and sturdy grille design
- Heavy duty stainless steel ramp
- Lead time applies

PRO-R-G-RI MODELS SPECIFICATIONS

ELECTRICAL DATA	PRO-26R-G-RI-N	PRO-50R-G-RI-N
Voltage	115/60/1	115/60/1
Plug Type	Ⓢ NEMA 5-15P	Ⓢ NEMA 5-15P
Full Load Amp.	7.0	8.0
Compressor HP	1/2	1
Cord Length (ft.)	9	9
Refrigerant	R-290	R-290
DIMENSIONAL DATA		
Net Capacity (cu. ft.)	39.68	82.01
Ext. Dimension (L x D x H) (in.)	34 x 37 ³ / ₄ x 84 ¹ / ₄	66 ⁷ / ₈ x 37 ³ / ₄ x 84 ¹ / ₄
Int. Dimension (L x D x H) (in.)	29 ¹ / ₈ x 31 ¹ / ₂ x 66 ⁷ / ₈	62 x 31 ¹ / ₂ x 66 ⁷ / ₈
# of Doors	1	2
# of Racks Accepted	1	2
# of Shelves	-	-
Net Weight (lbs.)	420	756
Gross Weight (lbs.)	496	865

Design and specifications subject to change without notice. Most updated spec sheets are available at www.turboairinc.com.

Actual shipping weight may differ due to extra packing materials for product protection.

* Depth does not include 1-3/8" for door handles and 3-1/2" for ramps.

■ **WARRANTY: 5 Year Parts and Labor Warranty, 7 Year Compressor Warranty**

ROLL-IN SOLID DOOR FREEZERS **NATURAL Refrigerant**

Self-Cleaning Condenser Equipped Units

Self-Cleaning Condenser (Patented)

The accumulation of dust in the condenser can cause the failure or breakdown of refrigerators. Refrigerators run normally until they reach a certain level of accumulation. At some point, when they are over the limit, their performance drops quickly resulting in damage to, or disposal of the stored products inside. The Self-Cleaning Condenser device keeps the condenser clean and prevents system failure by automatically brushing daily.

Digital temperature control & monitor system

- Keeps food products safe by maintaining constant temperatures
- Alarms that sound when doors are not sealed shut; protects against food spoilage that originates from cold air leaks
- Early warning alarm program detects issues before malfunction occurs
- Digital display allows for easy monitoring
- Programs interpret the condition of refrigeration systems by self-diagnosis
- Rapid cool-down function (Turbo Freeze)
- Automatic evaporator fan motor delays

Hydrocarbon refrigerants (R-290)

With innovative and eco-friendly technology, Turbo Air brings you hydrocarbon refrigerators designed to meet DOE's Energy Conservation Standards in 2017 and to use EPA's SNAP Program approved HC refrigerants. Hydrocarbon refrigerants do not deplete the ozone layer and have very low contribution to global warming (ODP-0, GWP-3).

Cold air distribution system

Provides uniformly maintained temperature within the food zone.

Hot gas condensate system

Through Turbo Air's creative innovation, the condensate system surfaces have been specially treated to resist corrosion. This not only increases efficiency without the risk of refrigerant leakage from corrosion, but also prevents the overflow of condensate water.

All stainless steel cabinet construction

The PRO series model boasts a stainless steel interior and a 22 gauge stainless steel exterior (galvanized steel top, bottom). It guarantees the utmost in cleanliness and long product life. The PRO series model adds a touch of style to the most refined setting.

LED interior lighting

High-density polyurethane insulation

The entire cabinet structure and solid doors are foamed-in-place using high density, CFC free polyurethane insulation.

Thermostatic expansion valves

Self-Cleaning Condenser
Maintenance-free
during warranty period



PRO-50F-RI-N

PRO-26F-RI-N

Left hinged model available (PRO-26F-RI-N-L)

Freezer holds -10°F ~ 0°F for the best in frozen food preservation

Standard features

- Top mount compressor
- Anti-corrosion coated evaporator
- Door locks
- Self-contained system
- Solid and sturdy grille design
- Heavy duty stainless steel ramp
- USB temperature data storage for PRO-26F-RI-N only

PRO-F-RI MODELS SPECIFICATIONS

ELECTRICAL DATA	PRO-26F-RI-N	PRO-50F-RI-N
Voltage	115/60/1	115/60/1
Plug Type	Ⓢ NEMA 5-15P	Ⓢ NEMA 5-20P
Full Load Amp.	7.0	16.0
Compressor HP	1/2	1/2 x 2
Cord Length (ft.)	9	9
Refrigerant	R-290	R-290
DIMENSIONAL DATA		
Net Capacity (cu. ft.)	39.99	81.7
Ext. Dimension (L x D x H) (in.)	34 x 37 3/4 x 84 1/4	66 7/8 x 37 3/4 x 84 1/4
Int. Dimension (L x D x H) (in.)	29 1/8 x 31 1/2 x 66 7/8	62 x 31 1/2 x 66 7/8
# of Doors	1	2
# of Racks Accepted	1	2
# of Shelves	-	-
Net Weight (lbs.)	415	726
Gross Weight (lbs.)	508	862

Design and specifications subject to change without notice. Most updated spec sheets are available at www.turboairinc.com.

Actual shipping weight may differ due to extra packing materials for product protection.

* Depth does not include 1-1/4" for door handles and 3-1/2" for ramps.

WARRANTY: 5 Year Parts and Labor Warranty, 7 Year Compressor Warranty

FULL/HALF SOLID DOOR HEATED CABINETS

- **Digital temperature control & monitor system**
 - Keeps food products safe by maintaining constant temperatures
 - Alarm beeps when doors are not sealed
 - Early warning alarm program detects issues before malfunction occurs
 - Digital display allows for easy monitoring
 - Sensitive touch display
- **Ducted fan air distribution system**
Maintains temperature within the food zone.
- **On/Off switch**
ON/OFF switch is located on control panel
- **All stainless steel cabinet construction**
The PRO series model boasts a stainless steel interior and a **22 gauge** stainless steel exterior (galvanized steel top, bottom). It guarantees the utmost in cleanliness and long product life. The PRO series model adds a touch of style to the most refined setting.
- **Sturdy, clean stainless steel shelving**
Only the Turbo Air PRO series uniquely provides stainless steel shelving. Shelves are the most important part of cleanliness as they come in direct contact with food. After a while, PVC coated wire shelves may peel, rust and lead to unsanitary conditions.
- **LED interior lighting**
- **High-density polyurethane insulation**
Structure and solid doors are foamed-in-place using high density, CFC free polyurethane insulation.
- **Full or half length stainless steel doors with locks**
- **Self-closing doors with stay open feature at 120 degrees**
- **Left hinged models available (PRO-15H-L, PRO-15-2H-L)**
- **Heated cabinet holds 140°F ~ 180°F for the best in food preservation**



PRO-15H

PRO-15-2H

- **Standard features**
 - Door locks
 - 4" dia. swivel casters with locks on the front set
 - Easy replaceable one piece magnetic door gaskets
 - Solid and sturdy grille design
 - Lead time applies
- **Optional features**
 - Legs available for all models

PRO-H MODELS SPECIFICATIONS

ELECTRICAL DATA	PRO-15H	PRO-15-2H
Voltage	115/60/1	115/60/1
Plug Type	Ⓢ NEMA 5-15P	Ⓢ NEMA 5-15P
Full Load Amp.	8.5	8.5
Wattage (W)	950	950
Cord Length (ft.)	8	8
DIMENSIONAL DATA		
Net Capacity (cu. ft.)	14.0	13.8
Ext. Dimension (L x D x H†) (in.)	17 ³ / ₄ x 34 ³ / ₈ x 78	17 ³ / ₄ x 34 ³ / ₈ x 78
Int. Dimension (L x D x H) (in.)	13 ³ / ₄ x 25 ³ / ₈ x 58 ³ / ₄	13 ³ / ₄ x 25 ³ / ₈ x 58 ³ / ₄
# of Doors	1	2
# of Racks Accepted	-	-
# of Shelves (Size (L x D) (in.))	3 (12 ¹ / ₂ x 25 ¹ / ₈)	3 (12 ¹ / ₂ x 25 ¹ / ₈)
Net Weight (lbs.)	224	230
Gross Weight (lbs.)	254	260

Design and specifications subject to change without notice. Most updated spec sheets are available at www.turboairinc.com.

Actual shipping weight may differ due to extra packing materials for product protection.

* Depth does not include 1-3/8" for door handles. † Height does not include 5" for caster height.

- **WARRANTY: 3 Year Parts and Labor Warranty**

SOLID DOOR HEATED CABINETS

■ **Digital temperature control & monitor system**

- Keeps food products safe by maintaining constant temperatures
- Alarm beeps when doors are not sealed
- Early warning alarm program detects issues before malfunction occurs
- Digital display allows for easy monitoring
- Sensitive touch display

■ **Ducted fan air distribution system**

Maintains temperature within the food zone.

■ **On/Off switch**

ON/OFF switch is located on control panel

■ **All stainless steel cabinet construction**

The PRO series model boasts a stainless steel interior and a **22 gauge** stainless steel exterior (galvanized steel top, bottom). It guarantees the utmost in cleanliness and long product life. The PRO series model adds a touch of style to the most refined setting.

■ **Sturdy, clean stainless steel shelving**

Only the Turbo Air PRO series uniquely provides stainless steel shelving. Shelves are the most important part of cleanliness as they come in direct contact with food. After a while, PVC coated wire shelves may peel, rust and lead to unsanitary conditions.

■ **LED interior lighting**

■ **High-density polyurethane insulation**

Structure and solid doors are foamed-in-place using high density, CFC free polyurethane insulation.

■ **Full length stainless steel doors with locks**

■ **Self-closing doors with stay open feature at 120 degrees**

■ **Left hinged models available (PRO-26H-L, PRO-26H2-L)**

■ **Heated cabinet holds 140°F ~ 180°F for the best in food preservation**

■ **Standard features**

- Door locks
- 4" dia. swivel casters with locks on the front set
- Easy replaceable one piece magnetic door gaskets
- Solid and sturdy grille design
- Lead time applies



PRO-26H

PRO-50H

■ **Optional features**

- Legs available for all models
- Tray slides available

PRO-H MODELS SPECIFICATIONS

ELECTRICAL DATA	PRO-26H	PRO-26H2	PRO-50H	PRO-77H
Voltage	115/60/1	208/115/60/1	208/115/60/1	208/115/60/1
Plug Type	Ⓜ NEMA 5-15P	Ⓜ NEMA L14-20P	Ⓜ NEMA L14-20P	Ⓜ NEMA L14-20P
Full Load Amp.	13.5	7.5	15	15
Wattage (W)	1550	1550	3000	3000
Cord Length (ft.)	8	8	8	8
DIMENSIONAL DATA				
Net Capacity (cu. ft.)	25.0	25.0	48.0	73.0
Ext. Dimension (L x D [*] x H [†]) (in.)	28 ³ / ₄ x 33 ⁷ / ₈ x 78	28 ³ / ₄ x 33 ⁷ / ₈ x 78	51 ³ / ₄ x 33 ⁷ / ₈ x 78	77 ³ / ₄ x 33 ⁷ / ₈ x 78
Int. Dimension (L x D x H) (in.)	22 x 27 ⁵ / ₈ x 58 ³ / ₄	22 x 27 ⁵ / ₈ x 58 ³ / ₄	42 ¹ / ₄ x 27 ⁵ / ₈ x 58 ³ / ₄	68 ¹ / ₄ x 27 ⁵ / ₈ x 58 ³ / ₄
# of Doors	1	1	2	3
# of Racks Accepted	1	1	2	3
# of Shelves (Size (L x D) (in.))	3 (23 ¹ / ₂ x 26 ³ / ₈)	3 (23 ¹ / ₂ x 26 ³ / ₈)	6 (22 ³ / ₄ x 26 ³ / ₈)	9 (22 ³ / ₄ x 26 ³ / ₈ (L/R), 25 x 26 ³ / ₈ (M))
Net Weight (lbs.)	259	259	404	700
Gross Weight (lbs.)	304	304	462	768

Design and specifications subject to change without notice. Most updated spec sheets are available at www.turboairinc.com.

Actual shipping weight may differ due to extra packing materials for product protection.

* Depth does not include 1-1/4" for door handles. † Height does not include 5" for caster height.

■ **WARRANTY: 3 Year Parts and Labor Warranty**

HALF SOLID DOOR HEATED CABINETS

- **Digital temperature control & monitor system**
 - Keeps food products safe by maintaining constant temperatures
 - Alarm beeps when doors are not sealed
 - Early warning alarm program detects issues before malfunction occurs
 - Digital display allows for easy monitoring
 - Sensitive touch display
- **Ducted fan air distribution system**
Maintains temperature within the food zone.
- **On/Off switch**
ON/OFF switch is located on control panel
- **All stainless steel cabinet construction**
The PRO series model boasts a stainless steel interior and a **22 gauge** stainless steel exterior (galvanized steel top, bottom). It guarantees the utmost in cleanliness and long product life. The PRO series model adds a touch of style to the most refined setting.
- **Sturdy, clean stainless steel shelving**
Only the Turbo Air PRO series uniquely provides stainless steel shelving. Shelves are the most important part of cleanliness as they come in direct contact with food. After a while, PVC coated wire shelves may peel, rust and lead to unsanitary conditions.
- **LED interior lighting**
- **High-density polyurethane insulation**
Structure and solid doors are foamed-in-place using high density, CFC free polyurethane insulation.
- **Half length stainless steel doors with locks**
- **Self-closing doors with stay open feature at 120 degrees**
- **Left hinged models available**
(PRO-26-2H-L, PRO-26-2H2-L)
- **Heated cabinet holds 140°F ~ 180°F for the best in food preservation**



- **Standard features**
 - Door locks
 - 4" dia. swivel casters with locks on the front set
 - Easy replaceable one piece magnetic door gaskets
 - Solid and sturdy grille design
 - Lead time applies
- **Optional features**
 - Legs available for all models
 - Tray slides available

PRO-H MODELS SPECIFICATIONS

ELECTRICAL DATA	PRO-26-2H	PRO-26-2H2	PRO-50-4H	PRO-77-6H
Voltage	115/60/1	208/115/60/1	208/115/60/1	208/115/60/1
Plug Type	Ⓜ NEMA 5-15P	Ⓜ NEMA L14-20P	Ⓜ NEMA L14-20P	Ⓜ NEMA L14-20P
Full Load Amp.	13.5	7.5	15	15
Wattage (W)	1550	1550	3000	3000
Cord Length (ft.)	8	8	8	8
DIMENSIONAL DATA				
Net Capacity (cu. ft.)	25.0	25.0	47.0	73.0
Ext. Dimension (L x D x HT) (in.)	28 ³ / ₄ x 33 ⁷ / ₈ x 78	28 ³ / ₄ x 33 ⁷ / ₈ x 78	51 ³ / ₄ x 33 ⁷ / ₈ x 78	77 ³ / ₄ x 33 ⁷ / ₈ x 78
Int. Dimension (L x D x H) (in.)	22 x 27 ⁵ / ₈ x 58 ³ / ₄	22 x 27 ⁵ / ₈ x 58 ³ / ₄	42 ¹ / ₄ x 27 ⁵ / ₈ x 58 ³ / ₄	68 ¹ / ₄ x 27 ⁵ / ₈ x 58 ³ / ₄
# of Doors	2	2	4	6
# of Racks Accepted	1	1	2	3
# of Shelves (Size (L x D) (in.))	3 (23 ¹ / ₂ x 26 ³ / ₈)	3 (23 ¹ / ₂ x 26 ³ / ₈)	6 (22 ³ / ₄ x 26 ³ / ₈ (L/R))	9 (22 ³ / ₄ x 26 ³ / ₈ (L/R), 25 x 26 ³ / ₈ (M))
Net Weight (lbs.)	265	265	422	718
Gross Weight (lbs.)	310	310	480	786

Design and specifications subject to change without notice. Most updated spec sheets are available at www.turboairinc.com.

Actual shipping weight may differ due to extra packing materials for product protection.

* Depth does not include 1-1/4" for door handles. † Height does not include 5" for caster height.

■ **WARRANTY: 3 Year Parts and Labor Warranty**

FULL/HALF GLASS DOOR HEATED CABINETS

■ **Digital temperature control & monitor system**

- Keeps food products safe by maintaining constant temperatures
- Alarm beeps when doors are not sealed
- Early warning alarm program detects issues before malfunction occurs
- Digital display allows for easy monitoring
- Sensitive touch display

■ **Ducted fan air distribution system**

Maintains temperature within the food zone.

■ **On/Off switch**

ON/OFF switch is located on control panel

■ **All stainless steel cabinet construction**

The PRO series model boasts a stainless steel interior and a 22 gauge stainless steel exterior (galvanized steel top, bottom). It guarantees the utmost in cleanliness and long product life. The PRO series model adds a touch of style to the most refined setting.

■ **Sturdy, clean stainless steel shelving**

Only the Turbo Air PRO series uniquely provides stainless steel shelving. Shelves are the most important part of cleanliness as they come in direct contact with food. After a while, PVC coated wire shelves may peel, rust and lead to unsanitary conditions.

■ **LED interior lighting**

■ **High-density polyurethane insulation**

Structure and solid doors are foamed-in-place using high density, CFC free polyurethane insulation.

■ **Full or half length glass doors with locks**

■ **Self-closing doors with stay open feature at 120 degrees**

■ **Heated cabinet holds 140°F ~ 180°F for the best in food preservation**



PRO-15H-G

PRO-15-2H-G

■ **Standard features**

- Door locks
- 4" dia. swivel casters with locks on the front set
- Easy replaceable one piece magnetic door gaskets
- Solid and sturdy grille design
- Lead time applies

■ **Optional features**

- Legs available for all models

PRO-H-G MODELS SPECIFICATIONS

ELECTRICAL DATA	PRO-15H-G	PRO-15-2H-G
Voltage	115/60/1	115/60/1
Plug Type	Ⓢ NEMA 5-15P	Ⓢ NEMA 5-15P
Full Load Amp.	8.5	8.5
Wattage (W)	950	950
Cord Length (ft.)	8	8
DIMENSIONAL DATA		
Net Capacity (cu. ft.)	14.0	13.8
Ext. Dimension (L x D [*] x H [†]) (in.)	17 ³ / ₄ x 34 ³ / ₈ x 78	17 ³ / ₄ x 34 ³ / ₈ x 78
Int. Dimension (L x D x H) (in.)	13 ³ / ₄ x 25 ³ / ₈ x 58 ³ / ₄	13 ³ / ₄ x 25 ³ / ₈ x 58 ³ / ₄
# of Doors	1	2
# of Racks Accepted	-	-
# of Shelves (Size (L x D) (in.))	3 (12 ¹ / ₂ x 25 ¹ / ₈)	3 (12 ¹ / ₂ x 25 ¹ / ₈)
Net Weight (lbs.)	235	240
Gross Weight (lbs.)	265	270

Design and specifications subject to change without notice. Most updated spec sheets are available at www.turboairinc.com.

Actual shipping weight may differ due to extra packing materials for product protection.

* Depth does not include 1-1/4" for door handles. † Height does not include 5" for caster height.

■ **WARRANTY: 3 Year Parts and Labor Warranty**

GLASS DOOR HEATED CABINETS

■ **Digital temperature control & monitor system**

- Keeps food products safe by maintaining constant temperatures
- Alarm beeps when doors are not sealed
- Early warning alarm program detects issues before malfunction occurs
- Digital display allows for easy monitoring
- Sensitive touch display

■ **Ducted fan air distribution system**

Maintains temperature within the food zone.

■ **On/Off switch**

ON/OFF switch is located on control panel

■ **All stainless steel cabinet construction**

The PRO series model boasts a stainless steel interior and a **22 gauge** stainless steel exterior (galvanized steel top, bottom). It guarantees the utmost in cleanliness and long product life. The PRO series model adds a touch of style to the most refined setting.

■ **Sturdy, clean stainless steel shelving**

Only the Turbo Air PRO series uniquely provides stainless steel shelving. Shelves are the most important part of cleanliness as they come in direct contact with food. After a while, PVC coated wire shelves may peel, rust and lead to unsanitary conditions.

■ **LED interior lighting**

■ **High-density polyurethane insulation**

Structure and solid doors are foamed-in-place using high density, CFC free polyurethane insulation.

■ **Full length glass doors with locks**

■ **Self-closing doors with stay open feature at 120 degrees**

■ **Left hinged models available**
(PRO-26H-G-L, PRO-26H2-G-L)

■ **Heated cabinet holds 140°F ~ 180°F for the best in food preservation**



PRO-77H-G

PRO-50H-G

■ **Standard features**

- Door locks
- 4" dia. swivel casters with locks on the front set
- Easy replaceable one piece magnetic door gaskets
- Solid and sturdy grille design
- Lead time applies

■ **Optional features**

- Legs available for all models
- Tray slides available

PRO-H-G MODELS SPECIFICATIONS

ELECTRICAL DATA	PRO-26H-G	PRO-26H2-G	PRO-50H-G	PRO-77H-G
Voltage	115/60/1	208/115/60/1	208/115/60/1	208/115/60/1
Plug Type	Ⓜ NEMA 5-15P	Ⓜ NEMA L14-20P	Ⓜ NEMA L14-20P	Ⓜ NEMA L14-20P
Full Load Amp.	13.5	7.5	15	15
Wattage (W)	1550	1550	3000	3000
Cord Length (ft.)	8	8	8	8
DIMENSIONAL DATA				
Net Capacity (cu. ft.)	26.0	26.0	49.0	75.0
Ext. Dimension (L x D x H†) (in.)	28 ³ / ₄ x 33 ⁷ / ₈ x 78	28 ³ / ₄ x 33 ⁷ / ₈ x 78	51 ³ / ₄ x 33 ⁷ / ₈ x 78	77 ³ / ₄ x 33 ⁷ / ₈ x 78
Int. Dimension (L x D x H) (in.)	22 x 27 ⁵ / ₈ x 58 ³ / ₄	22 x 27 ⁵ / ₈ x 58 ³ / ₄	42 ¹ / ₄ x 27 ⁵ / ₈ x 58 ³ / ₄	68 ¹ / ₄ x 27 ⁵ / ₈ x 58 ³ / ₄
# of Doors	1	1	2	3
# of Racks Accepted	1	1	2	3
# of Shelves (Size (L x D) (in.))	3 (23 ¹ / ₂ x 26 ³ / ₈)	3 (23 ¹ / ₂ x 26 ³ / ₈)	6 (22 ³ / ₄ x 26 ³ / ₈)	9 (22 ³ / ₄ x 26 ³ / ₈ (L/R), 25 x 26 ³ / ₈ (M))
Net Weight (lbs.)	269	269	424	730
Gross Weight (lbs.)	314	314	482	798

Design and specifications subject to change without notice. Most updated spec sheets are available at www.turboairinc.com.

Actual shipping weight may differ due to extra packing materials for product protection.

* Depth does not include 1-1/4" for door handles. † Height does not include 5" for caster height.

■ **WARRANTY: 3 Year Parts and Labor Warranty**

HALF GLASS DOOR HEATED CABINETS

■ **Digital temperature control & monitor system**

- Keeps food products safe by maintaining constant temperatures
- Alarm beeps when doors are not sealed
- Early warning alarm program detects issues before malfunction occurs
- Digital display allows for easy monitoring
- Sensitive touch display

■ **Ducted fan air distribution system**

Maintains temperature within the food zone.

■ **On/Off switch**

ON/OFF switch is located on control panel

■ **All stainless steel cabinet construction**

The PRO series model boasts a stainless steel interior and a **22 gauge** stainless steel exterior (galvanized steel top, bottom). It guarantees the utmost in cleanliness and long product life. The PRO series model adds a touch of style to the most refined setting.

■ **Sturdy, clean stainless steel shelving**

Only the Turbo Air PRO series uniquely provides stainless steel shelving. Shelves are the most important part of cleanliness as they come in direct contact with food. After a while, PVC coated wire shelves may peel, rust and lead to unsanitary conditions.

■ **LED interior lighting**

■ **High-density polyurethane insulation**

Structure and solid doors are foamed-in-place using high density, CFC free polyurethane insulation.

■ **Half length glass doors with locks**

■ **Self-closing doors with stay open feature at 120 degrees**

■ **Left hinged models available**
(PRO-26-2H-G-L, PRO-26-2H2-G-L)

■ **Heated cabinet holds 140°F ~ 180°F for the best in food preservation**



PRO-50-4H-G

PRO-26-2H-G

■ **Standard features**

- Door locks
- 4" dia. swivel casters with locks on the front set
- Easy replaceable one piece magnetic door gaskets
- Solid and sturdy grille design
- Lead time applies

■ **Optional features**

- Legs available for all models
- Tray slides available

PRO-H-G MODELS SPECIFICATIONS

ELECTRICAL DATA	PRO-26-2H-G	PRO-26-2H2-G	PRO-50-4H-G	PRO-77-6H-G
Voltage	115/60/1	208/115/60/1	208/115/60/1	208/115/60/1
Plug Type	⊖ NEMA L14-20P	⊖ NEMA L14-20P	⊕ NEMA L14-20P	⊕ NEMA L14-20P
Full Load Amp.	13.5	7.5	15	15
Wattage (W)	1550	1550	3000	3000
Cord Length (ft.)	8	8	8	8
DIMENSIONAL DATA				
Net Capacity (cu. ft.)	26.0	26.0	49.0	76.0
Ext. Dimension (L x D [*] x H [†]) (in.)	28 ³ / ₄ x 33 ⁷ / ₈ x 78	28 ³ / ₄ x 33 ⁷ / ₈ x 78	51 ³ / ₄ x 33 ⁷ / ₈ x 78	77 ³ / ₄ x 33 ⁷ / ₈ x 78
Int. Dimension (L x D x H) (in.)	22 x 27 ⁵ / ₈ x 58 ³ / ₄	22 x 27 ⁵ / ₈ x 58 ³ / ₄	42 ¹ / ₄ x 27 ⁵ / ₈ x 58 ³ / ₄	68 ¹ / ₄ x 27 ⁵ / ₈ x 58 ³ / ₄
# of Doors	2	2	4	6
# of Racks Accepted	1	1	2	3
# of Shelves (Size (L x D) (in.))	3 (23 ¹ / ₂ x 26 ³ / ₈)	3 (23 ¹ / ₂ x 26 ³ / ₈)	6 (22 ³ / ₄ x 26 ³ / ₈)	9 (22 ³ / ₄ x 26 ³ / ₈ (L/R), 25 x 26 ³ / ₈ (M))
Net Weight (lbs.)	275	275	442	748
Gross Weight (lbs.)	320	320	500	816

Design and specifications subject to change without notice. Most updated spec sheets are available at www.turboairinc.com.

Actual shipping weight may differ due to extra packing materials for product protection.

* Depth does not include 1-1/4" for door handles. † Height does not include 5" for caster height.

■ **WARRANTY: 3 Year Parts and Labor Warranty**

PASS-THRU SOLID DOOR HEATED CABINETS

■ **Digital temperature control & monitor system**

- Keeps food products safe by maintaining constant temperatures
- Alarm beeps when doors are not sealed
- Early warning alarm program detects issues before malfunction occurs
- Digital display allows for easy monitoring
- Sensitive touch display

■ **Ducted fan air distribution system**

Maintains temperature within the food zone.

■ **On/Off switch**

ON/OFF switch is located on control panel

■ **All stainless steel cabinet construction**

The PRO series model boasts a stainless steel interior and a 22 gauge stainless steel exterior (galvanized steel top, bottom). It guarantees the utmost in cleanliness and long product life. The PRO series model adds a touch of style to the most refined setting.

■ **Sturdy, clean stainless steel shelving**

Only the Turbo Air PRO series uniquely provides stainless steel shelving. Shelves are the most important part of cleanliness as they come in direct contact with food. After a while, PVC coated wire shelves may peel, rust and lead to unsanitary conditions.

■ **LED interior lighting**

■ **High-density polyurethane insulation**

Structure and solid doors are foamed-in-place using high density, CFC free polyurethane insulation.

■ **Full length stainless steel doors with locks**

■ **Self-closing doors with stay open feature at 120 degrees**

■ **Left hinged (PRO-26H-PT-L, PRO-26H2-PT-L), front left hinged & back right hinged (PRO-26H-PT-LR, PRO-26H2-PT-LR), front right hinged & back left hinged (PRO-26H-PT-RL, PRO-26H2-PT-RL) models available**



■ **Heated cabinet holds 140°F ~ 180°F for the best in food preservation**

■ **Standard features**

- Door locks
- 4" dia. swivel casters with locks on the front set
- Easy replaceable one piece magnetic door gaskets
- Solid and sturdy grille design
- Lead time applies

■ **Optional features**

- Legs available for all models
- Tray slides available

PRO-H-PT MODELS SPECIFICATIONS

ELECTRICAL DATA	PRO-26H-PT	PRO-26H2-PT	PRO-50H-PT	PRO-77H-PT
Voltage	115/60/1	208/115/60/1	208/115/60/1	208/115/60/1
Plug Type	Ⓜ NEMA 5-15P	Ⓜ NEMA L14-20P	Ⓜ NEMA L14-20P	Ⓜ NEMA L14-20P
Full Load Amp.	13.5	7.5	15	15
Wattage (W)	1550	1550	3000	3000
Cord Length (ft.)	8	8	8	8
DIMENSIONAL DATA				
Net Capacity (cu. ft.)	26.0	26.0	51.0	79.0
Ext. Dimension (L x D x H) (in.)	28 ³ / ₄ x 36 ¹ / ₄ x 78	28 ³ / ₄ x 36 ¹ / ₄ x 78	51 ³ / ₄ x 36 ¹ / ₄ x 78	77 ³ / ₄ x 36 ¹ / ₄ x 78
Int. Dimension (L x D x H) (in.)	22 x 27 ⁵ / ₈ x 58 ³ / ₄	22 x 27 ⁵ / ₈ x 58 ³ / ₄	42 ¹ / ₄ x 27 ³ / ₄ x 58 ³ / ₄	68 ¹ / ₄ x 27 ³ / ₄ x 58 ³ / ₄
# of Doors	2	2	4	6
# of Racks Accepted	1	1	2	3
# of Shelves (Size (L x D) (in.))	3 (23 ¹ / ₂ x 26 ³ / ₈)	3 (23 ¹ / ₂ x 26 ³ / ₈)	6 (22 ³ / ₄ x 26 ³ / ₈)	9 (22 ³ / ₄ x 26 ³ / ₈ (L/R), 25 x 26 ³ / ₈ (M))
Net Weight (lbs.)	279	279	452	730
Gross Weight (lbs.)	324	324	510	798

Design and specifications subject to change without notice. Most updated spec sheets are available at www.turboairinc.com.

Actual shipping weight may differ due to extra packing materials for product protection.

* Depth does not include 2-1/2" for door handles. † Height does not include 5" for caster height.

■ **WARRANTY: 3 Year Parts and Labor Warranty**

PASS-THRU HALF SOLID DOOR HEATED CABINETS

■ **Digital temperature control & monitor system**

- Keeps food products safe by maintaining constant temperatures
- Alarm beeps when doors are not sealed
- Early warning alarm program detects issues before malfunction occurs
- Digital display allows for easy monitoring
- Sensitive touch display

■ **Ducted fan air distribution system**

Maintains temperature within the food zone.

■ **On/Off switch**

ON/OFF switch is located on control panel

■ **All stainless steel cabinet construction**

The PRO series model boasts a stainless steel interior and a **22 gauge** stainless steel exterior (galvanized steel top, bottom). It guarantees the utmost in cleanliness and long product life. The PRO series model adds a touch of style to the most refined setting.

■ **Sturdy, clean stainless steel shelving**

Only the Turbo Air PRO series uniquely provides stainless steel shelving. Shelves are the most important part of cleanliness as they come in direct contact with food. After a while, PVC coated wire shelves may peel, rust and lead to unsanitary conditions.

■ **LED interior lighting**

■ **High-density polyurethane insulation**

Structure and solid doors are foamed-in-place using high density, CFC free polyurethane insulation.

■ **Half length stainless steel doors with locks**

■ **Self-closing doors with stay open feature at 120 degrees**

■ **Left hinged (PRO-26-2H-PT-L, PRO-26-2H2-PT-L), front left hinged & back right hinged (PRO-26-2H-PT-LR, PRO-26-2H2-PT-LR), front right hinged & back left hinged (PRO-26-2H-PT-RL, PRO-26-2H2-PT-RL), all left hinged (PRO-50-4H-PT-AL), all right hinged (PRO-50-4H-PT-AR) models available**



PRO-50-4H-PT

PRO-26-2H-PT

■ **Heated cabinet holds 140°F ~ 180°F for the best in food preservation**

■ **Standard features**

- Door locks
- 4" dia. swivel casters with locks on the front set
- Easy replaceable one piece magnetic door gaskets
- Solid and sturdy grille design
- Lead time applies

■ **Optional features**

- Legs available for all models
- Tray slides available

PRO-H-PT MODELS SPECIFICATIONS

ELECTRICAL DATA	PRO-26-2H-PT	PRO-26-2H2-PT	PRO-50-4H-PT	PRO-77-6H-PT
Voltage	115/60/1	208/115/60/1	208/115/60/1	208/115/60/1
Plug Type	Ⓜ NEMA 5-15P	Ⓜ NEMA L14-20P	Ⓜ NEMA L14-20P	Ⓜ NEMA L14-20P
Full Load Amp.	13.5	7.5	15	15
Wattage (W)	1550	1550	3000	3000
Cord Length (ft.)	8	8	8	8
DIMENSIONAL DATA				
Net Capacity (cu. ft.)	26.0	26.0	48.7	78.1
Ext. Dimension (L x D [*] x H [†]) (in.)	28 ³ / ₄ x 36 ¹ / ₄ x 78	28 ³ / ₄ x 36 ¹ / ₄ x 78	51 ³ / ₄ x 36 ¹ / ₄ x 78	77 ³ / ₄ x 36 ¹ / ₄ x 78
Int. Dimension (L x D x H) (in.)	22 x 27 ³ / ₄ x 58 ³ / ₄	22 x 27 ³ / ₄ x 58 ³ / ₄	42 ¹ / ₄ x 27 ³ / ₄ x 58 ³ / ₄	68 ¹ / ₄ x 27 ³ / ₄ x 58 ³ / ₄
# of Doors	4	4	8	12
# of Racks Accepted	1	1	2	3
# of Shelves (Size (L x D) (in.))	3 (23 ¹ / ₂ x 26 ³ / ₈)	3 (23 ¹ / ₂ x 26 ³ / ₈)	6 (22 ³ / ₄ x 26 ³ / ₈)	9 (22 ³ / ₄ x 26 ³ / ₈ (L/R), 25 x 26 ³ / ₈ (M))
Net Weight (lbs.)	301	301	452	826
Gross Weight (lbs.)	346	346	510	894

Design and specifications subject to change without notice. Most updated spec sheets are available at www.turboairinc.com.

Actual shipping weight may differ due to extra packing materials for product protection.

* Depth does not include 2-1/2" for door handles. † Height does not include 5" for caster height.

■ **WARRANTY: 3 Year Parts and Labor Warranty**

PASS-THRU GLASS DOOR HEATED CABINETS

- **Digital temperature control & monitor system**
 - Keeps food products safe by maintaining constant temperatures
 - Alarm beeps when doors are not sealed
 - Early warning alarm program detects issues before malfunction occurs
 - Digital display allows for easy monitoring
 - Sensitive touch display
- **Ducted fan air distribution system**
Maintains temperature within the food zone.
- **On/Off switch**
ON/OFF switch is located on control panel
- **All stainless steel cabinet construction**
The PRO series model boasts a stainless steel interior and a **22 gauge** stainless steel exterior (galvanized steel top, bottom). It guarantees the utmost in cleanliness and long product life. The PRO series model adds a touch of style to the most refined setting.
- **Sturdy, clean stainless steel shelving**
Only the Turbo Air PRO series uniquely provides stainless steel shelving. Shelves are the most important part of cleanliness as they come in direct contact with food. After a while, PVC coated wire shelves may peel, rust and lead to unsanitary conditions.
- **LED interior lighting**
- **High-density polyurethane insulation**
Structure and solid doors are foamed-in-place using high density, CFC free polyurethane insulation.
- **Full length glass doors with locks**
- **Self-closing doors with stay open feature at 120 degrees**
- **Left hinged (PRO-26H-G-PT-L, PRO-26H2-G-PT-L), front left hinged & black right hinged (PRO-26H-G-PT-LR, PRO-26H2-G-PT-LR), front right hinged & back left hinged right (PRO-26H-G-PT-RL, PRO-26H2-G-PT-RL) models available**



PRO-50H-G-PT

PRO-77H-G-PT

- **Heated cabinet holds 140°F ~ 180°F for the best in food preservation**
- **Standard features**
 - Door locks
 - 4" dia. swivel casters with locks on the front set
 - Easy replaceable one piece magnetic door gaskets
 - Solid and sturdy grille design
 - Lead time applies
- **Optional features**
 - Legs available for all models
 - Tray slides available

PRO-H-G-PT MODELS SPECIFICATIONS

ELECTRICAL DATA	PRO-26H-G-PT	PRO-26H2-G-PT	PRO-50H-G-PT	PRO-77H-G-PT
Voltage	115/60/1	208/115/60/1	208/115/60/1	208/115/60/1
Plug Type	Ⓜ NEMA 5-15P	Ⓜ NEMA L14-20P	Ⓜ NEMA L14-20P	Ⓜ NEMA L14-20P
Full Load Amp.	13.5	7.5	15	15
Wattage (W)	1550	1550	3000	3000
Cord Length (ft.)	8	8	8	8
DIMENSIONAL DATA				
Net Capacity (cu. ft.)	28.0	28.0	48.7	78.1
Ext. Dimension (L x D x HT) (in.)	28 3/4 x 36 1/4 x 78	28 3/4 x 36 1/4 x 78	51 3/4 x 36 1/4 x 78	77 3/4 x 36 1/4 x 78
Int. Dimension (L x D x H) (in.)	22 x 27 5/8 x 58 3/4	22 x 27 5/8 x 58 3/4	42 1/4 x 27 3/4 x 58 3/4	68 1/4 x 27 3/4 x 58 3/4
# of Doors	2	2	4	6
# of Racks Accepted	1	1	2	3
# of Shelves (Size (L x D) (in.))	3 (23 1/2 x 26 3/8)	3 (23 1/2 x 26 3/8)	6 (22 3/4 x 26 3/8)	9 (22 3/4 x 26 3/8 (L/R), 25 x 26 3/8 (M))
Net Weight (lbs.)	299	299	492	856
Gross Weight (lbs.)	344	344	550	924

Design and specifications subject to change without notice. Most updated spec sheets are available at www.turboairinc.com.

Actual shipping weight may differ due to extra packing materials for product protection.

* Depth does not include 2-1/2" for door handles. † Height does not include 5" for caster height.

- **WARRANTY: 3 Year Parts and Labor Warranty**

PASS-THRU HALF GLASS DOOR HEATED CABINETS

■ **Digital temperature control & monitor system**

- Keeps food products safe by maintaining constant temperatures
- Alarm beeps when doors are not sealed
- Early warning alarm program detects issues before malfunction occurs
- Digital display allows for easy monitoring
- Sensitive touch display

■ **Ducted fan air distribution system**

Maintains temperature within the food zone.

■ **On/Off switch**

ON/OFF switch is located on control panel

■ **All stainless steel cabinet construction**

The PRO series model boasts a stainless steel interior and a 22 gauge stainless steel exterior (galvanized steel top, bottom). It guarantees the utmost in cleanliness and long product life. The PRO series model adds a touch of style to the most refined setting.

■ **Sturdy, clean stainless steel shelving**

Only the Turbo Air PRO series uniquely provides stainless steel shelving. Shelves are the most important part of cleanliness as they come in direct contact with food. After a while, PVC coated wire shelves may peel, rust and lead to unsanitary conditions.

■ **LED interior lighting**

■ **High-density polyurethane insulation**

Structure and solid doors are foamed-in-place using high density, CFC free polyurethane insulation.

■ **Half length glass doors with locks**

■ **Self-closing doors with stay open feature at 120 degrees**

■ **Left hinged (PRO-26-2H-G-PT-L, PRO-26-2H2-G-PT-L), front left hinged & back right hinged (PRO-26-2H-G-PT-LR, PRO-26-2H2-G-PT-LR), front right hinged & back left hinged (PRO-26-2H-G-PT-RL, PRO-26-2H2-G-PT-RL) models available**

■ **Heated cabinet holds 140°F ~ 180°F for the best in food preservation**



PRO-26-2H-G-PT

PRO-50-4H-G-PT

■ **Standard features**

- Door locks
- 4" dia. swivel casters with locks on the front set
- Easy replaceable one piece magnetic door gaskets
- Solid and sturdy grille design
- Lead time applies

■ **Optional features**

- Legs available for all models
- Tray slides available

PRO-H-G-PT MODELS SPECIFICATIONS

ELECTRICAL DATA	PRO-26-2H-G-PT	PRO-26-2H2-G-PT	PRO-50-4H-G-PT	PRO-77-6H-G-PT
Voltage	115/60/1	208/115/60/1	208/115/60/1	208/115/60/1
Plug Type	Ⓢ NEMA 5-15P	Ⓢ NEMA L14-20P	Ⓢ NEMA L14-20P	Ⓢ NEMA L14-20P
Full Load Amp.	13.5	7.5	15	15
Wattage (W)	1550	1550	3000	3000
Cord Length (ft.)	8	8	8	8
DIMENSIONAL DATA				
Net Capacity (cu. ft.)	28.0	28.0	48.7	78.1
Ext. Dimension (L x D* x H†) (in.)	28 ³ / ₄ x 36 ¹ / ₄ x 78	28 ³ / ₄ x 36 ¹ / ₄ x 78	51 ³ / ₄ x 36 ¹ / ₄ x 78	77 ³ / ₄ x 36 ¹ / ₄ x 78
Int. Dimension (L x D x H) (in.)	22 x 27 ³ / ₄ x 58 ³ / ₄	22 x 27 ³ / ₄ x 58 ³ / ₄	42 ¹ / ₄ x 27 ³ / ₄ x 58 ³ / ₄	68 ¹ / ₄ x 27 ⁵ / ₈ x 58 ³ / ₄
# of Doors	4	4	8	12
# of Racks Accepted	1	1	2	3
# of Shelves (Size (L x D) (in.))	3 (23 ¹ / ₂ x 26 ³ / ₈)	3 (23 ¹ / ₂ x 26 ³ / ₈)	6 (22 ³ / ₄ x 26 ³ / ₈)	9 (22 ³ / ₄ x 26 ³ / ₈ (L/R), 25 x 26 ³ / ₈ (M))
Net Weight (lbs.)	321	321	492	856
Gross Weight (lbs.)	366	366	550	924

Design and specifications subject to change without notice. Most updated spec sheets are available at www.turboairinc.com.

Actual shipping weight may differ due to extra packing materials for product protection.

* Depth does not include 2-1/2" for door handles. † Height does not include 5" for caster height.

■ **WARRANTY: 3 Year Parts and Labor Warranty**

PASS-THRU SOLID & GLASS DOOR HEATED CABINETS

- **Digital temperature control & monitor system**
 - Keeps food products safe by maintaining constant temperatures
 - Alarm beeps when doors are not sealed
 - Early warning alarm program detects issues before malfunction occurs
 - Digital display allows for easy monitoring
 - Sensitive touch display
- **Ducted fan air distribution system**
Maintains temperature within the food zone.
- **On/Off switch**
ON/OFF switch is located on control panel
- **All stainless steel cabinet construction**
The PRO series model boasts a stainless steel interior and a **22 gauge** stainless steel exterior (galvanized steel top, bottom). It guarantees the utmost in cleanliness and long product life. The PRO series model adds a touch of style to the most refined setting.
- **Sturdy, clean stainless steel shelving**
Only the Turbo Air PRO series uniquely provides stainless steel shelving. Shelves are the most important part of cleanliness as they come in direct contact with food. After a while, PVC coated wire shelves may peel, rust and lead to unsanitary conditions.
- **LED interior lighting**
- **High-density polyurethane insulation**
Structure and solid doors are foamed-in-place using high density, CFC free polyurethane insulation.
- **GS models: (front) glass + (back) solid door**
SG models: (front) solid + (back) glass door
- **Self-closing doors with stay open feature at 120 degrees**
- **Left hinged models available (PRO-26H-GS-PT-L, PRO-26H2-GS-PT-L, PRO-26H-SG-PT-L, PRO-26H2-SG-PT-L)**
- **Heated cabinet holds 140°F ~ 180°F for the best in food preservation**



PRO-26H-GS-PT



PRO-26H-SG-PT

- **Standard features**
 - Door locks
 - 4" dia. swivel casters with locks on the front set
 - Easy replaceable one piece magnetic door gaskets
 - Solid and sturdy grille design
 - Lead time applies
- **Optional features**
 - Legs available for all models
 - Tray slides available

PRO-H-GS/SG-PT MODELS SPECIFICATIONS

ELECTRICAL DATA	PRO-26H-GS-PT	PRO-26H2-GS-PT	PRO-26H-SG-PT	PRO-26H2-SG-PT
Voltage	115/60/1	208/115/60/1	115/60/1	208/115/60/1
Plug Type	Ⓜ NEMA 5-15P	Ⓜ NEMA L14-20P	Ⓜ NEMA 5-15P	Ⓜ NEMA L14-20P
Full Load Amp.	13.5	7.5	13.5	7.5
Wattage (W)	1550	1550	1550	1550
Cord Length (ft.)	8	8	8	8
DIMENSIONAL DATA				
Net Capacity (cu. ft.)	27.0	27.0	27.0	27.0
Ext. Dimension (L x D x H†) (in.)	28 ³ / ₄ x 36 ¹ / ₄ x 78	28 ³ / ₄ x 36 ¹ / ₄ x 78	28 ³ / ₄ x 36 ¹ / ₄ x 78	28 ³ / ₄ x 36 ¹ / ₄ x 78
Int. Dimension (L x D x H) (in.)	23 ⁷ / ₈ x 27 ³ / ₄ x 58 ³ / ₄	23 ⁷ / ₈ x 27 ³ / ₄ x 58 ³ / ₄	23 ⁷ / ₈ x 27 ³ / ₄ x 58 ³ / ₄	23 ⁷ / ₈ x 27 ³ / ₄ x 58 ³ / ₄
# of Doors	2	2	2	2
# of Racks Accepted	1	1	1	1
# of Shelves (Size (L x D) (in.))	3 (23 ¹ / ₂ x 26 ³ / ₈)	3 (23 ¹ / ₂ x 26 ³ / ₈)	3 (23 ¹ / ₂ x 26 ³ / ₈)	3 (23 ¹ / ₂ x 26 ³ / ₈)
Net Weight (lbs.)	297	297	297	297
Gross Weight (lbs.)	342	342	342	342

Design and specifications subject to change without notice. Most updated spec sheets are available at www.turboairinc.com.

Actual shipping weight may differ due to extra packing materials for product protection.

* Depth does not include 2-1/2" for door handles. † Height does not include 5" for caster height.

■ **WARRANTY: 3 Year Parts and Labor Warranty**

PASS-THRU SOLID & GLASS DOOR HEATED CABINETS

■ **Digital temperature control & monitor system**

- Keeps food products safe by maintaining constant temperatures
- Alarm beeps when doors are not sealed
- Early warning alarm program detects issues before malfunction occurs
- Digital display allows for easy monitoring
- Sensitive touch display

■ **Ducted fan air distribution system**

Maintains temperature within the food zone.

■ **On/Off switch**

ON/OFF switch is located on control panel

■ **All stainless steel cabinet construction**

The PRO series model boasts a stainless steel interior and a 22 gauge stainless steel exterior (galvanized steel top, bottom). It guarantees the utmost in cleanliness and long product life. The PRO series model adds a touch of style to the most refined setting.

■ **Sturdy, clean stainless steel shelving**

Only the Turbo Air PRO series uniquely provides stainless steel shelving. Shelves are the most important part of cleanliness as they come in direct contact with food. After a while, PVC coated wire shelves may peel, rust and lead to unsanitary conditions.

■ **LED interior lighting**

■ **High-density polyurethane insulation**

Structure and solid doors are foamed-in-place using high density, CFC free polyurethane insulation.

■ **GS models: (front) glass + (back) solid door**
SG models: (front) solid + (back) glass door

■ **Self-closing doors with stay open feature at 120 degrees**

■ **Heated cabinet holds 140°F ~ 180°F for the best in food preservation**

■ **Standard features**

- Door locks
- 4" dia. swivel casters with locks on the front set
- Easy replaceable one piece magnetic door gaskets
- Solid and sturdy grille design
- Lead time applies

■ **Optional features**

- Legs available for all models
- Tray slides available



PRO-50H-GS-PT

PRO-77H-SG-PT

PRO-H-GS/SG-PT MODELS SPECIFICATIONS

ELECTRICAL DATA	PRO-50H-GS-PT	PRO-50H-SG-PT	PRO-77H-GS-PT	PRO-77H-SG-PT
Voltage	208/115/60/1	208/115/60/1	208/115/60/1	208/115/60/1
Plug Type	☺ NEMA L14-20P	☺ NEMA L14-20P	☺ NEMA L14-20P	☺ NEMA L14-20P
Full Load Amp.	15	15	15	15
Wattage (W)	3000	3000	3000	3000
Cord Length (ft.)	8	8	8	8
DIMENSIONAL DATA				
Net Capacity (cu. ft.)	53.0	53.0	79.0	79.0
Ext. Dimension (L x D x H†) (in.)	51 3/4 x 36 1/4 x 78	51 3/4 x 36 1/4 x 78	77 3/4 x 36 1/4 x 78	77 3/4 x 36 1/4 x 78
Int. Dimension (L x D x H) (in.)	42 1/4 x 27 3/4 x 58 3/4	42 1/4 x 27 3/4 x 58 3/4	68 1/4 x 27 3/4 x 58 3/4	68 1/4 x 27 3/4 x 58 3/4
# of Doors	4	4	6	6
# of Racks Accepted	2	2	3	3
# of Shelves (Size (L x D) (in.))	6 (22 3/4 x 26 3/8)	6 (22 3/4 x 26 3/8)	9 (22 3/4 x 26 3/8 (L/R), 25 x 26 3/8 (M))	9 (22 3/4 x 26 3/8 (L/R), 25 x 26 3/8 (M))
Net Weight (lbs.)	442	442	760	760
Gross Weight (lbs.)	500	500	828	828

Design and specifications subject to change without notice. Most updated spec sheets are available at www.turboairinc.com.

Actual shipping weight may differ due to extra packing materials for product protection.

* Depth does not include 2-1/2" for door handles. † Height does not include 5" for caster height.

■ **WARRANTY: 3 Year Parts and Labor Warranty**

PASS-THRU SOLID & GLASS DOOR HEATED CABINETS

■ **Digital temperature control & monitor system**

- Keeps food products safe by maintaining constant temperatures
- Alarm beeps when doors are not sealed
- Early warning alarm program detects issues before malfunction occurs
- Digital display allows for easy monitoring
- Sensitive touch display

■ **Ducted fan air distribution system**

Maintains temperature within the food zone.

■ **On/Off switch**

ON/OFF switch is located on control panel

■ **All stainless steel cabinet construction**

The PRO series model boasts a stainless steel interior and a 22 gauge stainless steel exterior (galvanized steel top, bottom). It guarantees the utmost in cleanliness and long product life. The PRO series model adds a touch of style to the most refined setting.

■ **Sturdy, clean stainless steel shelving**

Only the Turbo Air PRO series uniquely provides stainless steel shelving. Shelves are the most important part of cleanliness as they come in direct contact with food. After a while, PVC coated wire shelves may peel, rust and lead to unsanitary conditions.

■ **LED interior lighting**

■ **High-density polyurethane insulation**

Structure and solid doors are foamed-in-place using high density, CFC free polyurethane insulation.

- **GS models: (front) glass + (back) solid door**
- **SG models: (front) solid + (back) glass door**

■ **Self-closing doors with stay open feature at 120 degrees**

- **Left hinged (PRO-26-2H-GS-PT-L, PRO-26-2H2-GS-PT-L, PRO-26-2H-SG-PT-L, PRO-26-2H2-SG-PT-L), front left hinged & back right hinged (PRO-26-2H-GS-PT-LR, PRO-26-2H2-GS-PT-LR, PRO-26-2H-SG-PT-LR, PRO-26-2H2-SG-PT-LR), front right hinged & back left hinged (PRO-26-2H-GS-PT-RL, PRO-26-2H2-GS-PT-RL, PRO-26-2H-SG-PT-RL, PRO-26-2H2-SG-PT-RL) models available**



PRO-26-2H-GS-PT

PRO-26-2H-SG-PT

■ **Heated cabinet holds 140°F ~ 180°F for the best in food preservation**

■ **Standard features**

- Door locks
- 4" dia. swivel casters with locks on the front set
- Easy replaceable one piece magnetic door gaskets
- Solid and sturdy grille design
- Lead time applies

■ **Optional features**

- Legs available for all models
- Tray slides available

PRO-H-GS/SG-PT MODELS SPECIFICATIONS

ELECTRICAL DATA	PRO-26-2H-GS-PT	PRO-26-2H2-GS-PT	PRO-26-2H-SG-PT	PRO-26-2H2-SG-PT
Voltage	115/60/1	208/115/60/1	115/60/1	115/60/1
Plug Type	Ⓜ NEMA 5-15P	Ⓜ NEMA L14-20P	Ⓜ NEMA 5-15P	Ⓜ NEMA L14-20P
Full Load Amp.	13.5	7.5	13.5	13.5
Wattage (W)	1550	1550	1550	1550
Cord Length (ft.)	8	8	8	8
DIMENSIONAL DATA				
Net Capacity (cu. ft.)	27.0	27.0	27.0	27.0
Ext. Dimension (L x D x H) (in.)	28 ³ / ₄ x 36 ¹ / ₄ x 78	28 ³ / ₄ x 36 ¹ / ₄ x 78	28 ³ / ₄ x 36 ¹ / ₄ x 78	28 ³ / ₄ x 36 ¹ / ₄ x 78
Int. Dimension (L x D x H) (in.)	23 ⁷ / ₈ x 27 ³ / ₄ x 58 ³ / ₄	23 ⁷ / ₈ x 27 ³ / ₄ x 58 ³ / ₄	23 ⁷ / ₈ x 27 ³ / ₄ x 58 ³ / ₄	23 ⁷ / ₈ x 27 ³ / ₄ x 58 ³ / ₄
# of Doors	4	4	4	4
# of Racks Accepted	1	1	1	1
# of Shelves (Size (L x D) (in.))	3 (23 ¹ / ₂ x 26 ³ / ₈)	3 (23 ¹ / ₂ x 26 ³ / ₈)	3 (23 ¹ / ₂ x 26 ³ / ₈)	3 (23 ¹ / ₂ x 26 ³ / ₈)
Net Weight (lbs.)	297	297	297	297
Gross Weight (lbs.)	342	342	342	342

Design and specifications subject to change without notice. Most updated spec sheets are available at www.turboairinc.com.

Actual shipping weight may differ due to extra packing materials for product protection.

* Depth does not include 2-1/2" for door handles. † Height does not include 5" for caster height.

■ **WARRANTY: 3 Year Parts and Labor Warranty**

PASS-THRU SOLID & GLASS DOOR HEATED CABINETS

■ **Digital temperature control & monitor system**

- Keeps food products safe by maintaining constant temperatures
- Alarm beeps when doors are not sealed
- Early warning alarm program detects issues before malfunction occurs
- Digital display allows for easy monitoring
- Sensitive touch display

■ **Ducted fan air distribution system**

Maintains temperature within the food zone.

■ **On/Off switch**

ON/OFF switch is located on control panel

■ **All stainless steel cabinet construction**

The PRO series model boasts a stainless steel interior and a **22 gauge** stainless steel exterior (galvanized steel top, bottom). It guarantees the utmost in cleanliness and long product life. The PRO series model adds a touch of style to the most refined setting.

■ **Sturdy, clean stainless steel shelving**

Only the Turbo Air PRO series uniquely provides stainless steel shelving. Shelves are the most important part of cleanliness as they come in direct contact with food. After a while, PVC coated wire shelves may peel, rust and lead to unsanitary conditions.

■ **LED interior lighting**

■ **High-density polyurethane insulation**

Structure and solid doors are foamed-in-place using high density, CFC free polyurethane insulation.

- **GS models: (front) glass + (back) solid door**
- **SG models: (front) solid + (back) glass door**

■ **Self-closing doors with stay open feature at 120 degrees**

■ **Heated cabinet holds 140°F ~ 180°F for the best in food preservation**

■ **Standard features**

- Door locks
- 4" dia. swivel casters with locks on the front set
- Easy replaceable one piece magnetic door gaskets
- Solid and sturdy grille design
- Lead time applies



PRO-77-6H-GS-PT



PRO-50-4H-SG-PT

■ **Optional features**

- Legs available for all models
- Tray slides available

PRO-H-GS/SG-PT MODELS SPECIFICATIONS

ELECTRICAL DATA	PRO-50-4H-GS-PT	PRO-50-4H-SG-PT	PRO-77-6H-GS-PT	PRO-77-6H-SG-PT
Voltage	208/115/60/1	208/115/60/1	208/115/60/1	208/115/60/1
Plug Type	☺ NEMA L14-20P	☺ NEMA L14-20P	☺ NEMA L14-20P	☺ NEMA L14-20P
Full Load Amp.	15	15	15	15
Wattage (W)	3000	3000	3000	3000
Cord Length (ft.)	8	8	8	8
DIMENSIONAL DATA				
Net Capacity (cu. ft.)	53.0	53.0	81.0	81.0
Ext. Dimension (L x D [*] x H [†]) (in.)	51 ³ / ₄ x 36 ¹ / ₄ x 78	51 ³ / ₄ x 36 ¹ / ₄ x 78	77 ³ / ₄ x 36 ¹ / ₄ x 78	77 ³ / ₄ x 36 ¹ / ₄ x 78
Int. Dimension (L x D x H) (in.)	42 ¹ / ₄ x 27 ³ / ₄ x 58 ³ / ₄	42 ¹ / ₄ x 27 ³ / ₄ x 58 ³ / ₄	68 ¹ / ₄ x 27 ³ / ₄ x 58 ³ / ₄	68 ¹ / ₄ x 27 ³ / ₄ x 58 ³ / ₄
# of Doors	8	8	12	12
# of Racks Accepted	2	2	3	3
# of Shelves (Size (L x D) (in.))	6 (22 ³ / ₄ x 26 ³ / ₈)	6 (22 ³ / ₄ x 26 ³ / ₈)	9 (22 ³ / ₄ x 26 ³ / ₈ (L/R), 25 x 26 ³ / ₈ (M))	9 (23 ¹ / ₂ x 26 ³ / ₈ (L/R), 25 x 26 ³ / ₈ (M))
Net Weight (lbs.)	472	472	841	841
Gross Weight (lbs.)	530	530	909	909

Design and specifications subject to change without notice. Most updated spec sheets are available at www.turboairinc.com.

Actual shipping weight may differ due to extra packing materials for product protection.

* Depth does not include 2-1/2" for door handles. † Height does not include 5" for caster height.

■ **WARRANTY: 3 Year Parts and Labor Warranty**

ROLL-IN SOLID DOOR HEATED CABINETS

■ **Digital temperature control & monitor system**

- Keeps food products safe by maintaining constant temperatures
- Alarm beeps when doors are not sealed
- Early warning alarm program detects issues before malfunction occurs
- Digital display allows for easy monitoring
- Sensitive touch display

■ **Ducted fan air distribution system**

Maintains temperature within the food zone.

■ **On/Off switch**

ON/OFF switch is located on control panel

■ **All stainless steel cabinet construction**

The PRO series model boasts a stainless steel interior and a **22 gauge** stainless steel exterior (galvanized steel top, bottom). It guarantees the utmost in cleanliness and long product life. The PRO series model adds a touch of style to the most refined setting.

■ **Sturdy, clean stainless steel shelving**

Only the Turbo Air PRO series uniquely provides stainless steel shelving. Shelves are the most important part of cleanliness as they come in direct contact with food. After a while, PVC coated wire shelves may peel, rust and lead to unsanitary conditions.

■ **LED interior lighting**

■ **High-density polyurethane insulation**

Structure and solid doors are foamed-in-place using high density, CFC free polyurethane insulation.

■ **Full length stainless steel doors with locks**

■ **Self-closing doors with stay open feature at 120 degrees**

■ **Left hinged models available**
(PRO-26H-RI-L, PRO-26H2-RI-L)

■ **Heated cabinet holds 140°F ~ 180°F for the best in food preservation**



PRO-26H-RI

PRO-50H-RI

■ **Standard features**

- Door locks
- 4" dia. swivel casters with locks on the front set
- Easy replaceable one piece magnetic door gaskets
- Solid and sturdy grille design
- Lead time applies

PRO-H-RI MODELS SPECIFICATIONS

ELECTRICAL DATA	PRO-26H-RI	PRO-26H2-RI	PRO-50H-RI	PRO-42H-RI	PRO-89H-RI
Voltage	115/60/1	208/115/60/1	208/115/60/1	115/60/1	208/115/60/1
Plug Type	Ⓢ NEMA 5-15P	Ⓢ NEMA L14-20P	Ⓢ NEMA L14-20P	Ⓢ NEMA 5-15P	Ⓢ NEMA L14-20P
Full Load Amp.	13.5	7.5	15	7	15
Wattage (W)	1550	1550	3000	1550	3000
Cord Length (ft.)	8	8	8	9	8
DIMENSIONAL DATA					
Net Capacity (cu. ft.)	35.51	35.51	75.59	41.4	86.7
Ext. Dimension (L x D [*] x H) (in.)	34 x 37 ³ / ₄ x 84 ¹ / ₄	34 x 37 ³ / ₄ x 84 ¹ / ₄	66 ⁷ / ₈ x 37 ³ / ₄ x 84 ¹ / ₄	34 x 38 x 89 ³ / ₄	66 ⁷ / ₈ x 37 ³ / ₄ x 89 ³ / ₄
Int. Dimension (L x D x H) (in.)	27 ³ / ₈ x 31 x 66 ⁷ / ₈	27 ³ / ₈ x 31 x 66 ⁷ / ₈	57 ³ / ₈ x 31 x 66 ⁷ / ₈	29 ³ / ₈ x 31 ¹ / ₂ x 74 ⁷ / ₈	58 ¹ / ₈ x 33 ³ / ₈ x 73 ³ / ₈
# of Doors	1	1	2	1	2
# of Racks Accepted	1	1	2	1	2
# of Shelves	-	-	-	-	-
Net Weight (lbs.)	391	391	641	410	661
Gross Weight (lbs.)	436	436	699	457	722

Design and specifications subject to change without notice. Most updated spec sheets are available at www.turboairinc.com.

Actual shipping weight may differ due to extra packing materials for product protection.

* Depth does not include 1-1/4" for door handles and 3-1/2" for ramps.

■ **WARRANTY: 3 Year Parts and Labor Warranty**

ROLL-IN GLASS DOOR HEATED CABINETS

■ **Digital temperature control & monitor system**

- Keeps food products safe by maintaining constant temperatures
- Alarm beeps when doors are not sealed
- Early warning alarm program detects issues before malfunction occurs
- Digital display allows for easy monitoring
- Sensitive touch display

■ **Ducted fan air distribution system**

Maintains temperature within the food zone.

■ **On/Off switch**

ON/OFF switch is located on control panel

■ **All stainless steel cabinet construction**

The PRO series model boasts a stainless steel interior and a **22 gauge** stainless steel exterior (galvanized steel top, bottom). It guarantees the utmost in cleanliness and long product life. The PRO series model adds a touch of style to the most refined setting.

■ **Sturdy, clean stainless steel shelving**

Only the Turbo Air PRO series uniquely provides stainless steel shelving. Shelves are the most important part of cleanliness as they come in direct contact with food. After a while, PVC coated wire shelves may peel, rust and lead to unsanitary conditions.

■ **LED interior lighting**

■ **High-density polyurethane insulation**

Structure and solid doors are foamed-in-place using high density, CFC free polyurethane insulation.

■ **Stainless steel door with glass window**

■ **Self-closing doors with stay open feature at 120 degrees**

■ **Left hinged models available**
(PRO-26H-G-RI-L, PRO-26H2-G-RI-L)

■ **Heated cabinet holds 140°F ~ 180°F for the best in food preservation**



PRO-50H-G-RI

PRO-26H-G-RI

■ **Standard features**

- Door locks
- 4" dia. swivel casters with locks on the front set
- Easy replaceable one piece magnetic door gaskets
- Solid and sturdy grille design
- Lead time applies

PRO-H-G-RI MODELS SPECIFICATIONS

ELECTRICAL DATA	PRO-26H-G-RI	PRO-26H2-G-RI	PRO-50H-G-RI
Voltage	115/60/1	208/115/60/1	208/115/60/1
Plug Type	Ⓜ NEMA 5-15P	Ⓜ NEMA L14-20P	Ⓜ NEMA L14-20P
Full Load Amp.	13.5	7.5	15
Wattage (W)	1550	1550	3000
Cord Length (ft.)	8	8	8
DIMENSIONAL DATA			
Net Capacity (cu. ft.)	35.51	35.51	75.59
Ext. Dimension (L x D x H) (in.)	34 x 37 ³ / ₄ x 84 ¹ / ₄	34 x 37 ³ / ₄ x 84 ¹ / ₄	66 ⁷ / ₈ x 37 ³ / ₄ x 84 ¹ / ₄
Int. Dimension (L x D x H) (in.)	27 ³ / ₈ x 31 x 66 ⁷ / ₈	27 ³ / ₈ x 31 x 66 ⁷ / ₈	57 ³ / ₈ x 31 x 66 ⁷ / ₈
# of Doors	1	1	2
# of Racks Accepted	1	1	2
# of Shelves	-	-	-
Net Weight (lbs.)	401	401	681
Gross Weight (lbs.)	446	446	739

Design and specifications subject to change without notice. Most updated spec sheets are available at www.turboairinc.com.

Actual shipping weight may differ due to extra packing materials for product protection.

* Depth does not include 1-1/4" for door handles and 3-1/2" for ramps.

■ **WARRANTY: 3 Year Parts and Labor Warranty**

ROLL-THRU SOLID DOOR HEATED CABINETS

■ **Digital temperature control & monitor system**

- Keeps food products safe by maintaining constant temperatures
- Alarm beeps when doors are not sealed
- Early warning alarm program detects issues before malfunction occurs
- Digital display allows for easy monitoring
- Sensitive touch display

■ **Ducted fan air distribution system**

Maintains temperature within the food zone.

■ **On/Off switch**

ON/OFF switch is located on control panel

■ **All stainless steel cabinet construction**

The PRO series model boasts a stainless steel interior and a 22 gauge stainless steel exterior (galvanized steel top, bottom). It guarantees the utmost in cleanliness and long product life. The PRO series model adds a touch of style to the most refined setting.

■ **Sturdy, clean stainless steel shelving**

Only the Turbo Air PRO series uniquely provides stainless steel shelving. Shelves are the most important part of cleanliness as they come in direct contact with food. After a while, PVC coated wire shelves may peel, rust and lead to unsanitary conditions.

■ **LED interior lighting**

■ **High-density polyurethane insulation**

Structure and solid doors are foamed-in-place using high density, CFC free polyurethane insulation.

■ **Full length stainless steel doors with locks**

■ **Self-closing doors with stay open feature at 120 degrees**

■ **Left hinged (PRO-26H-RT-L, PRO-26H2-RT-L), front left hinged & back right hinged (PRO-26H-RT-LR, PRO-26H2-RT-LR), front right hinged & back left hinged (PRO-26H-RT-RL, PRO-26H2-RT-RL) models available**

■ **Heated cabinet holds 140°F ~ 180°F for the best in food preservation**



PRO-26H-RT

PRO-50H-RT

■ **Standard features**

- Door locks
- 4" dia. swivel casters with locks on the front set
- Easy replaceable one piece magnetic door gaskets
- Solid and sturdy grille design
- Lead time applies

PRO-H-RT MODELS SPECIFICATIONS

ELECTRICAL DATA	PRO-26H-RT	PRO-26H2-RT	PRO-50H-RT
Voltage	115/60/1	208/115/60/1	208/115/60/1
Plug Type	Ⓢ NEMA 5-15P	Ⓢ NEMA L14-20P	Ⓢ NEMA L14-20P
Full Load Amp.	13.5	7.5	15
Wattage (W)	1550	1550	3000
Cord Length (ft.)	8	8	8
DIMENSIONAL DATA			
Net Capacity (cu. ft.)	42.0	42.0	82.0
Ext. Dimension (L x D x H) (in.)	34 x 40 1/8 x 84 1/4	34 x 40 1/8 x 84 1/4	66 7/8 x 40 1/8 x 84 1/4
Int. Dimension (L x D x H) (in.)	27 5/8 x 31 1/2 x 66 7/8	27 5/8 x 31 1/2 x 66 7/8	58 x 31 1/2 x 66 7/8
# of Doors	2	2	4
# of Racks Accepted	1	1	2
# of Shelves	-	-	-
Net Weight (lbs.)	439	439	738
Gross Weight (lbs.)	484	484	796

Design and specifications subject to change without notice. Most updated spec sheets are available at www.turboairinc.com.

Actual shipping weight may differ due to extra packing materials for product protection.

* Depth does not include 2-1/2" for door handles and 6-7/8" for ramps.

■ **WARRANTY: 3 Year Parts and Labor Warranty**

ROLL-THRU GLASS DOOR HEATED CABINETS

■ **Digital temperature control & monitor system**

- Keeps food products safe by maintaining constant temperatures
- Alarm beeps when doors are not sealed
- Early warning alarm program detects issues before malfunction occurs
- Digital display allows for easy monitoring
- Sensitive touch display

■ **Ducted fan air distribution system**

Maintains temperature within the food zone.

■ **On/Off switch**

ON/OFF switch is located on control panel

■ **All stainless steel cabinet construction**

The PRO series model boasts a stainless steel interior and a **22 gauge** stainless steel exterior (galvanized steel top, bottom). It guarantees the utmost in cleanliness and long product life. The PRO series model adds a touch of style to the most refined setting.

■ **Sturdy, clean stainless steel shelving**

Only the Turbo Air PRO series uniquely provides stainless steel shelving. Shelves are the most important part of cleanliness as they come in direct contact with food. After a while, PVC coated wire shelves may peel, rust and lead to unsanitary conditions.

■ **LED interior lighting**

■ **High-density polyurethane insulation**

Structure and solid doors are foamed-in-place using high density, CFC free polyurethane insulation.

■ **Stainless steel door with glass window**

■ **Self-closing doors with stay open feature at 120 degrees**

■ **Left hinged (PRO-26H-G-RT-L, PRO-26H2-G-RT-L), front left hinged & back right hinged (PRO-26H-G-RT-LR, PRO-26H2-G-RT-LR), front right hinged & back left hinged (PRO-26H-G-RT-RL, PRO-26H2-G-RT-RL) models available**



PRO-50H-G-RT

PRO-26H-G-RT

■ **Heated cabinet holds 140°F ~ 180°F for the best in food preservation**

■ **Standard features**

- Door locks
- 4" dia. swivel casters with locks on the front set
- Easy replaceable one piece magnetic door gaskets
- Solid and sturdy grille design
- Lead time applies

PRO-H-G-RT MODELS SPECIFICATIONS

ELECTRICAL DATA	PRO-26H-G-RT	PRO-26H2-G-RT	PRO-50H-G-RT
Voltage	115/60/1	115/60/1	208/115/60/1
Plug Type	Ⓜ NEMA 5-15P	Ⓜ NEMA 5-15P	Ⓜ NEMA L14-20P
Full Load Amp.	13.5	7.5	15
Wattage (W)	1550	1550	3000
Cord Length (ft.)	8	8	8
DIMENSIONAL DATA			
Net Capacity (cu. ft.)	44.0	44.0	86.0
Ext. Dimension (L x D x H) (in.)	34 x 40 1/8 x 84 1/4	34 x 40 1/8 x 84 1/4	66 7/8 x 40 1/8 x 84 1/4
Int. Dimension (L x D x H) (in.)	27 5/8 x 31 1/2 x 66 7/8	27 5/8 x 31 1/2 x 66 7/8	58 x 31 1/2 x 66 7/8
# of Doors	2	2	4
# of Racks Accepted	1	1	2
# of Shelves	-	-	-
Net Weight (lbs.)	459	459	818
Gross Weight (lbs.)	504	504	876

Design and specifications subject to change without notice. Most updated spec sheets are available at www.turboairinc.com.

Actual shipping weight may differ due to extra packing materials for product protection.

* Depth does not include 2-1/2" for door handles and 6-7/8" for ramps.

■ **WARRANTY: 3 Year Parts and Labor Warranty**

SOLID & HALF DOOR REFRIGERATORS

NATURAL
Refrigerant

Self-Cleaning Condenser Equipped Units

■ **Self-Cleaning Condenser (Patented)**

The accumulation of dust in the condenser can cause the failure or breakdown of refrigerators. Refrigerators run normally until they reach a certain level of accumulation. At some point, when they are over the limit, their performance drops quickly resulting in damage to, or disposal of the stored products inside. The Self-Cleaning Condenser device keeps the condenser clean and prevents system failure by automatically brushing daily.

■ **Digital temperature control & monitor system**

- Keeps food products safe by maintaining constant temperatures
- Alarms that sound when doors are not sealed shut; protects against food spoilage that originates from cold air leaks
- Early warning alarm program detects issues before malfunction occurs
- Digital display allows for easy monitoring
- Programs interpret the condition of refrigeration systems by self-diagnosis
- Rapid cool-down function (Turbo Cooling)
- Automatic evaporator fan motor delays

■ **Hydrocarbon refrigerants (R-290)**

With innovative and eco-friendly technology, Turbo Air brings you hydrocarbon refrigerators designed to meet DOE's Energy Conservation Standards in 2017 and to use EPA's SNAP Program approved HC refrigerants. Hydrocarbon refrigerants do not deplete the ozone layer and have very low contribution to global warming (ODP-0, GWP-3).

■ **Cold air distribution system**

Provides uniformly maintained temperature within the food zone.

■ **Correctional facility - ready features**

Our PRO series CRT units come fully equipped with all the required correctional facilities' features. It includes the stainless steel light cover with security screws, stainless steel PCB cover with security screws, hinges without covers, stainless mesh cover on top, locking hasp (padlock not included), tray slide with security screws and flanged leg.

■ **All stainless steel cabinet construction**

The PRO series model boasts a stainless steel interior and a 22 gauge stainless steel exterior (galvanized steel top, bottom). It guarantees the utmost in cleanliness and long product life. The PRO series model adds a touch of style to the most refined setting.

■ **Sturdy, clean stainless steel shelving**

■ **Hot gas condensate system**

■ **LED interior lighting**

Self-Cleaning Condenser
Maintenance-free
during warranty period



PRO-26R-N-CRT

PRO-50-4R-N-CRT

■ **High-density polyurethane insulation**

The entire cabinet structure and solid doors are foamed-in-place using high density, CFC free polyurethane insulation.

■ **Thermostatic expansion valves**

■ **Refrigerator holds 33°F ~ 38°F for the best in food preservation**

■ **Standard features**

- Top mount compressor
- USB temperature data storage
- Anti-corrosion coated evaporator
- Easily replaceable one-piece magnetic door gaskets
- Self-contained system
- Solid and sturdy grille design
- Door locks
- Lead time applies

■ **Optional features**

- Tray slides available

PRO-R MODELS SPECIFICATIONS

ELECTRICAL DATA	PRO-26R-N-CRT	PRO-50R-N-CRT	PRO-77R-N-CRT	PRO-26-2R-N-CRT	PRO-50-4R-N-CRT
Voltage	115/60/1	115/60/1	115/60/1	115/60/1	115/60/1
Plug Type	Ⓢ NEMA 5-15P	Ⓢ NEMA 5-15P	Ⓢ NEMA 5-15P	Ⓢ NEMA 5-15P	Ⓢ NEMA 5-15P
Full Load Amp.	7.0	8.0	9.0	7.0	8.0
Compressor HP	1/2	1/2	1	1/2	1/2
Cord Length (ft.)	9	9	9	9	9
Refrigerant	R-290	R-290	R-290	R-290	R-290
DIMENSIONAL DATA					
Net Capacity (cu. ft.)	25.41	47.73	75.06	24.76	47.57
Ext. Dimension (L x D ^o x H ^t) (in.)	28 ³ / ₄ x 34 ¹ / ₈ x 78	51 ³ / ₄ x 34 ¹ / ₈ x 78	77 ³ / ₄ x 34 ¹ / ₈ x 78	28 ³ / ₄ x 33 ⁷ / ₈ x 78	51 ³ / ₄ x 33 ⁷ / ₈ x 78
Int. Dimension (L x D x H) (in.)	23 ⁷ / ₈ x 27 ⁵ / ₈ x 58 ³ / ₄	46 ³ / ₄ x 27 ⁵ / ₈ x 58 ³ / ₄	72 ⁷ / ₈ x 27 ⁵ / ₈ x 58 ³ / ₄	23 ⁷ / ₈ x 27 ⁵ / ₈ x 58 ³ / ₄	46 ³ / ₄ x 27 ⁵ / ₈ x 58 ³ / ₄
# of Doors	1	2	3	2	4
# of Racks Accepted	1	2	3	1	2
# of Shelves (Size (L x D) (in.))	3 (23 ¹ / ₂ x 26 ³ / ₈)	6 (22 ³ / ₄ x 26 ³ / ₈ (L/R))	9 (22 ³ / ₄ x 26 ³ / ₈ (L/R), 25 x 26 ³ / ₈ (M))	3 (23 ¹ / ₂ x 26 ³ / ₈)	6 (22 ³ / ₄ x 26 ³ / ₈ (L/R))
Net Weight (lbs.)	315	485	697	315	485
Gross Weight (lbs.)	356	538	765	356	538

Design and specifications subject to change without notice. Most updated spec sheets are available at www.turboairinc.com.

Actual shipping weight may differ due to extra packing materials for product protection.

* Depth does not include 1-1/4" for door handles. † Height does not include 4-3/4" for leg height.

■ **WARRANTY: 5 Year Parts and Labor Warranty, 7 Year Compressor Warranty**

SOLID DOOR FREEZERS NATURAL Refrigerant

Self-Cleaning Condenser Equipped Units

Self-Cleaning Condenser (Patented)

The accumulation of dust in the condenser can cause the failure or breakdown of refrigerators. Refrigerators run normally until they reach a certain level of accumulation. At some point, when they are over the limit, their performance drops quickly resulting in damage to, or disposal of the stored products inside. The Self-Cleaning Condenser device keeps the condenser clean and prevents system failure by automatically brushing daily.

Digital temperature control & monitor system

- Keeps food products safe by maintaining constant temperatures
- Alarms that sound when doors are not sealed shut; protects against food spoilage that originates from cold air leaks
- Early warning alarm program detects issues before malfunction occurs
- Digital display allows for easy monitoring
- Programs interpret the condition of refrigeration systems by self-diagnosis
- Rapid cool-down function (Turbo Freeze)
- Automatic evaporator fan motor delays

Hydrocarbon refrigerants (R-290)

With innovative and eco-friendly technology, Turbo Air brings you hydrocarbon refrigerators designed to meet DOE's Energy Conservation Standards in 2017 and to use EPA's SNAP Program approved HC refrigerants. Hydrocarbon refrigerants do not deplete the ozone layer and have very low contribution to global warming (ODP-0, GWP-3).

Cold air distribution system

Provides uniformly maintained temperature within the food zone.

Correctional facility - ready features

Our PRO series CRT units come fully equipped with all the required correctional facilities' features. It includes the stainless steel light cover with security screws, stainless steel PCB cover with security screws, hinges without covers, stainless mesh cover on top, locking hasp (padlock not included), tray slide with security screws and flanged leg.

All stainless steel cabinet construction

The PRO series model boasts a stainless steel interior and a 22 gauge stainless steel exterior (galvanized steel top, bottom). It guarantees the utmost in cleanliness and long product life. The PRO series model adds a touch of style to the most refined setting.

Sturdy, clean stainless steel shelving

Hot gas condensate system

LED interior lighting

Self-Cleaning Condenser
Maintenance-free
during warranty period



PRO-26F-N-CRT

PRO-50F-N-CRT

High-density polyurethane insulation

The entire cabinet structure and solid doors are foamed-in-place using high density, CFC free polyurethane insulation.

Thermostatic expansion valves

Freezer holds -10°F ~ 0°F for the best in food preservation

Standard features

- Top mount compressor
- USB temperature data storage
- Anti-corrosion coated evaporator
- Easily replaceable one-piece magnetic door gaskets
- Self-contained system
- Solid and sturdy grille design
- Door locks
- Lead time applies

Optional features

- Tray slides available

PRO-F MODELS SPECIFICATIONS

ELECTRICAL DATA	PRO-26F-N-CRT	PRO-50F-N-CRT
Voltage	115/60/1	115/60/1
Plug Type	Ⓜ NEMA 5-15P	Ⓜ NEMA 5-15P
Full Load Amp.	7.0	9.0
Compressor HP	1/2	1
Cord Length (ft.)	9	9
Refrigerant	R-290	R-290
DIMENSIONAL DATA		
Net Capacity (cu. ft.)	25.35	48.36
Ext. Dimension (L x D* x H†) (in.)	28 ³ / ₄ x 34 ¹ / ₈ x 78	51 ³ / ₄ x 34 ¹ / ₈ x 78
Int. Dimension (L x D x H) (in.)	23 ⁷ / ₈ x 27 ⁵ / ₈ x 58 ³ / ₄	46 ³ / ₄ x 27 ⁵ / ₈ x 58 ³ / ₄
# of Doors	1	2
# of Racks Accepted	1	2
# of Shelves (Size (L x D) (in.))	3 (23 ¹ / ₂ x 26 ³ / ₈)	6 (22 ³ / ₄ x 26 ³ / ₈ (L/R))
Net Weight (lbs.)	315	485
Gross Weight (lbs.)	356	538

Design and specifications subject to change without notice. Most updated spec sheets are available at www.turboairinc.com.

Actual shipping weight may differ due to extra packing materials for product protection.

* Depth does not include 1-1/4" for door handles. † Height does not include 4-3/4" for leg height.

WARRANTY: 5 Year Parts and Labor Warranty, 7 Year Compressor Warranty

ROLL-IN SOLID DOOR REFRIGERATORS NATURAL Refrigerant

Self-Cleaning Condenser Equipped Units

■ **Self-Cleaning Condenser (Patented)**

The accumulation of dust in the condenser can cause the failure or breakdown of refrigerators. Refrigerators run normally until they reach a certain level of accumulation. At some point, when they are over the limit, their performance drops quickly resulting in damage to, or disposal of the stored products inside. The Self-Cleaning Condenser device keeps the condenser clean and prevents system failure by automatically brushing daily.

■ **Digital temperature control & monitor system**

- Keeps food products safe by maintaining constant temperatures
- Alarms that sound when doors are not sealed shut; protect against food spoilage that originates from cold air leaks
- Early warning alarm program detects issues before malfunction occurs
- Digital display allows for easy monitoring
- Programs interpret the condition of refrigeration systems by self-diagnosis
- Rapid cool-down function (Turbo Cooling)
- Automatic evaporator fan motor delays

■ **Hydrocarbon refrigerants (R-290)**

With innovative and eco-friendly technology, Turbo Air brings you hydrocarbon refrigerators designed to meet DOE's Energy Conservation Standards in 2017 and to use EPA's SNAP Program approved HC refrigerants. Hydrocarbon refrigerants do not deplete the ozone layer and have very low contribution to global warming (ODP-0, GWP-3).

■ **Cold air distribution system**

Provides uniformly maintained temperature within the food zone.

■ **Correctional facility - ready features**

Our PRO series CRT units come fully equipped with all the required correctional facilities' features. It includes the stainless steel light cover with security screws, stainless steel PCB cover with security screws, hinges without covers, stainless mesh cover on top, locking hasp (padlock not included), tray slide with security screws.

■ **All stainless steel cabinet construction**

The PRO series model boasts a stainless steel interior and a 22 gauge stainless steel exterior (galvanized steel top, bottom). It guarantees the utmost in cleanliness and long product life. The PRO series model adds a touch of style to the most refined setting.

■ **LED interior lighting**

■ **High-density polyurethane insulation**

The entire cabinet structure and solid doors are foamed-in-place using high density, CFC free polyurethane insulation.

Self-Cleaning Condenser
Maintenance-free
during warranty period



PRO-50R-RI-N-CRT

■ **Hot gas condensate system**

■ **Thermostatic expansion valves**

■ **Refrigerator holds 33°F ~ 38°F for the best in food preservation**

■ **Standard features**

- Top mount compressor
- Anti-corrosion coated evaporator
- USB temperature data storage
- Door locks
- Self-contained system
- Solid and sturdy grille design
- Heavy duty stainless steel ramp
- Lead time applies

PRO-R-RI-CRT MODELS SPECIFICATIONS

ELECTRICAL DATA	PRO-26R-RI-N-CRT	PRO-50R-RI-N-CRT
Voltage	115/60/1	115/60/1
Plug Type	Ⓢ NEMA 5-15P	Ⓢ NEMA 5-15P
Full Load Amp.	7.0	8.0
Compressor HP	1/2	1
Cord Length (ft.)	9	9
Refrigerant	R-290	R-290
DIMENSIONAL DATA		
Net Capacity (cu. ft.)	39.32	81.87
Ext. Dimension (L x D* x H) (in.)	34 x 37 ³ / ₄ x 84 ¹ / ₄	66 ⁷ / ₈ x 37 ³ / ₄ x 84 ¹ / ₄
Int. Dimension (L x D x H) (in.)	29 ¹ / ₈ x 31 ¹ / ₂ x 66 ⁷ / ₈	62 x 31 ¹ / ₂ x 66 ⁷ / ₈
# of Doors	1	2
# of Racks Accepted	1	2
# of Shelves	-	-
Net Weight (lbs.)	410	668
Gross Weight (lbs.)	510	820

Design and specifications subject to change without notice. Most updated spec sheets are available at www.turboairinc.com.

Actual shipping weight may differ due to extra packing materials for product protection.

* Depth does not include 1-1/4" for door handles and 3-1/2" for ramps.

■ **WARRANTY: 5 Year Parts and Labor Warranty, 7 Year Compressor Warranty**

SOLID DOOR HEATED CABINETS

■ **Digital temperature control & monitor system**

- Keeps food products safe by maintaining constant temperatures
- Alarm beeps when doors are not sealed
- Early warning alarm program detects issues before malfunction occurs
- Digital display allows for easy monitoring
- Sensitive touch display

■ **Ducted fan air distribution system**

Maintains temperature within the food zone.

■ **On/Off switch**

ON/OFF switch is located on control panel

■ **All stainless steel cabinet construction**

The PRO series model boasts a stainless steel interior and a 22 gauge stainless steel exterior (galvanized steel top, bottom). It guarantees the utmost in cleanliness and long product life. The PRO series model adds a touch of style to the most refined setting.

■ **Sturdy, clean stainless steel shelving**

Only the Turbo Air PRO series uniquely provides stainless steel shelving. Shelves are the most important part of cleanliness as they come in direct contact with food. After a while, PVC coated wire shelves may peel, rust and lead to unsanitary conditions.

■ **LED interior lighting**

■ **High-density polyurethane insulation**

Structure and solid doors are foamed-in-place using high density, CFC free polyurethane insulation.

■ **Full length stainless steel doors with locks**

■ **Self-closing doors with stay open feature at 120 degrees**

■ **Heated cabinet holds 140°F ~ 180°F for the best in food preservation**

■ **Correctional facility - ready features**

Our PRO series CRT units come fully equipped with all the required correctional facilities' features. It includes the stainless steel light cover with security screws, stainless steel PCB cover with security screws, hinges without covers, stainless mesh cover on top, locking hasp (padlock not included), tray slide with security screws and flanged leg.



PRO-77H-CRT

PRO-50H-CRT

■ **Standard features**

- Door locks
- Easy replaceable one piece magnetic door gaskets
- Solid and sturdy grille design
- Lead time applies

■ **Optional features**

- Tray slides available

PRO-H-CRT MODELS SPECIFICATIONS

ELECTRICAL DATA	PRO-26H-CRT	PRO-50H-CRT	PRO-77H-CRT
Voltage	115/60/1	208/115/60/1	208/115/60/1
Plug Type	Ⓢ NEMA L14-20P	Ⓢ NEMA L14-20P	Ⓢ NEMA 5-15P
Full Load Amp.	13.5	15	15
Wattage (W)	1550	3000	3000
Cord Length (ft.)	8	8	8
DIMENSIONAL DATA			
Net Capacity (cu. ft.)	25.0	48.0	73.0
Ext. Dimension (L x D* x H†) (in.)	28 ³ / ₄ x 33 ⁷ / ₈ x 78	51 ³ / ₄ x 33 ⁷ / ₈ x 78	77 ³ / ₄ x 33 ⁷ / ₈ x 78
Int. Dimension (L x D x H) (in.)	22 x 27 ⁵ / ₈ x 58 ³ / ₄	42 ¹ / ₄ x 27 ⁵ / ₈ x 58 ³ / ₄	68 ¹ / ₄ x 27 ⁵ / ₈ x 58 ³ / ₄
# of Doors	1	2	3
# of Racks Accepted	1	2	3
# of Shelves (Size (L x D) (in.))	3 (23 ¹ / ₂ x 26 ³ / ₈)	6 (22 ³ / ₄ x 26 ³ / ₈ (L/R))	9 (22 ³ / ₄ x 26 ³ / ₈ (L/R), 25 x 26 ³ / ₈ (M))
Net Weight (lbs.)	259	404	700
Gross Weight (lbs.)	304	462	768

Design and specifications subject to change without notice. Most updated spec sheets are available at www.turboairinc.com.

Actual shipping weight may differ due to extra packing materials for product protection.

* Depth does not include 1-1/4" for door handles. † Height does not include 4-3/4" for leg height.

■ **WARRANTY: 3 Year Parts and Labor Warranty**

ROLL-IN SOLID DOOR HEATED CABINETS

■ **Digital temperature control & monitor system**

- Keeps food products safe by maintaining constant temperatures
- Alarm beeps when doors are not sealed
- Early warning alarm program detects issues before malfunction occurs
- Digital display allows for easy monitoring
- Sensitive touch display

■ **Ducted fan air distribution system**

Maintains temperature within the food zone.

■ **On/Off switch**

ON/OFF switch is located on control panel

■ **All stainless steel cabinet construction**

The PRO series model boasts a stainless steel interior and a 22 gauge stainless steel exterior (galvanized steel top, bottom). It guarantees the utmost in cleanliness and long product life. The PRO series model adds a touch of style to the most refined setting.

■ **Sturdy, clean stainless steel shelving**

Only the Turbo Air PRO series uniquely provides stainless steel shelving. Shelves are the most important part of cleanliness as they come in direct contact with food. After a while, PVC coated wire shelves may peel, rust and lead to unsanitary conditions.

■ **LED interior lighting**

■ **High-density polyurethane insulation**

Structure and solid doors are foamed-in-place using high density, CFC free polyurethane insulation.

■ **Full length stainless steel doors with lock**

■ **Self-closing doors with stay open feature at 120 degrees**

■ **Heated cabinet holds 140°F ~ 180°F for the best in food preservation**

■ **Correctional facility - ready features**

Our PRO series CRT units come fully equipped with all the required correctional facilities' features. It includes the stainless steel light cover with security screws, stainless steel PCB cover with security screws, hinges without covers, stainless mesh cover on top, locking hasp (padlock not included), tray slide with security screws.



PRO-50H-RI-CRT

■ **Standard features**

- Door locks
- Easy replaceable one piece magnetic door gaskets
- Solid and sturdy grille design
- Lead time applies

PRO-H-RI-CRT MODELS SPECIFICATIONS

ELECTRICAL DATA	PRO-50H-RI-CRT
Voltage	208/115/60/1
Plug Type	Ⓢ NEMA L14-20P
Full Load Amp.	15
Wattage (W)	3000
Cord Length (ft.)	8
DIMENSIONAL DATA	
Net Capacity (cu. ft.)	75.6
Ext. Dimension (L x D ^o x H) (in.)	66 ⁷ / ₈ x 37 ³ / ₄ x 84 ¹ / ₄
Int. Dimension (L x D x H) (in.)	57 ³ / ₈ x 31 ¹ / ₂ x 66 ⁷ / ₈
# of Doors	2
# of Racks Accepted	2
# of Shelves	-
Net Weight (lbs.)	758
Gross Weight (lbs.)	816

Design and specifications subject to change without notice. Most updated spec sheets are available at www.turboairinc.com.

Actual shipping weight may differ due to extra packing materials for product protection.

* Depth does not include 1-1/4" for door handles and 3-1/2" for ramps.

■ **WARRANTY: 3 Year Parts and Labor Warranty**

SOLID & GLASS DOOR PROOFERS

■ **Digital temperature control & monitor system**

- Keeps constant proofing temperature with less variation
- Alarm beeps when doors are not sealed
- Digital display allows for easy monitoring and control
- Sensitive touch display

■ **Ducted fan air distribution system for even proofing**

- Maintains temperature within the food zone
- Proofing evenly top to bottom with less temperature variation

■ **On/Off switch**

ON/OFF switch is located on control panel

■ **All stainless steel cabinet construction**

The PRO series model boasts a stainless steel interior and a 22 gauge stainless steel exterior (galvanized steel top, bottom). It guarantees the utmost in cleanliness and long product life. The PRO series model adds a touch of style to the most refined setting.

■ **Sturdy, clean stainless steel shelving**

Shelves are the most important part of cleanliness as they come in direct contact with food. After a while, PVC coated wire shelves may peel, rust and lead to unsanitary conditions. Only the Turbo Air PRO series uniquely provides stainless steel shelving.

■ **LED interior lighting**

■ **High-density polyurethane insulation**

The entire cabinet structure and solid doors are foamed-in-place using high density, CFC free polyurethane insulation.

■ **Full length stainless steel solid doors with locks**

■ **Self-closing doors with stay open feature at 120 degrees**

■ **Proofing temperature 70°F ~ 115°F and proofing timer 30min ~ 150min for precise control**

■ **Lifetime guaranteed heavy duty hinges and handles**



PRO-26H-PF



PRO-26H2-G-PF

■ **Left hinged (PRO-26H-PF-L, PRO-26H2-G-PF-L) models available**

■ **Standard features**

- Door locks
- 4" dia. swivel casters with locks on the front set
- Easy replaceable one piece magnetic door gaskets
- Solid and sturdy grille design

■ **Optional features**

- Legs available for all models
- Tray slides available

PRO-H-PF/G-PF MODELS SPECIFICATIONS

ELECTRICAL DATA	PRO-26H-PF	PRO-26H2-PF	PRO-26H2-G-PF
Voltage	115/60/1	208/115/60/1	208/115/60/1
Plug Type	Ⓜ NEMA 5-15P	Ⓜ NEMA L14-20P	Ⓜ NEMA L14-20P
Full Load Amp.	13.5	7.5	7.5
Wattage (W)	1550	1550	3000
Cord Length (ft.)	8	8	8
DIMENSIONAL DATA			
Net Capacity (cu. ft.)	25.0	25.0	25.0
Ext. Dimension (L x D [†] x H [†]) (in.)	28 ³ / ₄ x 33 ⁷ / ₈ x 78	28 ³ / ₄ x 33 ⁷ / ₈ x 78	28 ³ / ₄ x 34 ¹ / ₈ x 78
Int. Dimension (L x D x H) (in.)	22 x 27 ⁵ / ₈ x 58 ³ / ₄	22 x 27 ⁵ / ₈ x 58 ³ / ₄	23 ⁷ / ₈ x 27 ¹ / ₂ x 59 ¹ / ₄
# of Doors	1	1	1
# of Racks Accepted	1	1	1
# of Shelves (Size (L x D) (in.))	3 (23 ¹ / ₂ x 26 ³ / ₈)	3 (23 ¹ / ₂ x 26 ³ / ₈)	3 (23 ¹ / ₂ x 26 ³ / ₈)
Net Weight (lbs.)	259	259	269
Gross Weight (lbs.)	304	304	314

Design and specifications subject to change without notice. Most updated spec sheets are available at www.turboairinc.com.

Actual shipping weight may differ due to extra packing materials for product protection.

* Depth does not include 1-1/4" for door handles. † Height does not include 5" for caster height.

■ **WARRANTY: 3 Year Parts and Labor Warranty**

ROLL-IN SOLID DOOR PROOFERS

■ **Digital temperature control & monitor system**

- Keeps constant proofing temperature with less variation
- Alarm beeps when doors are not sealed
- Digital display allows for easy monitoring and control
- Sensitive touch display

■ **Ducted fan air distribution system for even proofing**

- Maintains temperature within the food zone
- Proofing evenly top to bottom with less temperature variation

■ **On/Off switch**

ON/OFF switch is located on control panel

■ **All stainless steel cabinet construction**

The PRO series model boasts a stainless steel interior and a **22 gauge** stainless steel exterior (galvanized steel top, bottom). It guarantees the utmost in cleanliness and long product life. The PRO series model adds a touch of style to the most refined setting.

■ **LED interior lighting**

■ **High-density polyurethane insulation**

The entire cabinet structure and solid doors are foamed-in-place using high density, CFC free polyurethane insulation.

■ **Full length stainless steel solid doors with locks**

■ **Self-closing doors with stay open feature at 120 degrees**

■ **Proofing temperature 70°F ~ 115°F and proofing timer 30min ~ 150min for precise control**

■ **Lifetime guaranteed heavy duty hinges and handles**

■ **Left hinged (PRO-26H-RI-PF-L, PRO-26H2-RI-PF-L) models available**



PRO-26H-RI-PF

PRO-50H-RI-PF

■ **Standard features**

- Door locks
- Solid and sturdy grille design
- Heavy duty stainless steel ramp

PRO-H-RI-PF MODELS SPECIFICATIONS

ELECTRICAL DATA	PRO-26H-RI-PF	PRO-26H2-RI-PF	PRO-50H-RI-PF
Voltage	115/60/1	208/115/60/1	208/115/60/1
Plug Type	Ⓢ NEMA 5-15P	Ⓢ NEMA L14-20P	Ⓢ NEMA L14-20P
Full Load Amp.	13.5	7.5	15
Wattage (W)	1550	1550	3000
Cord Length (ft.)	8	8	8
DIMENSIONAL DATA			
Net Capacity (cu. ft.)	35.51	35.51	75.59
Ext. Dimension (L x D x H) (in.)	34 x 37 ³ / ₄ x 84 ¹ / ₄	34 x 37 ³ / ₄ x 84 ¹ / ₄	66 ⁷ / ₈ x 37 ³ / ₄ x 84 ¹ / ₄
Int. Dimension (L x D x H) (in.)	27 ³ / ₈ x 31 x 66 ⁷ / ₈	27 ³ / ₈ x 31 x 66 ⁷ / ₈	60 ³ / ₄ x 32 ¹ / ₄ x 68 ³ / ₈
# of Doors	1	1	2
# of Racks Accepted (L x D x H) (in.)	1 (27 x 29 x 66)	1 (27 x 29 x 66)	2 (27 x 29 x 66)
Net Weight (lbs.)	391	391	641
Gross Weight (lbs.)	436	436	699

Design and specifications subject to change without notice. Most updated spec sheets are available at www.turboairinc.com.

Actual shipping weight may differ due to extra packing materials for product protection.

* Depth does not include 1-1/4" for door handles and 3-1/2" for ramps.

■ **WARRANTY: 3 Year Parts and Labor Warranty**

SOLID DOOR REFRIGERATORS NATURAL Refrigerant

Self-Cleaning Condenser Equipped Units

Self-Cleaning Condenser (Patented)

The accumulation of dust in the condenser can cause the failure or breakdown of refrigerators. Refrigerators run normally until they reach a certain level of accumulation. At some point, when they are over the limit, their performance drops quickly resulting in damage to, or disposal of the stored products inside. The Self-Cleaning Condenser device keeps the condenser clean and prevents system failure by automatically brushing daily.

Digital temperature control & monitor system

- Keeps food products safe by maintaining constant temperatures
- Alarms that sound when doors are not sealed shut; protects against food spoilage that originates from cold air leaks
- Early warning alarm program detects issues before malfunction occurs
- Digital display allows for easy monitoring
- Programs interpret the condition of refrigeration systems by self-diagnosis
- Rapid cool-down function (Turbo Cooling)
- Automatic evaporator fan motor delays

Hydrocarbon refrigerants (R-290 / R-600a)

With innovative and eco-friendly technology, Turbo Air brings you hydrocarbon refrigerators designed to meet DOE's Energy Conservation Standards in 2017 and to use EPA's SNAP Program approved HC refrigerants. Hydrocarbon refrigerants do not deplete the ozone layer and have very low contribution to global warming (ODP-0, GWP-3).

Stainless steel cabinet construction

The Turbo Air Super Deluxe model boasts a stainless steel interior and exterior (galvanized steel top, bottom and back). It guarantees the utmost in cleanliness and long product life. Sharp corners and edges have been rounded to reduce the risk of injury. The Super Deluxe adds a touch of style to the most refined setting.

Sturdy, clean stainless steel shelving

Shelves are the most important part of cleanliness as they come in direct contact with food. After a while, PVC coated wire shelves may peel, rust and lead to unsanitary conditions. Only the Turbo Air Super Deluxe series uniquely provides stainless steel shelving.

Left hinged model available (TSR-23SD-N6-L)

LED interior lighting

Bottom mount compressor

Refrigerator holds 33°F ~ 38°F for the best in food preservation



Self-Cleaning Condenser
Maintenance-free during warranty period

TSR-72SD-N

TSR-23SD-N6

Door pressure release device (Patented)

Pressure relief doors are designed to eliminate vacuum pressure and allow easy door opening.

Standard features

- Anti-corrosion coated evaporator
- Positive seal self-closing doors
- Easily replaceable one-piece magnetic door gaskets
- Self-contained system
- Solid and sturdy grille design
- High-density polyurethane insulation
- Door locks
- 4" dia. swivel casters with locks on the front set

Optional features

- Legs available for all models
- Full and half pan racks available (except TSR-35SD-N6)

TSR MODELS SPECIFICATIONS

ELECTRICAL DATA	TSR-23SD-N6	TSR-35SD-N6	TSR-49SD-N6	TSR-72SD-N
Voltage	115/60/1	115/60/1	115/60/1	115/60/1
Plug Type	Ⓜ NEMA 5-15P	Ⓜ NEMA 5-15P	Ⓜ NEMA 5-15P	Ⓜ NEMA 5-15P
Full Load Amp.	1.5	1.9	2.3	5.7
Compressor HP	1/8	1/5	1/5	1/2
Cord Length (ft.)	7	7	7	7
Refrigerant	R-600a	R-600a	R-600a	R-290
DIMENSIONAL DATA				
Net Capacity (cu. ft.)	19.30	29.19	42.69	64.1
Ext. Dimension (L x D x H†) (in.)	27 x 30 ³ / ₈ x 78 ¹ / ₄	39 ¹ / ₂ x 30 ³ / ₈ x 78 ¹ / ₄	54 ¹ / ₂ x 30 ³ / ₈ x 78 ¹ / ₄	81 ⁷ / ₈ x 30 ³ / ₈ x 78 ¹ / ₄
# of Doors	1	2	2	3
# of Racks Accepted	1	-	2	3
# of Shelves (Size (L x D) (in.))	3 (22 x 23 ¹ / ₂)	6 (17 ¹ / ₄ x 23 ¹ / ₂)	6 (24 ¹ / ₂ x 23 ¹ / ₂)	9 (24 ¹ / ₂ x 23 ¹ / ₂)
Net Weight (lbs.)	261	339	404	586
Gross Weight (lbs.)	274	357	427	612

Design and specifications subject to change without notice. Most updated spec sheets are available at www.turboairinc.com.

Actual shipping weight may differ due to extra packing materials for product protection.

† Height does not include 5" for caster height.

WARRANTY: 5 Year Parts and Labor Warranty, 7 Year Compressor Warranty

SOLID DOOR FREEZERS NATURAL Refrigerant

Self-Cleaning Condenser Equipped Units

■ **Self-Cleaning Condenser (Patented)**

The accumulation of dust in the condenser can cause the failure or breakdown of refrigerators. Refrigerators run normally until they reach a certain level of accumulation. At some point, when they are over the limit, their performance drops quickly resulting in damage to, or disposal of the stored products inside. The Self-Cleaning Condenser device keeps the condenser clean and prevents system failure by automatically brushing daily.

■ **Digital temperature control & monitor system**

- Keeps food products safe by maintaining constant temperatures
- Alarms that sound when doors are not sealed shut; protects against food spoilage that originates from cold air leaks
- Early warning alarm program detects issues before malfunction occurs
- Digital display allows for easy monitoring
- Programs interpret the condition of refrigeration systems by self-diagnosis
- Rapid cool-down function (Turbo Freeze)
- Smart defrost system will defrost as needed
- Automatic evaporator fan motor delays

■ **Hydrocarbon refrigerants (R-290)**

With innovative and eco-friendly technology, Turbo Air brings you hydrocarbon refrigerators designed to meet DOE's Energy Conservation Standards in 2017 and to use EPA's SNAP Program approved HC refrigerants. Hydrocarbon refrigerants do not deplete the ozone layer and have very low contribution to global warming (ODP-0, GWP-3).

■ **Stainless steel cabinet construction**

The Turbo Air Super Deluxe model boasts a stainless steel interior and exterior (galvanized steel top, bottom and back). It guarantees the utmost in cleanliness and long product life. Sharp corners and edges have been rounded to reduce the risk of injury. The Super Deluxe adds a touch of style to the most refined setting.

■ **Sturdy, clean stainless steel shelving**

Shelves are the most important part of cleanliness as they come in direct contact with food. After a while, PVC coated wire shelves may peel, rust and lead to unsanitary conditions. Only the Turbo Air Super Deluxe series uniquely provides stainless steel shelving.

■ **High-density polyurethane insulation**

The entire cabinet structure and solid doors are foamed-in-place using high density, HCFC free polyurethane insulation.

■ **Left hinged model available (TSF-23SD-N-L)**

■ **LED interior lighting**

■ **Bottom mount compressor**



Self-Cleaning Condenser
Maintenance-free
during warranty period

TSF-49SD-N

TSF-23SD-N

■ **Door pressure release device (Patented)**

Pressure relief doors are designed to eliminate vacuum pressure and allow easy door opening.

■ **Freezer holds -10°F ~ 0°F for the best in frozen food preservation**

■ **Standard features**

- Anti-corrosion coated evaporator
- Positive seal self-closing doors
- Easily replaceable one-piece magnetic door gaskets
- Self-contained system
- Solid and sturdy grille design
- Door locks
- 4" dia. swivel casters with locks on the front set

■ **Optional features**

- Legs available for all models
- Full and half pan racks available (except TSF-35SDN-N)

TSF MODELS SPECIFICATIONS

ELECTRICAL DATA	TSF-23SD-N	TSF-35SDN-N	TSF-49SD-N	TSF-72SD-N
Voltage	115/60/1	115/60/1	115/60/1	115/60/1
Plug Type	Ⓜ NEMA 5-15P	Ⓜ NEMA 5-15P	Ⓜ NEMA 5-15P	Ⓜ NEMA 5-15P
Full Load Amp.	4.8	5.1	5.5	6.5
Compressor HP	1/2	1/2	2/3	3/4
Cord Length (ft.)	7	7	7	7
Refrigerant	R-290	R-290	R-290	R-290
DIMENSIONAL DATA				
Net Capacity (cu. ft.)	19.03	29.19	39.9	63.8
Ext. Dimension (L x D x HT) (in.)	27 x 30 ³ / ₈ x 78 ¹ / ₄	39 ¹ / ₂ x 30 ³ / ₈ x 78 ¹ / ₄	54 ¹ / ₂ x 30 ³ / ₈ x 78 ¹ / ₄	81 ⁷ / ₈ x 30 ³ / ₈ x 78 ¹ / ₄
# of Doors	1	2	2	3
# of Racks Accepted	1	-	2	3
# of Shelves (Size (L x D) (in.))	3 (22 x 23 ¹ / ₂)	6 (17 ¹ / ₄ x 23 ¹ / ₂)	6 (24 ¹ / ₂ x 23 ¹ / ₂)	9 (24 ¹ / ₂ x 23 ¹ / ₂)
Net Weight (lbs.)	280	360	434	624
Gross Weight (lbs.)	293	378	457	650

Design and specifications subject to change without notice. Most updated spec sheets are available at www.turboairinc.com.

Actual shipping weight may differ due to extra packing materials for product protection.

† Height does not include 5" for caster height.

■ **WARRANTY: 5 Year Parts and Labor Warranty, 7 Year Compressor Warranty**

GLASS DOOR REFRIGERATORS NATURAL Refrigerant

Self-Cleaning Condenser Equipped Units

■ **Self-Cleaning Condenser (Patented)**

The accumulation of dust in the condenser can cause the failure or breakdown of refrigerators. Refrigerators run normally until they reach a certain level of accumulation. At some point, when they are over the limit, their performance drops quickly resulting in damage to, or disposal of the stored products inside. The Self-Cleaning Condenser device keeps the condenser clean and prevents system failure by automatically brushing daily.

■ **Digital temperature control & monitor system**

- Keeps food products safe by maintaining constant temperatures
- Alarms that sound when doors are not sealed shut; protects against food spoilage that originates from cold air leaks
- Early warning alarm program detects issues before malfunction occurs
- Digital display allows for easy monitoring
- Programs interpret the condition of refrigeration systems by self-diagnosis
- Rapid cool-down functions (Turbo Cooling)
- Automatic evaporator fan motor delays

■ **Hydrocarbon refrigerants (R-290 / R-600a)**

With innovative and eco-friendly technology, Turbo Air brings you hydrocarbon refrigerators designed to meet DOE's Energy Conservation Standards in 2017 and to use EPA's SNAP Program approved HC refrigerants. Hydrocarbon refrigerants do not deplete the ozone layer and have very low contribution to global warming (ODP-0, GWP-3).

■ **Stainless steel interior & exterior**

The Turbo Air Super Deluxe glass door model is constructed with stainless steel exterior. The door is glass with AL frame. The interior is stainless steel that guarantees the utmost in cleanliness and long product life. The Super Deluxe adds a touch of style to the most refined setting.

■ **Double pane glass doors with Low-E glass**

Energy saving double pane glass doors are equipped with Low-emissivity glass, which reduces outer heat gain and decreases energy consumption. It enhances energy efficiency and minimizes condensation. Lightweight door construction also reduces door maintenance and bushing wear, which in turn facilitates smoother door opening.

■ **Ergonomically designed doors**

Customers' fatigue fades away with easy grip handles and doors that open effortlessly. Self-closing features make this the ultimate choice in customer convenience.

■ **Adjustable, heavy duty, PE (polyethylene) coated wire shelves**

■ **LED interior lighting**

■ **Bottom mount compressor**



TSR-72GSD-N

Self-Cleaning Condenser
Maintenance-free during warranty period

TSR-49GSD-N

■ **Door pressure release device (Patented)**

Pressure relief doors are designed to eliminate vacuum pressure and allow easy door opening.

■ **Refrigerator holds 33°F ~ 38°F for the best in food preservation**

■ **Standard features**

- Anti-corrosion coated evaporator
- Easily replaceable one-piece magnetic door gaskets
- Self-contained system
- Solid and sturdy grille design
- Door locks
- 4" dia. swivel casters with locks on the front set
- High-density polyurethane insulation

■ **Optional features**

- Legs available for all models

TSR-G MODELS SPECIFICATIONS

ELECTRICAL DATA	TSR-23GSD-N6	TSR-35GSD-N	TSR-49GSD-N	TSR-72GSD-N
Voltage	115/60/1	115/60/1	115/60/1	115/60/1
Plug Type	Ⓢ NEMA 5-15P	Ⓢ NEMA 5-15P	Ⓢ NEMA 5-15P	Ⓢ NEMA 5-15P
Full Load Amp.	1.6	3.1	3.1	7.5
Compressor HP	1/5	1/3	1/3	1/2
Cord Length (ft.)	7	7	7	7
Refrigerant	R-600a	R-290	R-290	R-290
DIMENSIONAL DATA				
Net Capacity (cu. ft.)	20	27.50	44.14	67.02
Ext. Dimension (L x D ^x x H [†]) (in.)	27 x 30 ³ / ₈ x 78 ¹ / ₄	39 ¹ / ₂ x 30 ³ / ₈ x 78 ¹ / ₄	54 ¹ / ₂ x 30 ³ / ₈ x 78 ¹ / ₄	81 ⁷ / ₈ x 30 ³ / ₈ x 78 ¹ / ₄
# of Doors	1	2	2	3
# of Racks Accepted	1	-	2	3
# of Shelves (Size (L x D) (in.))	3 (22 x 23 ¹ / ₂)	6 (16 ⁷ / ₈ x 23 ¹ / ₄)	6 (24 ⁵ / ₈ x 23 ¹ / ₂)	9 (24 ⁵ / ₈ x 23 ¹ / ₂ (L/R), 25 x 23 ¹ / ₂ (M))
Net Weight (lbs.)	297	382	457	654
Gross Weight (lbs.)	310	400	480	680

Design and specifications subject to change without notice. Most updated spec sheets are available at www.turboairinc.com.

Actual shipping weight may differ due to extra packing materials for product protection.

* Depth does not include 1-1/2" for door handles. † Height does not include 5" for caster height.

■ **WARRANTY: 5 Year Parts and Labor Warranty, 7 Year Compressor Warranty**

GLASS DOOR FREEZERS NATURAL Refrigerant

Self-Cleaning Condenser Equipped Units

Self-Cleaning Condenser (Patented)

The accumulation of dust in the condenser can cause the failure or breakdown of refrigerators. Refrigerators run normally until they reach a certain level of accumulation. At some point, when they are over the limit, their performance drops quickly resulting in damage to, or disposal of the stored products inside. The Self-Cleaning Condenser device keeps the condenser clean and prevents system failure by automatically brushing daily.

Digital temperature control & monitor system

- Keeps food products safe by maintaining constant temperatures
- Alarms that sound when doors are not sealed shut; protects against food spoilage that originates from cold air leaks
- Early warning alarm program detects issues before malfunction occurs
- Digital display allows for easy monitoring
- Programs interpret the condition of refrigeration systems by self-diagnosis
- Rapid cool-down functions (Turbo Freeze)
- Automatic evaporator fan motor delays
- Smart defrost system will defrost as needed

Hydrocarbon refrigerants (R-290)

With innovative and eco-friendly technology, Turbo Air brings you hydrocarbon refrigerators designed to meet DOE's Energy Conservation Standards in 2017 and to use EPA's SNAP Program approved HC refrigerants. Hydrocarbon refrigerants do not deplete the ozone layer and have very low contribution to global warming (ODP-0, GWP-3).

Stainless steel interior & exterior

The Turbo Air Super Deluxe glass door model is constructed with stainless steel exterior. The door is glass with AL frame. The interior is stainless steel that guarantees the utmost in cleanliness and long product life. The Super Deluxe adds a touch of style to the most refined setting.

Double pane glass doors with Low-E glass

Energy saving double pane glass doors are equipped with Low-emissivity glass, which reduces outer heat gain and decreases energy consumption. It enhances energy efficiency and minimizes condensation. Lightweight door construction also reduces door maintenance and bushing wear, which in turn facilitates smoother door opening.

Ergonomically designed doors

Customers' fatigue fades away with easy grip handles and doors that open effortlessly. Self-closing features make this the ultimate choice in customer convenience.

Adjustable, heavy duty, PE (polyethylene) coated wire shelves

LED interior lighting

Bottom mount compressor



TSF-23GSD-N

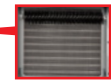

Self-Cleaning Condenser
Maintenance-free during warranty period

Door pressure release device (Patented)

Pressure relief doors are designed to eliminate vacuum pressure and allow easy door opening.

Freezer holds -10°F ~ 0°F for the best in frozen food preservation

Standard features

- Anti-corrosion coated evaporator
- Easily replaceable one-piece magnetic door gaskets
- Self-contained system
- Solid and sturdy grille design
- Door locks
- 4" dia. swivel casters with locks on the front set
- High-density polyurethane insulation

Optional features

- Legs available for all models

TSF-G MODELS SPECIFICATIONS

ELECTRICAL DATA		TSF-23GSD-N
Voltage		115/60/1
Plug Type		Ⓜ NEMA 5-15P
Full Load Amp.		5.4
Compressor HP		1/2
Cord Length (ft.)		7
Refrigerant		R-290
DIMENSIONAL DATA		
Net Capacity (cu. ft.)		19.13
Ext. Dimension (L x D [†] x H [†]) (in.)		27 x 30 ^{3/8} x 78 ^{1/4}
# of Doors		1
# of Racks Accepted		-
# of Shelves (Size (L x D) (in.))		3 (22 x 23 ^{1/2})
Net Weight (lbs.)		297
Gross Weight (lbs.)		310

Design and specifications subject to change without notice. Most updated spec sheets are available at www.turboairinc.com.

Actual shipping weight may differ due to extra packing materials for product protection.

* Depth does not include 1-1/2" for door handles. † Height does not include 5" for caster height.

WARRANTY: 5 Year Parts and Labor Warranty, 7 Year Compressor Warranty

SOLID DOOR REFRIGERATORS NATURAL Refrigerant

Self-Cleaning Condenser Equipped Units

■ **Self-Cleaning Condenser (Patented)**

The accumulation of dust in the condenser can cause the failure or breakdown of refrigerators. Refrigerators run normally until they reach a certain level of accumulation. At some point, when they are over the limit, their performance drops quickly resulting in damage to, or disposal of the stored products inside. The Self-Cleaning Condenser device keeps the condenser clean and prevents system failure by automatically brushing daily.

■ **Digital temperature control & monitor system**

- Keeps food products safe by maintaining constant temperatures
- Alarms that sound when doors are not sealed shut; protects against food spoilage that originates from cold air leaks
- Early warning alarm program detects issues before malfunction occurs
- Digital display allows for easy monitoring
- Programs interpret the condition of refrigeration systems by self-diagnosis
- Rapid cool-down function (Turbo Cooling)
- Automatic evaporator fan motor delays

■ **Hydrocarbon refrigerants (R-290 / R-600a)**

With innovative and eco-friendly technology, Turbo Air brings you hydrocarbon refrigerators designed to meet DOE's Energy Conservation Standards in 2017 and to use EPA's SNAP Program approved HC refrigerants. Hydrocarbon refrigerants do not deplete the ozone layer and have very low contribution to global warming (ODP-0, GWP-3).

■ **Hot gas condensate system**

Through Turbo Air's creative innovation, the condensate system surfaces have been specially treated to resist corrosion. This not only increases efficiency without the risk of refrigerant leakage from corrosion, but also thoroughly prevents the overflow of condensate water.

■ **Stainless steel exterior**

The Turbo Air M3 refrigerator model boasts a stainless steel exterior (galvanized steel top, bottom and back) and AL interior with stainless steel floor. It guarantees the utmost in cleanliness and long product life. Sharp corners and edges have been rounded to reduce the risk of injury. The M3 adds a touch of style to the most refined setting.

■ **Field reversible door hinge (M3R19-1-N6, M3R24-1-N), all left hinged (M3R72-3-N-AL), all right hinged (M3R72-3-N-AR) models available**

■ **LED interior lighting**

■ **Adjustable, heavy duty, PE (polyethylene) coated wire shelves**

■ **Top mount compressor**

Self-Cleaning Condenser
Maintenance-free
during warranty period



M3R72-3-N

M3R24-1-N

■ **Door pressure release device (Patented)**

Pressure relief doors are designed to eliminate vacuum pressure and allow easy door opening.

■ **Refrigerator holds 33°F ~ 38°F for the best in food preservation**

■ **Standard features**

- Anti-corrosion coated evaporator
- Self-contained system
- 4" dia. swivel casters with locks on the front set
- Door locks
- Solid and sturdy grille design
- High-density polyurethane insulation

■ **Optional features**

- Legs available for all models
- Full and half pan racks available (except M3R19-1-N6)

M3R MODELS SPECIFICATIONS

ELECTRICAL DATA	M3R19-1-N6	M3R24-1-N	M3R47-2-N	M3R72-3-N
Voltage	115/60/1	115/60/1	115/60/1	115/60/1
Plug Type	Ⓢ NEMA 5-15P	Ⓢ NEMA 5-15P	Ⓢ NEMA 5-15P	Ⓢ NEMA 5-15P
Full Load Amp.	1.7	2.5	2.8	5.6
Compressor HP	1/5	1/4+	1/3+	1/2
Cord Length (ft.)	9	9	9	9
Refrigerant	R-600a	R-290	R-290	R-290
DIMENSIONAL DATA				
Net Capacity (cu. ft.)	18.44	21.6	42.3	65.8
Ext. Dimension (L x D x H†) (in.)	25 1/4 x 31 1/2 x 72	28 3/4 x 30 3/4 x 77 7/8	51 3/4 x 30 3/4 x 77 7/8	77 3/4 x 30 3/4 x 77 7/8
# of Doors	1	1	2	3
# of Racks Accepted	-	1	2	3
# of Shelves (Size (L x D) (in.))	3 (20 1/2 x 23 3/4)	3 (24 x 23 1/2)	6 (23 x 23 1/2)	9 (23 x 23 1/2 (L/R), 25 1/4 x 23 1/2 (M))
Net Weight (lbs.)	170	246	357	493
Gross Weight (lbs.)	194	270	401	559

Design and specifications subject to change without notice. Most updated spec sheets are available at www.turboairinc.com.

Actual shipping weight may differ due to extra packing materials for product protection.

* Depth does not include 2-1/4" for rear condensate enclosure. † Height does not include 4-3/4" for caster height.

■ **WARRANTY: 5 Year Parts and Labor Warranty, 7 Year Compressor Warranty**

HALF SOLID DOOR REFRIGERATORS **NATURAL Refrigerant**

Self-Cleaning Condenser Equipped Units

Self-Cleaning Condenser
Maintenance-free
during warranty period



M3R47-4-N

M3R24-2-N

■ **Self-Cleaning Condenser (Patented)**

The accumulation of dust in the condenser can cause the failure or breakdown of refrigerators. Refrigerators run normally until they reach a certain level of accumulation. At some point, when they are over the limit, their performance drops quickly resulting in damage to, or disposal of the stored products inside. The Self-Cleaning Condenser device keeps the condenser clean and prevents system failure by automatically brushing daily.

■ **Digital temperature control & monitor system**

- Keeps food products safe by maintaining constant temperatures
- Alarms that sound when doors are not sealed shut; protect against food spoilage that originates from cold air leaks
- Early warning alarm program detects issues before malfunction occurs
- Digital display allows for easy monitoring
- Programs interpret the condition of refrigeration systems by self-diagnosis
- Rapid cool-down function (Turbo Cooling)
- Automatic evaporator fan motor delays

■ **Hydrocarbon refrigerants (R-290)**

With innovative and eco-friendly technology, Turbo Air brings you hydrocarbon refrigerators designed to meet DOE's Energy Conservation Standards in 2017 and to use EPA's SNAP Program approved HC refrigerants. Hydrocarbon refrigerants do not deplete the ozone layer and have very low contribution to global warming (ODP-0, GWP-3).

■ **Hot gas condensate system**

Through Turbo Air's creative innovation, the condensate system surfaces have been specially treated to resist corrosion. This not only increases efficiency without the risk of refrigerant leakage from corrosion, but also thoroughly prevents the overflow of condensate water.

■ **Stainless steel exterior**

The Turbo Air M3 refrigerator model boasts a stainless steel exterior (galvanized steel top, bottom and back) and AL interior with stainless steel floor. It guarantees the utmost in cleanliness and long product life. Sharp corners and edges have been rounded to reduce the risk of injury. The M3 adds a touch of style to the most refined setting.

■ **LED interior lighting**

■ **Adjustable, heavy duty, PE (polyethylene) coated wire shelves**

■ **High-density polyurethane insulation**

The entire cabinet structure and solid doors are foamed-in-place using high density, CFC free polyurethane insulation.

■ **Left hinged (M3R24-2-N-L), all left hinged (M3R47-4-N-AL), all right hinged (M3R47-4-N-AR) models available**

Door pressure release device (Patented)

Pressure relief doors are designed to eliminate vacuum pressure and allow easy door opening.

■ **Refrigerator holds 33°F ~ 38°F for the best in food preservation**

■ **Top mount compressor**

■ **Standard features**

- Anti-corrosion coated evaporator
- Self-contained system
- 4" dia. swivel casters with locks on the front set
- Door locks
- Solid and sturdy grille design

■ **Optional features**

- Legs available for all models
- Half pan racks available

M3R MODELS SPECIFICATIONS

ELECTRICAL DATA	M3R24-2-N	M3R47-4-N	M3R72-6-N
Voltage	115/60/1	115/60/1	115/60/1
Plug Type	Ⓜ NEMA 5-15P	Ⓜ NEMA 5-15P	Ⓜ NEMA 5-15P
Full Load Amp.	2.5	2.8	5.6
Compressor HP	1/4+	1/3	3/8
Cord Length (ft.)	9	9	9
Refrigerant	R-290	R-290	R-290
DIMENSIONAL DATA			
Net Capacity (cu. ft.)	21.5	42.1	65.6
Ext. Dimension (L x D* x H†) (in.)	28 ³ / ₄ x 33 ⁷ / ₈ x 78	51 ³ / ₄ x 33 ⁷ / ₈ x 78	77 ³ / ₄ x 33 ⁷ / ₈ x 78
# of Doors	2	4	6
# of Racks Accepted	1	2	3
# of Shelves (Size (L x D) (in.))	3 (24 x 23 ¹ / ₂)	6 (23 x 23 ¹ / ₂)	9 (23 x 23 ¹ / ₂ (L/R), 25 ¹ / ₄ x 23 ¹ / ₂ (M))
Net Weight (lbs.)	246	357	493
Gross Weight (lbs.)	270	401	559

Design and specifications subject to change without notice. Most updated spec sheets are available at www.turboairinc.com.

Actual shipping weight may differ due to extra packing materials for product protection.

* Depth does not include 2-3/8" for rear condensate enclosure. † Height does not include 4-7/8" for caster height.

■ **WARRANTY: 5 Year Parts and Labor Warranty, 7 Year Compressor Warranty**

GLASS DOOR REFRIGERATORS NATURAL Refrigerant

Self-Cleaning Condenser Equipped Units

Self-Cleaning Condenser (Patented)

The accumulation of dust in the condenser can cause the failure or breakdown of refrigerators. Refrigerators run normally until they reach a certain level of accumulation. At some point, when they are over the limit, their performance drops quickly resulting in damage to, or disposal of the stored products inside. The Self-Cleaning Condenser device keeps the condenser clean and prevents system failure by automatically brushing daily.

Digital temperature control & monitor system

- Keeps food products safe by maintaining constant temperatures
- Alarms that sound when doors are not sealed shut; protects against food spoilage that originates from cold air leaks
- Early warning alarm program detects issues before malfunction occurs
- Digital display allows for easy monitoring
- Programs interpret the condition of refrigeration systems by self-diagnosis
- Rapid cool-down function (Turbo Cooling)
- Automatic evaporator fan motor delays

Hydrocarbon refrigerants (R-290)

With innovative and eco-friendly technology, Turbo Air brings you hydrocarbon refrigerators designed to meet DOE's Energy Conservation Standards in 2017 and to use EPA's SNAP Program approved HC refrigerants. Hydrocarbon refrigerants do not deplete the ozone layer and have very low contribution to global warming (ODP-0, GWP-3).

Hot gas condensate system

Through Turbo Air's creative innovation, the condensate system surfaces have been specially treated to resist corrosion. This not only increases efficiency without the risk of refrigerant leakage from corrosion, but also thoroughly prevents the overflow of condensate water.

Stainless steel cabinet construction

The Turbo Air M3 refrigerator model boasts a stainless steel exterior (galvanized steel top, bottom and back) and interior. It guarantees the utmost in cleanliness and long product life. Sharp corners and edges have been rounded to reduce the risk of injury. The M3 adds a touch of style to the most refined setting.

LED interior lighting

Adjustable, heavy duty, PE (polyethylene) coated wire shelves

Top mount compressor

Refrigerator holds 33°F ~ 38°F for the best in food preservation

Left hinged models available (M3R24-1-G-N-L & M3R24-1-G-N-TS-L)

Self-Cleaning Condenser
Maintenance-free
during warranty period



M3R47-2-G-N

M3R24-1-G-N

Door pressure release device (Patented)

Pressure relief doors are designed to eliminate vacuum pressure and allow easy door opening.

Standard features

- Anti-corrosion coated evaporator
- Self-contained system
- 4" dia. swivel casters with locks on the front set
- Door locks
- Solid and sturdy grille design
- High-density polyurethane insulation

Optional features

- Legs available for all models
- Full and half pan racks available

M3R-G MODELS SPECIFICATIONS

ELECTRICAL DATA	M3R24-1-G-N	M3R24-1-G-N-TS	M3R47-2-G-N
Voltage	115/60/1	115/60/1	115/60/1
Plug Type	Ⓜ NEMA 5-15P	Ⓜ NEMA 5-15P	Ⓜ NEMA 5-15P
Full Load Amp.	2.5	2.5	2.5
Compressor HP	1/4+	1/4+	1/3
Cord Length (ft.)	9	9	9
Refrigerant	R-290	R-290	R-290
DIMENSIONAL DATA			
Net Capacity (cu. ft.)	23.0	23.0	44.7
Ext. Dimension (L x D [†] x H [†]) (in.)	28 ³ / ₄ x 30 ³ / ₄ x 78	28 ³ / ₄ x 35 ¹ / ₈ x 82 ⁵ / ₈	51 ³ / ₄ x 30 ³ / ₄ x 78
# of Doors	1	1	2
# of Racks Accepted	1	-	2
# of Shelves (Size (L x D) (in.))	3 (24 x 23 ¹ / ₂)	3 (24 x 23 ¹ / ₂)	6 (23 x 23 ¹ / ₂)
Net Weight (lbs.)	259	259	379
Gross Weight (lbs.)	283	283	423

Design and specifications subject to change without notice. Most updated spec sheets are available at www.turboairinc.com.

Actual shipping weight may differ due to extra packing materials for product protection.

* Depth does not include 4-3/8" and 1-3/8"(TS) for door handles and rear condensate enclosure. † Height does not include 5" and 5-1/8"(TS) for caster height.

WARRANTY: 5 Year Parts and Labor Warranty, 7 Year Compressor Warranty

SOLID DOOR FREEZERS **NATURAL Refrigerant**

Self-Cleaning Condenser Equipped Units

■ **Self-Cleaning Condenser (Patented)**

The accumulation of dust in the condenser can cause the failure or breakdown of refrigerators. Refrigerators run normally until they reach a certain level of accumulation. At some point, when they are over the limit, their performance drops quickly resulting in damage to, or disposal of the stored products inside. The Self-Cleaning Condenser device keeps the condenser clean and prevents system failure by automatically brushing daily.

■ **Digital temperature control & monitor system**

- Keeps food products safe by maintaining constant temperatures
- Alarms that sound when doors are not sealed shut; protects against food spoilage that originates from cold air leaks
- Early warning alarm program detects issues before malfunction occurs
- Digital display allows for easy monitoring
- Programs interpret the condition of refrigeration systems by self-diagnosis
- Rapid cool-down function (Turbo Freeze)
- Smart defrost system will defrost as needed
- Automatic evaporator fan motor delays

■ **Hydrocarbon refrigerants (R-290)**

With innovative and eco-friendly technology, Turbo Air brings you hydrocarbon refrigerators designed to meet DOE's Energy Conservation Standards in 2017 and to use EPA's SNAP Program approved HC refrigerants. Hydrocarbon refrigerants do not deplete the ozone layer and have very low contribution to global warming (ODP-0, GWP-3).

■ **Stainless steel exterior**

The Turbo Air M3 freezer model boasts a stainless steel exterior (galvanized steel top, bottom and back) and AL interior with stainless steel floor. It guarantees the utmost in cleanliness and long product life. Sharp corners and edges have been rounded to reduce the risk of injury. The M3 adds a touch of style to the most refined setting.

■ **Field reversible door hinge (M3F19-1-N, M3F24-1-N), all left hinged (M3F47-2-N-AL, M3F72-3-N-AL), all right hinged (M3F47-2-N-AR, M3F72-3-N-AR) models available**

■ **LED interior lighting**

■ **Adjustable, heavy duty, PE (polyethylene) coated wire shelves**

■ **Top mount compressor**

■ **Freezer holds -10°F ~ 0°F for the best in frozen food preservation**



Self-Cleaning Condenser Maintenance-free during warranty period

M3F47-2-N

M3F24-1-N

Door pressure release device (Patented)

Pressure relief doors are designed to eliminate vacuum pressure and allow easy door opening.

■ **Standard features**

- Anti-corrosion coated evaporator
- Self-contained system
- 4" dia. swivel casters with locks on the front set
- Door locks
- Solid and sturdy grille design
- High-density polyurethane insulation

■ **Optional features**

- Legs available for all models
- Full and half pan racks available (except M3F19-1-N)

M3F MODELS SPECIFICATIONS

ELECTRICAL DATA	M3F19-1-N	M3F24-1-N	M3F47-2-N	M3F72-3-N
Voltage	115/60/1	115/60/1	115/60/1	115/60/1
Plug Type	Ⓜ NEMA 5-15P	Ⓜ NEMA 5-15P	Ⓜ NEMA 5-15P	Ⓜ NEMA 5-15P
Full Load Amp.	4.5	4.4	6.3	7.9
Compressor HP	1/2	1/3+	1/2	1
Cord Length (ft.)	9	9	9	9
Refrigerant	R-290	R-290	R-290	R-290
DIMENSIONAL DATA				
Net Capacity (cu. ft.)	18.7	21.6	42.3	65.8
Ext. Dimension (L x D x H†) (in.)	25 ¹ / ₄ x 31 ¹ / ₂ x 72 ¹ / ₈	28 ³ / ₄ x 30 ³ / ₄ x 77 ⁷ / ₈	51 ⁷ / ₈ x 30 ³ / ₄ x 77 ⁷ / ₈	77 ³ / ₄ x 30 ³ / ₄ x 77 ⁷ / ₈
# of Doors	1	1	2	3
# of Racks Accepted	-	1	2	3
# of Shelves (Size (L x D) (in.))	3 (20 ¹ / ₂ x 23 ³ / ₄)	3 (24 x 23 ¹ / ₂)	6 (23 x 23 ¹ / ₂)	9 (23 x 23 ¹ / ₂ (L/R), 25 ¹ / ₄ x 23 ¹ / ₂ (M))
Net Weight (lbs.)	170	256	391	527
Gross Weight (lbs.)	194	280	435	571

Design and specifications subject to change without notice. Most updated spec sheets are available at www.turboairinc.com.

Actual shipping weight may differ due to extra packing materials for product protection.

* Depth does not include 2-1/4" for rear condensate enclosure. † Height does not include 4-3/4" for caster height.

■ **WARRANTY: 5 Year Parts and Labor Warranty, 7 Year Compressor Warranty**

HALF SOLID DOOR FREEZERS **NATURAL Refrigerant**

Self-Cleaning Condenser Equipped Units

■ **Self-Cleaning Condenser (Patented)**

The accumulation of dust in the condenser can cause the failure or breakdown of refrigerators. Refrigerators run normally until they reach a certain level of accumulation. At some point, when they are over the limit, their performance drops quickly resulting in damage to, or disposal of the stored products inside. The Self-Cleaning Condenser device keeps the condenser clean and prevents system failure by automatically brushing daily.

■ **Digital temperature control & monitor system**

- Keeps food products safe by maintaining constant temperatures
- Alarms that sound when doors are not sealed shut; protects against food spoilage that originates from cold air leaks
- Early warning alarm program detects issues before malfunction occurs
- Digital display allows for easy monitoring
- Programs interpret the condition of refrigeration systems by self-diagnosis
- Rapid cool-down function (Turbo Freeze)
- Smart defrost system will defrost as needed
- Automatic evaporator fan motor delays

■ **Hydrocarbon refrigerants (R-290)**

With innovative and eco-friendly technology, Turbo Air brings you hydrocarbon refrigerators designed to meet DOE's Energy Conservation Standards in 2017 and to use EPA's SNAP Program approved HC refrigerants. Hydrocarbon refrigerants do not deplete the ozone layer and have very low contribution to global warming (ODP-0, GWP-3).

■ **Stainless steel exterior**

The Turbo Air M3 freezer model boasts a stainless steel exterior (galvanized steel top, bottom and back) and AL interior with stainless steel floor. It guarantees the utmost in cleanliness and long product life. Sharp corners and edges have been rounded to reduce the risk of injury. The M3 adds a touch of style to the most refined setting.

■ **Adjustable, heavy duty, PE (polyethylene) coated wire shelves**

■ **High-density polyurethane insulation**

The entire cabinet structure and solid doors are foamed-in-place using high density, CFC free polyurethane insulation.

■ **Left hinged model available (M3F24-2-N-L)**

■ **LED interior lighting**

■ **Top mount compressor**

■ **Freezer holds -10°F ~ 0°F for the best in frozen food preservation**



Self-Cleaning Condenser Maintenance-free during warranty period

M3F72-6-N

M3F24-2-N

■ **Door pressure release device (Patented)**

Pressure relief doors are designed to eliminate vacuum pressure and allow easy door opening.

■ **Standard features**

- Anti-corrosion coated evaporator
- Self-contained system
- 4" dia. swivel casters with locks on the front set
- Door locks
- Solid and sturdy grille design

■ **Optional features**

- Legs available for all models
- Half pan racks available

M3F MODELS SPECIFICATIONS

ELECTRICAL DATA	M3F24-2-N	M3F47-4-N	M3F72-6-N
Voltage	115/60/1	115/60/1	115/60/1
Plug Type	Ⓜ NEMA 5-15P	Ⓜ NEMA 5-15P	Ⓜ NEMA 5-15P
Full Load Amp.	4.4	6.3	7.9
Compressor HP	3/8	2/3	3/4
Cord Length (ft.)	9	9	9
Refrigerant	R-290	R-290	R-290
DIMENSIONAL DATA			
Net Capacity (cu. ft.)	21.5	42.1	65.6
Ext. Dimension (L x D x H†) (in.)	28 ³ / ₄ x 30 ³ / ₄ x 78	51 ³ / ₄ x 30 ³ / ₄ x 78	77 ³ / ₄ x 30 ³ / ₄ x 78
# of Doors	2	4	6
# of Racks Accepted	1	2	3
# of Shelves (Size (L x D) (in.))	3 (24 x 23 ¹ / ₂)	6 (23 x 23 ¹ / ₂)	9 (23 x 23 ¹ / ₂ (L/R), 25 ¹ / ₄ x 23 ¹ / ₂ (M))
Net Weight (lbs.)	258	391	578
Gross Weight (lbs.)	282	435	644

Design and specifications subject to change without notice. Most updated spec sheets are available at www.turboairinc.com.

Actual shipping weight may differ due to extra packing materials for product protection.

* Depth does not include 2-3/8" for rear condensate enclosure. † Height does not include 4-7/8" for caster height.

■ **WARRANTY: 5 Year Parts and Labor Warranty, 7 Year Compressor Warranty**

SOLID DOOR DUAL TEMPERATURE NATURAL Refrigerant

Self-Cleaning Condenser Equipped Units

■ **Self-Cleaning Condenser (Patented)**

The accumulation of dust in the condenser can cause the failure or breakdown of refrigerators. Refrigerators run normally until they reach a certain level of accumulation. At some point, when they are over the limit, their performance drops quickly resulting in damage to, or disposal of the stored products inside. The Self-Cleaning Condenser device keeps the condenser clean and prevents system failure by automatically brushing daily.

■ **Digital temperature control & monitor system**

- Keeps food products safe by maintaining constant temperatures
- Alarms that sound when doors are not sealed shut; protects against food spoilage that originates from cold air leaks
- Early warning alarm program detects issues before malfunction occurs
- Digital display allows for easy monitoring
- Programs interpret the condition of refrigeration systems by self-diagnosis
- Rapid cool-down function (Turbo Freeze & Turbo Cooling)
- Smart defrost system will defrost as needed
- Automatic evaporator fan motor delays

■ **Hydrocarbon refrigerants (R-290)**

With innovative and eco-friendly technology, Turbo Air brings you hydrocarbon refrigerators designed to meet DOE's Energy Conservation Standards in 2017 and to use EPA's SNAP Program approved HC refrigerants. Hydrocarbon refrigerants do not deplete the ozone layer and have very low contribution to global warming (ODP-0, GWP-3).

■ **Two separate refrigeration systems (M3RF45-2-N)**

The M3 series dual temp. model is designed with two separate compressors for refrigerator & freezer. The single section model is built as a refrigerator on the top half and as a freezer on the bottom half. The two section model is built as a **freezer on the left 35% and as a refrigerator on the right 65%**.

■ **Stainless steel exterior**

Stainless steel exterior (galvanized steel top, bottom and back) and AL interior with stainless steel floor. It guarantees the utmost in cleanliness and long product life. Unlike other companies' products, sharp corners and edges have been rounded to reduce the risk of injury.

■ **Adjustable, heavy duty, PE (polyethylene) coated wire shelves**

■ **Left hinged model available (M3RF19-2-N-L)**

■ **LED interior lighting**

■ **Refrigerator holds 33°F ~ 38°F, and freezer holds -10°F ~ 0°F for the best in food preservation**

Self-Cleaning Condenser
Maintenance-free
during warranty period



Door pressure release device (Patented, M3RF45-2-N only)
Pressure relief doors are designed to eliminate vacuum pressure and allow easy door opening.

■ **Standard features**

- Anti-corrosion coated evaporator
- Self-contained system
- 4" dia. swivel casters with locks on the front set
- Door locks
- Solid and sturdy grille design
- High-density polyurethane insulation

■ **Optional features**

- Legs available for all models

M3RF MODELS SPECIFICATIONS

ELECTRICAL DATA	M3RF19-2-N	M3RF45-2-N
Voltage	115/60/1	115/60/1
Plug Type	Ⓢ NEMA 5-15P	Ⓢ NEMA 5-15P
Full Load Amp.	4.8	6
Compressor HP	3/8+	1/3 (F) / 1/4 (R)
Cord Length (ft.)	9	9
Refrigerant	R-290	R-290
DIMENSIONAL DATA		
Net Capacity (cu. ft.)	8.39 (F) / 8.87 (R)	15 (F) / 20.93 (R)
Ext. Dimension (L x D x H†) (in.)	25 1/4 x 31 1/2 x 72 1/8	49 5/8 x 31 1/2 x 72 1/8
# of Doors	2	2
# of Shelves (Size (L x D) (in.))	2 (20 1/2 x 23 3/4)	6 (17 x 24 1/2 (F) / 24 x 24 1/2 (R))
Net Weight (lbs.)	187	335
Gross Weight (lbs.)	220	415

Design and specifications subject to change without notice. Most updated spec sheets are available at www.turboairinc.com.

Actual shipping weight may differ due to extra packing materials for product protection.

* Depth does not include 2-3/8" for rear condensate enclosure. † Height does not include 4-7/8" for caster height.

■ **WARRANTY: 5 Year Parts and Labor Warranty, 7 Year Compressor Warranty**

SOLID DOOR HEATED CABINETS

■ **Digital temperature control & monitor system**

- Keeps food products safe by maintaining constant temperatures
- Alarm beeps when doors are not sealed
- Digital display allows for easy monitoring

■ **Ducted fan air distribution system**

Maintains temperature within the food zone.

■ **On/Off switch**

ON/OFF switch is located on control panel

■ **Stainless steel cabinet construction**

The Turbo Air M3 heated cabinet model boasts a stainless steel exterior (galvanized steel top, bottom and back) and interior. It guarantees the utmost in cleanliness and long product life. Sharp corners and edges have been rounded to reduce the risk of injury. The M3 adds a touch of style to the most refined setting.

■ **LED interior lighting**

■ **High-density polyurethane insulation**

Structure and solid doors are foamed-in-place using high density, CFC free polyurethane insulation.

■ **Self-closing doors with stay open feature at 120 degrees**

■ **Heated cabinet holds 140°F ~ 180°F for the best in food preservation**

■ **Field reversible door hinge (M3H24-1, M3H24-1-TS)**

■ **Stainless steel universal tray slides (M3H24-1-TS, M3H47-2-TS)**

Each tray slide accommodates up to one (1) 6" deep full size pan or one (1) 18" x 26" size pan or two (2) 14" x 18" size pans or three (3) 12" x 20" size pans.

■ **Standard features**

- Door locks
- 4" dia. swivel casters with locks on the front set
- Easy replaceable one piece magnetic door gaskets
- Lead time applies

■ **Optional features**

- Legs available for all models
- Full and half pan racks available (only M3H24-1, M3H47-2)



M3H MODELS SPECIFICATIONS

ELECTRICAL DATA	M3H24-1	M3H47-2	M3H24-1-TS	M3H47-2-TS
Voltage	115/60/1	115/60/1	115/60/1	115/60/1
Plug Type	Ⓜ NEMA 5-15P	Ⓜ NEMA 5-15P	Ⓜ NEMA 5-15P	Ⓜ NEMA 5-15P
Full Load Amp.	8.5	13.5	8.5	13.5
Wattage (W)	950	1550	950	1550
Cord Length (ft.)	8	8	8	8
DIMENSIONAL DATA				
Net Capacity (cu. ft.)	22.7	42.9	22.7	42.9
Ext. Dimension (L x D x H†) (in.)	28 ³ / ₄ x 30 ³ / ₄ x 78	51 ³ / ₄ x 30 ³ / ₄ x 78	28 ³ / ₄ x 30 ³ / ₄ x 78	51 ³ / ₄ x 30 ³ / ₄ x 78
# of Doors	1	2	1	2
# of Racks Accepted	1	2	-	-
# of Shelves (Size (L x D) (in.))	3 (23 ¹ / ₂ x 21 ⁵ / ₈)	6 (23 ¹ / ₂ x 21 ⁵ / ₈)	-	-
# of Tray slides (pairs)	-	-	5	10
Net Weight (lbs.)	188	282	188	282
Gross Weight (lbs.)	231	345	231	345

Design and specifications subject to change without notice. Most updated spec sheets are available at www.turboairinc.com.

Actual shipping weight may differ due to extra packing materials for product protection.

† Height does not include 5" for caster height.

■ **WARRANTY: 3 Year Parts and Labor Warranty**

GLASS DOOR HEATED CABINETS

■ **Digital temperature control & monitor system**

- Keeps food products safe by maintaining constant temperatures
- Alarm beeps when doors are not sealed
- Digital display allows for easy monitoring

■ **Ducted fan air distribution system**

Maintains temperature within the food zone.

■ **On/Off switch**

ON/OFF switch is located on control panel

■ **Stainless steel cabinet construction**

The Turbo Air M3 heated cabinet boasts a stainless steel exterior (galvanized steel top, bottom and back) and interior. It guarantees the utmost in cleanliness and long product life. Sharp corners and edges have been rounded to reduce the risk of injury. The M3 adds a touch of style to the most refined setting.

■ **LED interior lighting**

■ **High-density polyurethane insulation**

Structure and solid doors are foamed-in-place using high density, CFC free polyurethane insulation.

■ **Stainless steel doors with glass window**

■ **Self-closing doors with stay open feature at 120 degrees (except PT model)**

■ **Heated cabinet holds 140°F ~ 180°F for the best in food preservation**

■ **Stainless steel universal tray slides standard (M3H24-1-G-TS, M3H47-2-G-TS)**

Each tray slide accommodates up to one (1) 6" deep full size pan or one (1) 18" x 26" size pan or two (2) 14" x 18" size pans or three (3) 12" x 20" size pans.

■ **Left hinged models available (M3H24-1-G-L, M3H24-1-G-TS-L)**

■ **Standard features**

- Door locks
- 4" dia. swivel casters with locks on the front set
- Easy replaceable one piece magnetic door gaskets
- Lead time applies



■ **Optional features**

- Legs available for all models
- Full and half pan racks available (only M3H24-1-G, M3H47-2-G)

M3H-G MODELS SPECIFICATIONS

ELECTRICAL DATA	M3H24-1-G	M3H24-1-G-PT	M3H47-2-G	M3H24-1-G-TS	M3H47-2-G-TS
Voltage	115/60/1	115/60/1	115/60/1	115/60/1	115/60/1
Plug Type	Ⓜ NEMA 5-15P	Ⓜ NEMA 5-15P	Ⓜ NEMA 5-15P	Ⓜ NEMA 5-15P	Ⓜ NEMA 5-15P
Full Load Amp.	8.5	8.5	13.5	8.5	13.5
Wattage (W)	950	950	1550	950	1550
Cord Length (ft.)	8	8	8	8	8
DIMENSIONAL DATA					
Net Capacity (cu. ft.)	22.7	22.7	42.9	22.7	42.9
Ext. Dimension (L x D x H†) (in.)	28 ³ / ₄ x 30 ³ / ₄ x 78	28 ³ / ₄ x 33 ¹ / ₄ x 78	51 ³ / ₄ x 30 ³ / ₄ x 78	28 ³ / ₄ x 30 ³ / ₄ x 78	51 ³ / ₄ x 30 ³ / ₄ x 78
# of Doors	1	1	2	1	2
# of Racks Accepted	1	1	2	-	-
# of Shelves (Size (L x D) (in.))	3 (23 ¹ / ₂ x 21 ⁵ / ₈)	3 (23 ¹ / ₂ x 21 ⁵ / ₈)	6 (23 ¹ / ₂ x 21 ⁵ / ₈)	-	-
# of Tray slides (pairs)	-	-	-	5	10
Net Weight (lbs.)	201	201	304	201	304
Gross Weight (lbs.)	244	244	367	244	367

Design and specifications subject to change without notice. Most updated spec sheets are available at www.turboairinc.com.

Actual shipping weight may differ due to extra packing materials for product protection.

* Depth does not include 1-3/8" and 2-7/8"(PT) for door handles. † Height does not include 5" for caster height.

■ **WARRANTY: 3 Year Parts and Labor Warranty**

PASS-THRU SOLID & GLASS DOOR HEATED CABINETS

■ **Digital temperature control & monitor system**

- Keeps food products safe by maintaining constant temperatures
- Alarm beeps when doors are not sealed
- Digital display allows for easy monitoring

■ **Ducted fan air distribution system**

Maintains temperature within the food zone.

■ **On/Off switch**

ON/OFF switch is located on control panel

■ **Stainless steel cabinet construction**

The Turbo Air M3 heated cabinet model boasts a stainless steel exterior (galvanized steel top, bottom and back) and interior. It guarantees the utmost in cleanliness and long product life. Sharp corners and edges have been rounded to reduce the risk of injury. The M3 adds a touch of style to the most refined setting.

■ **LED interior lighting**

■ **High-density polyurethane insulation**

The entire cabinet structure and solid doors are foamed-in-place using high density, CFC free polyurethane insulation.

■ **Field reversible door hinge**

■ **Adjustable, stainless steel wire shelves**

■ **Heated cabinet holds 140°F ~ 180°F for the best in food preservation**

■ **Standard features**

- Door locks
- 4" dia. swivel casters with locks on the front set
- Easy replaceable one piece magnetic door gaskets
- Solid and sturdy grille design

■ **Optional features**

- Legs available for all models
- Full and half pan racks available



M3H24-1-G-PT



M3H47-2-PT

M3H-PT MODELS SPECIFICATIONS

ELECTRICAL DATA	M3H24-1-PT	M3H24-1-G-PT	M3H47-2-PT
Voltage	115/60/1	115/60/1	115/60/1
Plug Type	Ⓜ NEMA 5-15P	Ⓜ NEMA 5-15P	Ⓜ NEMA 5-15P
Full Load Amp.	8.5	8.5	13.5
Wattage (W)	950	950	1550
Cord Length (ft.)	8	8	8
DIMENSIONAL DATA			
Net Capacity (cu. ft.)	22.7	22.7	42.9
Ext. Dimension (L x D x H†) (in.)	28 ³ / ₄ x 33 ¹ / ₈ x 78	28 ³ / ₄ x 33 ¹ / ₄ x 78	51 ³ / ₄ x 33 ¹ / ₈ x 78
# of Doors	2	2	4
# of Racks Accepted	1	1	2
# of Shelves (Size (L x D) (in.))	3 (23 ¹ / ₂ x 21 ⁵ / ₈)	3 (23 ¹ / ₂ x 21 ⁵ / ₈)	6 (23 ¹ / ₂ x 21 ⁵ / ₈)
# of Tray slides (pairs)	-	-	-
Net Weight (lbs.)	188	201	282
Gross Weight (lbs.)	231	244	345

Design and specifications subject to change without notice. Most updated spec sheets are available at www.turboairinc.com.

Actual shipping weight may differ due to extra packing materials for product protection.

† Height does not include 5" for caster height.

■ **WARRANTY: 3 Year Parts and Labor Warranty**

PASS THRU SOLID DOOR HEATED CABINETS - UNIVERSAL TRAY SLIDE

■ **Digital temperature control & monitor system**

- Keeps food products safe by maintaining constant temperatures
- Alarm beeps when doors are not sealed
- Digital display allows for easy monitoring

■ **Ducted fan air distribution system**

Maintains temperature within the food zone.

■ **On/Off switch**

ON/OFF switch is located on control panel

■ **Stainless steel cabinet construction**

The Turbo Air M3 heated cabinet model boasts a stainless steel exterior (galvanized steel top, bottom and back) and interior. It guarantees the utmost in cleanliness and long product life. Sharp corners and edges have been rounded to reduce the risk of injury. The M3 adds a touch of style to the most refined setting.

■ **LED interior lighting**

■ **High-density polyurethane insulation**

The entire cabinet structure and solid doors are foamed-in-place using high density, CFC free polyurethane insulation.

■ **Field reversible door hinge**

■ **Stainless steel universal tray slides standard**

Each tray slide accommodates up to 6" deep full size pan or 18" x 26" size pan or 14" x 18" size pans or 12" x 20" size pans.

■ **Heated cabinet holds 140°F ~ 180°F for the best in food preservation**

■ **Standard features**

- Door locks
- 4" dia. swivel casters with locks on the front set
- Easy replaceable one piece magnetic door gaskets
- Lead time applies

■ **Optional features**

- Legs available for all models
- Full and half pan racks available



M3H24-1-PT-TS

M3H47-2-PT-TS

M3H-PT-TS MODELS SPECIFICATIONS

ELECTRICAL DATA	M3H24-1-PT-TS	M3H47-2-PT-TS
Voltage	115/60/1	115/60/1
Plug Type	Ⓜ NEMA 5-15P	Ⓜ NEMA 5-15P
Full Load Amp.	8.5	13.5
Wattage (W)	950	1550
Cord Length (ft.)	8	8
DIMENSIONAL DATA		
Net Capacity (cu. ft.)	22.7	42.9
Ext. Dimension (L x D x H†) (in.)	28¾ x 33⅛ x 78	51¾ x 33⅛ x 78
# of Doors	2	4
# of Racks Accepted	-	2
# of Tray slides (pairs)	5	10
Net Weight (lbs.)	188	282
Gross Weight (lbs.)	231	345

Design and specifications subject to change without notice. Most updated spec sheets are available at www.turboairinc.com.

Actual shipping weight may differ due to extra packing materials for product protection.

† Height does not include 5" for caster height.

■ **WARRANTY: 3 Year Parts and Labor Warranty**



Hello **Brightness,** My New Friend

LED Interior Lighting & Food Safety Fan Control



Let's Watch Turbo Air's
Prep Tables & Undercounters
Video!



Prep Tables & Undercounters

- LED Interior lighting
- Energy saving fan control
- Digital temperature control & monitor system
- Maintenance free, Self-Cleaning Condenser
- Stainless steel cabinet construction

www.turboairinc.com

Refrigeration Reinvented **Turbo air** REFRIGERATOR MANUFACTURER



Food Prep Tables

PRO Series

Sandwich & Salad Units

- Solid / Glass Doors / Drawers / Glass Lid

Mega Top Units - Solid Doors / Drawers

Prep Table + Work Stations - Clear / Flat Lids

Mega Top Prep Table + Work Stations

- Clear / Flat Lids

Front Breathing Air Flow - Solid Doors / Drawers

Super Deluxe Series

Pizza Prep Tables - Solid Doors / Drawers

Sandwich & Salad Units

- Drawers / Solid / Specialty Lids

Prep Table + Work Stations - Drawers

Mega Top Units - Solid Doors / Drawers / Specialty Lids

Sandwich & Salad Units - Front Breathing Airflow

Mega Top Units - Front Breathing Airflow

M3 Series

Sandwich & Salad Units - Solid Doors

Mega Top Units - Solid Doors

Front Breathing Air Flow - Solid Doors / Drawers

J Series

Sandwich & Salad Units - Solid Doors

Buffet Display Tables - Solid Doors

E-line

Countertop Salad Tables

SANDWICH/SALAD UNITS NATURAL Refrigerant

Self-Cleaning Condenser Equipped Units

■ **Self-Cleaning Condenser (Patented)**

The accumulation of dust in the condenser can cause the failure or breakdown of refrigerators. Refrigerators run normally until they reach a certain level of accumulation. At some point, when they are over the limit, their performance drops quickly resulting in damage to, or disposal of the stored products inside. The Self-Cleaning Condenser device keeps the condenser clean and prevents system failure by automatically brushing daily.

■ **Digital temperature control & monitor system**

Keeps food products safe by maintaining constant temperatures. External digital display allows for easy monitoring.

■ **Hydrocarbon refrigerants (R-290)**

With innovative and eco-friendly technology, Turbo Air brings you hydrocarbon refrigerators designed to meet DOE's Energy Conservation Standards in 2017 and to use EPA's SNAP Program approved HC refrigerants. Hydrocarbon refrigerants do not deplete the ozone layer and have very low contribution to global warming (ODP-0, GWP-3).

■ **Cold Bunker system**

Our innovative forced air system allows cold air to flow all around the food pan area, covering not only underneath the pan, but also the front, top and the rear. This unique air flow creates a cold air-shield around the pan, which maintains the food temperature at under 41°F (NSF requirement) even when the lids are opened. In addition, the compartment isolates pans from the reach-in area to prevent food spillage.

■ **Stainless steel cabinet construction**

The PRO series model boasts a stainless steel interior and a 22 gauge stainless steel exterior (galvanized steel bottom). It guarantees the utmost in cleanliness and long product life. The PRO series adds a touch of style to the most refined setting.

■ **Sturdy, clean stainless steel shelving**

Shelves are the most important part of cleanliness as they come in direct contact with food. The PRO series uniquely provides stainless steel shelving.

■ **9-1/2" deep, 1/2" thick high-density Polyethylene cutting board included with convenient side rail**

■ **Left hinged (PST-28-N-L), all left hinged (PST-72-N-AL), all right hinged (PST-72-N-AR) models available**

■ **Spring assisted heavy duty gravity hinge**

■ **Easy removal hood & hood lid for cleaning**

■ **Insulated hood & hood lid**

■ **Refrigerator holds 33°F ~ 39°F for the best in food preservation**



LED interior lighting & fan control
Energy efficient LED lighting lights every corner, making items easy to find. Fan control function automatically shuts off the fan when the door is open, which prevents hot air from being drawn in, thus maintaining the cool inner temperature.

■ **Standard features**

- Anti-corrosion coated evaporator
- Self-contained system
- 4" dia. swivel casters with locks on the front set
- 1/6 size, 4" deep condiment pans included
- Door locks
- High-density polyurethane insulation
- Lead time applies

■ **Optional features**

- Stainless steel single/double overshef available (except PST-28-N)
- Removable food covers available
- Legs available for all models: 6"
- Casters available for all models: 1" (1.5" low profile caster kit for PST-28-N), 2.5" (except PST-28-N), 5"

PST MODELS SPECIFICATIONS

ELECTRICAL DATA	PST-28-N	PST-48-N	PST-60-N	PST-72-N
Voltage	115/60/1	115/60/1	115/60/1	115/60/1
Plug Type	Ⓜ NEMA 5-15P	Ⓜ NEMA 5-15P	Ⓜ NEMA 5-15P	Ⓜ NEMA 5-15P
Full Load Amp.	6.6	6.5	8.9	9.9
Compressor HP	1/6	1/5	1/5	3/8
Cord Length (ft.)	10	10	10	10
Refrigerant	R-290	R-290	R-290	R-290
DIMENSIONAL DATA				
Net Capacity (cu. ft.)	7	12	16	19
Ext. Dimension (L x D [†] x H [†]) (in.)	27 1/2 x 30 x 37 5/8	48 1/4 x 30 x 37 5/8	60 1/4 x 30 x 37 5/8	72 5/8 x 30 x 37 5/8
# of Doors	1	2	2	2
# of Shelves (Size (L x D) (in.))	1 (22 1/2 x 17)	2 (21 x 17)	2 (27 x 17)	2 (33 1/8 x 17)
# of Pans	8	12	16	18
Net Weight (lbs.)	179	255	298	361
Gross Weight (lbs.)	195	272	316	372

Design and specifications subject to change without notice. Most updated spec sheets are available at www.turboairinc.com.

Actual shipping weight may differ due to extra packing materials for product protection.

* Depth does not include 2" for door handles and rear spacers. † Height does not include 4-1/2" for caster height.

■ **WARRANTY: 5 Year Parts and Labor Warranty, 7 Year Compressor Warranty**

GLASS DOOR SANDWICH/SALAD UNITS NATURAL Refrigerant

Self-Cleaning Condenser Equipped Units

■ **Self-Cleaning Condenser (Patented)**

The accumulation of dust in the condenser can cause the failure or breakdown of refrigerators. Refrigerators run normally until they reach a certain level of accumulation. At some point, when they are over the limit, their performance drops quickly resulting in damage to, or disposal of the stored products inside. The Self-Cleaning Condenser device keeps the condenser clean and prevents system failure by automatically brushing daily.

■ **Digital temperature control & monitor system**

Keeps food products safe by maintaining constant temperatures. External digital display allows for easy monitoring.

■ **Hydrocarbon refrigerants (R-290)**

With innovative and eco-friendly technology, Turbo Air brings you hydrocarbon refrigerators designed to meet DOE's Energy Conservation Standards in 2017 and to use EPA's SNAP Program approved HC refrigerants. Hydrocarbon refrigerants do not deplete the ozone layer and have very low contribution to global warming (ODP-0, GWP-3).

■ **Cold Bunker system**

Our innovative forced air system allows cold air to flow all around the food pan area, covering not only underneath the pan, but also the front, top and the rear. This unique air flow creates a cold air-shield around the pan, which maintains the food temperature at under 41°F (NSF requirement) even when the lids are opened. In addition, the compartment isolates pans from the reach-in area to prevent food spillage.

■ **Stainless steel cabinet construction**

The PRO series model boasts a stainless steel interior and a **22 gauge** stainless steel exterior (galvanized steel bottom). It guarantees the utmost in cleanliness and long product life. The PRO series adds a touch of style to the most refined setting.

■ **Sturdy, clean stainless steel shelving**

Shelves are the most important part of cleanliness as they come in direct contact with food. The PRO series uniquely provides stainless steel shelving.

■ **9-1/2" deep, 1/2" thick high-density Polyethylene cutting board included with convenient side rail**

■ **Left hinged model available (PST-28-G-N-L)**

■ **Spring assisted heavy duty gravity hinge**

■ **Easy removal hood & hood lid for cleaning**

■ **Insulated hood & hood lid**

■ **Refrigerator holds 33°F ~ 39°F for the best in food preservation**



■ **LED interior lighting & fan control**

Energy efficient LED lighting lights every corner, making items easy to find. Fan control function automatically shuts off the fan when the door is open, which prevents hot air from being drawn in, thus maintaining the cool inner temperature.

■ **Standard features**

- Anti-corrosion coated evaporator
- Self-contained system
- 4" dia. swivel casters with locks on the front set
- 1/6 size, 4" deep condiment pans included
- Door locks
- High-density polyurethane insulation
- Lead time applies

■ **Optional features**

- Stainless steel single/double overshelf available (except PST-28-G-N)
- Removable food covers available
- Legs available for all models: 6"
- Casters available for all models: 1" (1.5" low profile caster kit for PST-28-G-N), 2.5" (except PST-28-G-N), 5"

PST-G MODELS SPECIFICATIONS

ELECTRICAL DATA	PST-28-G-N	PST-48-G-N	PST-60-G-N	PST-72-G-N
Voltage	115/60/1	115/60/1	115/60/1	115/60/1
Plug Type	Ⓢ NEMA 5-15P	Ⓢ NEMA 5-15P	Ⓢ NEMA 5-15P	Ⓢ NEMA 5-15P
Full Load Amp.	6.6	6.5	8.9	9.9
Compressor HP	1/6	1/5	1/5	3/8
Cord Length (ft.)	10	10	10	10
Refrigerant	R-290	R-290	R-290	R-290
DIMENSIONAL DATA				
Net Capacity (cu. ft.)	7	12	16	19
Ext. Dimension (L x D x H†) (in.)	27 1/2 x 30 x 37 5/8	48 1/4 x 30 x 37 5/8	60 1/4 x 30 x 37 5/8	72 5/8 x 30 x 37 5/8
# of Doors	1	2	2	2
# of Shelves (Size (L x D) (in.))	1 (22 1/2 x 17)	2 (21 x 17)	2 (27 x 17)	2 (33 1/8 x 17)
# of Pans	8	12	16	18
Net Weight (lbs.)	194	267	308	374
Gross Weight (lbs.)	211	287	334	389

Design and specifications subject to change without notice. Most updated spec sheets are available at www.turboairinc.com.

Actual shipping weight may differ due to extra packing materials for product protection.

* Depth does not include 2" for door handles and rear spacers. † Height does not include 4-1/2" for caster height.

■ **WARRANTY: 5 Year Parts and Labor Warranty, 7 Year Compressor Warranty**

SANDWICH/SALAD UNITS - DRAWERS NATURAL Refrigerant

Self-Cleaning Condenser Equipped Units

■ **Self-Cleaning Condenser (Patented)**

The accumulation of dust in the condenser can cause the failure or breakdown of refrigerators. Refrigerators run normally until they reach a certain level of accumulation. At some point, when they are over the limit, their performance drops quickly resulting in damage to, or disposal of the stored products inside. The Self-Cleaning Condenser device keeps the condenser clean and prevents system failure by automatically brushing daily.

■ **Digital temperature control & monitor system**

Keeps food products safe by maintaining constant temperatures. External digital display allows for easy monitoring.

■ **Hydrocarbon refrigerants (R-290)**

With innovative and eco-friendly technology, Turbo Air brings you hydrocarbon refrigerators designed to meet DOE's Energy Conservation Standards in 2017 and to use EPA's SNAP Program approved HC refrigerants. Hydrocarbon refrigerants do not deplete the ozone layer and have very low contribution to global warming (ODP-0, GWP-3).

■ **Cold Bunker system**

Our innovative forced air system allows cold air to flow all around the food pan area, covering not only underneath the pan, but also the front, top and the rear. This unique air flow creates a cold air-shield around the pan, which maintains the food temperature at under 41°F (NSF requirement) even when the lids are opened. In addition, the compartment isolates pans from the reach-in area to prevent food spillage.

■ **Stainless steel cabinet construction**

The PRO series model boasts a stainless steel interior and a **22 gauge** stainless steel exterior (galvanized steel bottom). It guarantees the utmost in cleanliness and long product life. The PRO series adds a touch of style to the most refined setting.

■ **Sturdy, clean stainless steel shelving**

Shelves are the most important part of cleanliness as they come in direct contact with food. The PRO series uniquely provides stainless steel shelving (only PST-48-D2R(L)-N).

■ **9-1/2" deep, 1/2" thick high-density Polyethylene cutting board included with convenient side rail**

■ **Spring assisted heavy duty gravity hinge**

■ **Easy removal hood & hood lid for cleaning**

■ **Insulated hood & hood lid**

■ **Refrigerator holds 33°F ~ 39°F for the best in food preservation**



LED interior lighting & fan control
Energy efficient LED lighting lights every corner, making items easy to find. Fan control function automatically shuts off the fan when the door is open, which prevents hot air from being drawn in, thus maintaining the cool inner temperature (only PST-48-D2R(L)-N).

■ **Standard features**

- Anti-corrosion coated evaporator
- Self-contained system
- 4" dia. swivel casters with locks on the front set
- 1/6 size, 4" deep condiment pans included (top of cabinet)
- Door locks
- High-density polyurethane insulation
- Lead time applies

■ **Optional features**

- Stainless steel single/double overshelf available (except PST-28-D2-N)
- Removable food covers available
- Legs available for all models: 6"
- Casters available for all models: 1" (1.5" low profile caster kit for PST-28-D2-N), 2.5" (except PST-28-D2-N), 5"

PST MODELS SPECIFICATIONS

ELECTRICAL DATA	PST-28-D2-N	PST-48-D2R(L)-N	PST-48-D4-N
Voltage	115/60/1	115/60/1	115/60/1
Plug Type	Ⓢ NEMA 5-15P	Ⓢ NEMA 5-15P	Ⓢ NEMA 5-15P
Full Load Amp.	6.6	6.5	6.5
Compressor HP	1/6	1/5	1/5
Cord Length (ft.)	10	10	10
Refrigerant	R-290	R-290	R-290
DIMENSIONAL DATA			
Net Capacity (cu. ft.)	7	12	12
Ext. Dimension (L x D* x H†) (in.)	27 1/2 x 30 x 37 5/8	48 1/4 x 30 x 37 5/8	48 1/4 x 30 x 37 5/8
# of Doors	-	1	-
# of Drawers	2	2	4
# of Shelves (Size (L x D) (in.))	-	1 (21 x 17)	-
# of Pans	8	12	12
Net Weight (lbs.)	210	260	276
Gross Weight (lbs.)	216	266	282

Design and specifications subject to change without notice. Most updated spec sheets are available at www.turboairinc.com.

Actual shipping weight may differ due to extra packing materials for product protection.

* Depth does not include 2" for door handles and rear spacers. † Height does not include 4-1/2" for caster height.

■ **WARRANTY: 5 Year Parts and Labor Warranty, 7 Year Compressor Warranty**

SANDWICH/SALAD UNITS - DRAWERS NATURAL Refrigerant

Self-Cleaning Condenser Equipped Units

■ **Self-Cleaning Condenser (Patented)**

The accumulation of dust in the condenser can cause the failure or breakdown of refrigerators. Refrigerators run normally until they reach a certain level of accumulation. At some point, when they are over the limit, their performance drops quickly resulting in damage to, or disposal of the stored products inside. The Self-Cleaning Condenser device keeps the condenser clean and prevents system failure by automatically brushing daily.

■ **Digital temperature control & monitor system**

Keeps food products safe by maintaining constant temperatures. External digital display allows for easy monitoring.

■ **Hydrocarbon refrigerants (R-290)**

With innovative and eco-friendly technology, Turbo Air brings you hydrocarbon refrigerators designed to meet DOE's Energy Conservation Standards in 2017 and to use EPA's SNAP Program approved HC refrigerants. Hydrocarbon refrigerants do not deplete the ozone layer and have very low contribution to global warming (ODP-0, GWP-3).

■ **Cold Bunker system**

Our innovative forced air system allows cold air to flow all around the food pan area, covering not only underneath the pan, but also the front, top and the rear. This unique air flow creates a cold air-shield around the pan, which maintains the food temperature at under 41°F (NSF requirement) even when the lids are opened. In addition, the compartment isolates pans from the reach-in area to prevent food spillage.

■ **Stainless steel cabinet construction**

The PRO series model boasts a stainless steel interior and a 22 gauge stainless steel exterior (galvanized steel bottom). It guarantees the utmost in cleanliness and long product life. The PRO series adds a touch of style to the most refined setting.

■ **Sturdy, clean stainless steel shelving**

Shelves are the most important part of cleanliness as they come in direct contact with food. The PRO series uniquely provides stainless steel shelving (only PST-60-D2R(L)-N, PST-72-D2R(L)-N).

■ **9-1/2" deep, 1/2" thick high-density Polyethylene cutting board included with convenient side rail**

■ **Spring assisted heavy duty gravity hinge**

■ **Easy removal hood & hood lid for cleaning**

■ **Insulated hood & hood lid**

■ **Refrigerator holds 33°F ~ 39°F for the best in food preservation**

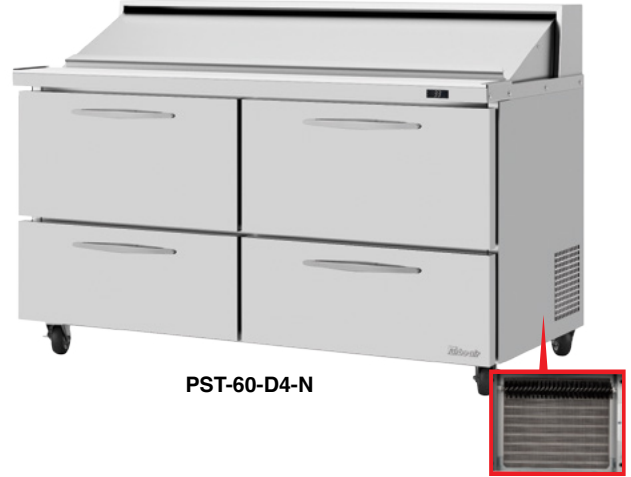

PST-60-D4-N

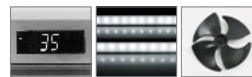

Self-Cleaning Condenser
Maintenance-free during warranty period

LED interior lighting & fan control

Energy efficient LED lighting lights every corner, making items easy to find. Fan control function automatically shuts off the fan when the door is open, which prevents hot air from being drawn in, thus maintaining the cool inner temperature (only PST-60-D2R(L)-N, PST-72-D2R(L)-N).

■ **Standard features**

- Anti-corrosion coated evaporator
- Self-contained system
- 4" dia. swivel casters with locks on the front set
- 1/6 size, 4" deep condiment pans included (top of cabinet)
- Door locks
- High-density polyurethane insulation
- Lead time applies

■ **Optional features**

- Stainless steel single/double overshef available
- Removable food covers available
- Legs available for all models: 6"
- Casters available for all models: 1", 2.5", 5"

PST MODELS SPECIFICATIONS

ELECTRICAL DATA	PST-60-D2R(L)-N	PST-60-D4-N	PST-72-D2R(L)-N	PST-72-D4-N	PST-72-D6-N
Voltage	115/60/1	115/60/1	115/60/1	115/60/1	115/60/1
Plug Type	Ⓜ NEMA 5-15P	Ⓜ NEMA 5-15P	Ⓜ NEMA 5-15P	Ⓜ NEMA 5-15P	Ⓜ NEMA 5-15P
Full Load Amp.	8.9	8.9	9.9	9.9	9.9
Compressor HP	1/5	1/5	3/8	3/8	3/8
Cord Length (ft.)	10	10	10	10	10
Refrigerant	R-290	R-290	R-290	R-290	R-290
DIMENSIONAL DATA					
Net Capacity (cu. ft.)	16	16	23	23	23
Ext. Dimension (L x D x H†) (in.)	60 ¹ / ₄ x 30 x 37 ⁵ / ₈	60 ¹ / ₄ x 30 x 37 ⁵ / ₈	72 ⁵ / ₈ x 30 x 37 ⁵ / ₈	72 ⁵ / ₈ x 30 x 37 ⁵ / ₈	72 ⁵ / ₈ x 30 x 37 ⁵ / ₈
# of Doors	1	-	1	-	-
# of Drawers	2	4	2	4	6
# of Shelves (Size (L x D) (in.))	1 (27 x 17)	-	1 (33 ¹ / ₈ x 17)	-	-
# of Pans	16	16	18	18	18
Net Weight (lbs.)	332	364	378	384	391
Gross Weight (lbs.)	338	371	382	395	402

Design and specifications subject to change without notice. Most updated spec sheets are available at www.turboairinc.com.

Actual shipping weight may differ due to extra packing materials for product protection.

* Depth does not include 2" for door handles and rear spacers. † Height does not include 4-1/2" for caster height.

■ **WARRANTY: 5 Year Parts and Labor Warranty, 7 Year Compressor Warranty**

SANDWICH/SALAD UNITS - GLASS LID NATURAL Refrigerant

Self-Cleaning Condenser Equipped Units

■ **Self-Cleaning Condenser (Patented)**

The accumulation of dust in the condenser can cause the failure or breakdown of refrigerators. Refrigerators run normally until they reach a certain level of accumulation. At some point, when they are over the limit, their performance drops quickly resulting in damage to, or disposal of the stored products inside. The Self-Cleaning Condenser device keeps the condenser clean and prevents system failure by automatically brushing daily.

■ **Digital temperature control & monitor system**

Keeps food products safe by maintaining constant temperatures. External digital display allows for easy monitoring.

■ **Hydrocarbon refrigerants (R-290)**

With innovative and eco-friendly technology, Turbo Air brings you hydrocarbon refrigerators designed to meet DOE's Energy Conservation Standards in 2017 and to use EPA's SNAP Program approved HC refrigerants. Hydrocarbon refrigerants do not deplete the ozone layer and have very low contribution to global warming (ODP-0, GWP-3).

■ **Cold Bunker system**

Our innovative forced air system allows cold air to flow all around the food pan area, covering not only underneath the pan, but also the front, top and the rear. This unique air flow creates a cold air-shield around the pan, which maintains the food temperature at under 41°F (NSF requirement) even when the lids are opened. In addition, the compartment isolates pans from the reach-in area to prevent food spillage.

■ **Stainless steel cabinet construction**

The PRO series model boasts a stainless steel interior and a **22 gauge** stainless steel exterior (galvanized steel bottom). It guarantees the utmost in cleanliness and long product life. The PRO series adds a touch of style to the most refined setting.

■ **Sturdy, clean stainless steel shelving**

Shelves are the most important part of cleanliness as they come in direct contact with food. The PRO series uniquely provides stainless steel shelving.

■ **High-density polyurethane insulation**

The entire cabinet structure and solid doors are foamed-in-place using high density, CFC free polyurethane insulation.

■ **6-1/4" deep, 1/2" thick high-density Polyethylene cutting board included with convenient side rail**

■ **Spring assisted heavy duty gravity hinge**

■ **Refrigerator holds 33°F ~ 39°F for the best in food preservation**

■ **Lifetime guaranteed heavy duty hinges and handles**

■ **Built to maintain NSF standard temperatures in 100°F ambient**



Self-Cleaning Condenser Maintenance-free during warranty period

PST-60-N-GL

PST-72-N-GL

LED interior lighting & fan control

Energy efficient LED lighting lights every corner, making items easy to find. Fan control function automatically shuts off the fan when the door is open, which prevents hot air from being drawn in, thus maintaining the cool inner temperature.

■ **Standard features**

- Anti-corrosion coated evaporator
- Self-contained system
- 4" dia. swivel casters with locks on the front set
- 1/6 size, 4" deep condiment pans included
 - * Accommodates 1/6 size, 6" deep condiment pans
- Door locks

■ **Optional features**

- Legs available for all models: 6"
- Casters available for all models: 1" (1" low profile caster kit for PST-28-N-GL), 2.5" (except PST-28-N-GL), 5"

PST MODELS SPECIFICATIONS

ELECTRICAL DATA	PST-28-N-GL	PST-48-N-GL	PST-60-N-GL	PST-72-N-GL
Voltage	115/60/1	115/60/1	115/60/1	115/60/1
Plug Type	Ⓜ NEMA 5-15P	Ⓜ NEMA 5-15P	Ⓜ NEMA 5-15P	Ⓜ NEMA 5-15P
Full Load Amp.	6.6	6.5	8.9	9.9
Compressor HP	1/6	1/5	1/5	3/8
Cord Length (ft.)	10	10	10	10
Refrigerant	R-290	R-290	R-290	R-290
DIMENSIONAL DATA				
Net Capacity (cu. ft.)	7	12	16	19
Ext. Dimension (L x D x H†) (in.)	28 x 32 7/8* x 31 3/4	48 1/4 x 32 7/8** x 31 3/4	60 1/4 x 32 7/8** x 31 3/4	72 5/8 x 32 7/8** x 31 3/4
# of Doors	1	2	2	2
# of Shelves (Size (L x D) (in.))	1 (22 1/2 x 17)	2 (21 x 17)	2 (27 x 17)	2 (33 1/8 x 17)
# of Pans	8	12	16	18
Net Weight (lbs.)	179	255	298	361
Gross Weight (lbs.)	195	272	316	372

Design and specifications subject to change without notice. Most updated spec sheets are available at www.turboairinc.com.

Actual shipping weight may differ due to extra packing materials for product protection.

* Depth does not include 3/4" for door handles. ** Depth does not include 2" for door handles and rear spacers. † Height does not include 4-1/2" for caster height.

■ **WARRANTY: 5 Year Parts and Labor Warranty, 7 Year Compressor Warranty**

MEGA TOP UNITS NATURAL Refrigerant

Self-Cleaning Condenser Equipped Units

■ **Self-Cleaning Condenser (Patented)**

The accumulation of dust in the condenser can cause the failure or breakdown of refrigerators. Refrigerators run normally until they reach a certain level of accumulation. At some point, when they are over the limit, their performance drops quickly resulting in damage to, or disposal of the stored products inside. The Self-Cleaning Condenser device keeps the condenser clean and prevents system failure by automatically brushing daily.

■ **Digital temperature control & monitor system**

Keeps food products safe by maintaining constant temperatures. External digital display allows for easy monitoring.

■ **Hydrocarbon refrigerants (R-290)**

With innovative and eco-friendly technology, Turbo Air brings you hydrocarbon refrigerators designed to meet DOE's Energy Conservation Standards in 2017 and to use EPA's SNAP Program approved HC refrigerants. Hydrocarbon refrigerants do not deplete the ozone layer and have very low contribution to global warming (ODP-0, GWP-3).

■ **Cold Bunker system**

Our innovative forced air system allows cold air to flow all around the food pan area, covering not only underneath the pan, but also the front, top and the rear. This unique air flow creates a cold air-shield around the pan, which maintains the food temperature at under 41°F (NSF requirement) even when the lids are opened. In addition, the compartment isolates pans from the reach-in area to prevent food spillage.

■ **Stainless steel cabinet construction**

The PRO series model boasts a stainless steel interior and a **22 gauge** stainless steel exterior (galvanized steel bottom). It guarantees the utmost in cleanliness and long product life. The PRO series adds a touch of style to the most refined setting.

■ **Sturdy, clean stainless steel shelving**

Shelves are the most important part of cleanliness as they come in direct contact with food. The PRO series uniquely provides stainless steel shelving.

■ **9-1/2" deep, 1/2" thick high-density Polyethylene cutting board included with convenient side rail**

■ **Left hinged (PST-28-12-N-L), all left hinged (PST-72-30-N-AL), all right hinged (PST-72-30-N-AR) models available**

■ **Spring assisted heavy duty gravity hinge**

■ **Easy removal hood & hood lid for cleaning**



LED interior lighting & fan control
Energy efficient LED lighting lights every corner, making items easy to find. Fan control function automatically shuts off the fan when the door is open, which prevents hot air from being drawn in, thus maintaining the cool inner temperature.

■ **Insulated hood & hood lid**

■ **Refrigerator holds 33°F ~ 39°F for the best in food preservation**

■ **Standard features**

- Anti-corrosion coated evaporator
- Self-contained system
- 4" dia. swivel casters with locks on the front set
- 1/6 size, 4" deep condiment pans included
- Door locks
- High-density polyurethane insulation
- Lead time applies

■ **Optional features**

- Stainless steel single/double overself available (except PST-28-12-N)
- Removable food covers available
- Legs available for all models: 6"
- Casters available for all models: 1" (1.5" low profile caster kit for PST-28-12-N), 2.5" (except PST-28-12-N), 5"

PST MODELS SPECIFICATIONS

ELECTRICAL DATA	PST-28-12-N	PST-48-18-N	PST-60-24-N	PST-72-30-N
Voltage	115/60/1	115/60/1	115/60/1	115/60/1
Plug Type	Ⓜ NEMA 5-15P	Ⓜ NEMA 5-15P	Ⓜ NEMA 5-15P	Ⓜ NEMA 5-15P
Full Load Amp.	6.6	6.5	8.9	9.9
Compressor HP	1/6	1/5	1/5	3/8
Cord Length (ft.)	10	10	10	10
Refrigerant	R-290	R-290	R-290	R-290
DIMENSIONAL DATA				
Net Capacity (cu. ft.)	8	15	19	23
Ext. Dimension (L x D [*] x H [†]) (in.)	27 1/2 x 34 x 39 5/8	48 1/4 x 34 x 39 1/8	60 1/4 x 34 x 39 5/8	72 5/8 x 34 x 39 5/8
# of Doors	1	2	2	2
# of Shelves (Size (L x D) (in.))	1 (22 1/2 x 17)	2 (21 x 17)	2 (27 x 17)	2 (33 1/8 x 17)
# of Pans	12	18	24	30
Net Weight (lbs.)	216	256	337	374
Gross Weight (lbs.)	220	264	352	396

Design and specifications subject to change without notice. Most updated spec sheets are available at www.turboairinc.com.

Actual shipping weight may differ due to extra packing materials for product protection.

* Depth does not include 3" for cutting boards and 1" for rear spacers. † Height does not include 4-1/2" for caster height.

■ **WARRANTY: 5 Year Parts and Labor Warranty, 7 Year Compressor Warranty**

MEGA TOP UNITS - DRAWERS NATURAL Refrigerant

Self-Cleaning Condenser Equipped Units

■ **Self-Cleaning Condenser (Patented)**

The accumulation of dust in the condenser can cause the failure or breakdown of refrigerators. Refrigerators run normally until they reach a certain level of accumulation. At some point, when they are over the limit, their performance drops quickly resulting in damage to, or disposal of the stored products inside. The Self-Cleaning Condenser device keeps the condenser clean and prevents system failure by automatically brushing daily.

■ **Digital temperature control & monitor system**

Keeps food products safe by maintaining constant temperatures. External digital display allows for easy monitoring.

■ **Hydrocarbon refrigerants (R-290)**

With innovative and eco-friendly technology, Turbo Air brings you hydrocarbon refrigerators designed to meet DOE's Energy Conservation Standards in 2017 and to use EPA's SNAP Program approved HC refrigerants. Hydrocarbon refrigerants do not deplete the ozone layer and have very low contribution to global warming (ODP-0, GWP-3).

■ **Cold Bunker system**

Our innovative forced air system allows cold air to flow all around the food pan area, covering not only underneath the pan, but also the front, top and the rear. This unique air flow creates a cold air-shield around the pan, which maintains the food temperature at under 41°F (NSF requirement) even when the lids are opened. In addition, the compartment isolates pans from the reach-in area to prevent food spillage.

■ **Stainless steel cabinet construction**

The PRO series model boasts a stainless steel interior and a **22 gauge** stainless steel exterior (galvanized steel bottom). It guarantees the utmost in cleanliness and long product life. The PRO series adds a touch of style to the most refined setting.

■ **Sturdy, clean stainless steel shelving**

Shelves are the most important part of cleanliness as they come in direct contact with food. The PRO series uniquely provides stainless steel shelving (only PST-48-18-D2R(L)-N, PST-60-24-D2R(L)-N).

■ **9-1/2" deep, 1/2" thick high-density Polyethylene cutting board included with convenient side rail**

■ **Spring assisted heavy duty gravity hinge (only PST-48-18-D2R(L)-N, PST-60-24-D2R(L)-N)**

■ **Easy removal hood & hood lid for cleaning**

■ **Insulated hood & hood lid**

■ **Refrigerator holds 33°F ~ 39°F for the best in food preservation**



LED interior lighting & fan control
Energy efficient LED lighting lights every corner, making items easy to find. Fan control function automatically shuts off the fan when the door is open, which prevents hot air from being drawn in, thus maintaining the cool inner temperature (only PST-48-18-D2R(L)-N, PST-60-24-D2R(L)-N).

■ **Standard features**

- Anti-corrosion coated evaporator
- Self-contained system
- 4" dia. swivel casters with locks on the front set
- 1/6 size, 4" deep condiment pans included (top of cabinet)
- Door locks (only PST-48-18-D2R(L)-N, PST-60-24-D2R(L)-N)
- High-density polyurethane insulation
- Lead time applies

■ **Optional features**

- Stainless steel single/double overshelf available (except PST-28-12-D2-N)
- Removable food covers available
- Legs available for all models: 6"
- Casters available for all models: 1" (1.5" low profile caster kit for PST-28-12-D2-N), 2.5" (except PST-28-12-D2-N), 5"

PST MODELS SPECIFICATIONS

ELECTRICAL DATA	PST-28-12-D2-N	PST-48-18-D2R(L)-N	PST-48-18-D4-N	PST-60-24-D2R(L)-N
Voltage	115/60/1	115/60/1	115/60/1	115/60/1
Plug Type	Ⓜ NEMA 5-15P	Ⓜ NEMA 5-15P	Ⓜ NEMA 5-15P	Ⓜ NEMA 5-15P
Full Load Amp.	6.6	6.5	6.5	8.9
Compressor HP	1/6	1/5	1/5	1/5
Cord Length (ft.)	10	10	10	10
Refrigerant	R-290	R-290	R-290	R-290
DIMENSIONAL DATA				
Net Capacity (cu. ft.)	7	15	15	19
Ext. Dimension (L x D [†] x H [†]) (in.)	27 1/2 x 34 x 39 5/8	48 1/4 x 34 x 39 5/8	48 1/4 x 34 x 39 5/8	60 1/4 x 34 x 39 5/8
# of Doors	-	1	-	1
# of Drawers	2	2	4	2
# of Shelves (Size (L x D) (in.))	-	1 (21 x 17)	-	1 (27 x 17)
# of Pans	12	18	18	24
Net Weight (lbs.)	225	270	286	342
Gross Weight (lbs.)	231	282	298	357

Design and specifications subject to change without notice. Most updated spec sheets are available at www.turboairinc.com.

Actual shipping weight may differ due to extra packing materials for product protection.

* Depth does not include 3" for cutting boards and 1" for rear spacers. † Height does not include 4-1/2" for caster height.

■ **WARRANTY: 5 Year Parts and Labor Warranty, 7 Year Compressor Warranty**

MEGA TOP UNITS - DRAWERS NATURAL Refrigerant

Self-Cleaning Condenser Equipped Units

■ **Self-Cleaning Condenser (Patented)**

The accumulation of dust in the condenser can cause the failure or breakdown of refrigerators. Refrigerators run normally until they reach a certain level of accumulation. At some point, when they are over the limit, their performance drops quickly resulting in damage to, or disposal of the stored products inside. The Self-Cleaning Condenser device keeps the condenser clean and prevents system failure by automatically brushing daily.

■ **Digital temperature control & monitor system**

Keeps food products safe by maintaining constant temperatures. External digital display allows for easy monitoring.

■ **Hydrocarbon refrigerants (R-290)**

With innovative and eco-friendly technology, Turbo Air brings you hydrocarbon refrigerators designed to meet DOE's Energy Conservation Standards in 2017 and to use EPA's SNAP Program approved HC refrigerants. Hydrocarbon refrigerants do not deplete the ozone layer and have very low contribution to global warming (ODP-0, GWP-3).

■ **Cold Bunker system**

Our innovative forced air system allows cold air to flow all around the food pan area, covering not only underneath the pan, but also the front, top and the rear. This unique air flow creates a cold air-shield around the pan, which maintains the food temperature at under 41°F (NSF requirement) even when the lids are opened. In addition, the compartment isolates pans from the reach-in area to prevent food spillage.

■ **Stainless steel cabinet construction**

The PRO series model boasts a stainless steel interior and a **22 gauge** stainless steel exterior (galvanized steel bottom). It guarantees the utmost in cleanliness and long product life. The PRO series adds a touch of style to the most refined setting.

■ **Sturdy, clean stainless steel shelving**

Shelves are the most important part of cleanliness as they come in direct contact with food. The PRO series uniquely provides stainless steel shelving (only PST-72-30-D2R(L)-N, PST-72-30-D4R(L)-N).

■ **9-1/2" deep, 1/2" thick high-density Polyethylene cutting board included with convenient side rail**

■ **Spring assisted heavy duty gravity hinge (only PST-72-30-D2R(L)-N, PST-72-30-D4R(L)-N)**

■ **Easy removal hood & hood lid for cleaning**

■ **Insulated hood & hood lid**

■ **Refrigerator holds 33°F ~ 39°F for the best in food preservation**

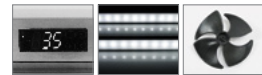

LED interior lighting & fan control
Energy efficient LED lighting lights every corner, making items easy to find. Fan control function automatically shuts off the fan when the door is open, which prevents hot air from being drawn in, thus maintaining the cool inner temperature (only PST-72-30-D2R(L)-N, PST-72-30-D4R(L)-N).

- **Standard features**
- Anti-corrosion coated evaporator
 - Self-contained system
 - 4" dia. swivel casters with locks on the front set
 - 1/6 size, 4" deep condiment pans included (top of cabinet)
 - Door locks (only PST-72-30-D2R(L)-N, PST-72-30-D4R(L)-N)
 - High-density polyurethane insulation
 - Lead time applies
- **Optional features**
- Stainless steel single/double overshelf available
 - Removable food covers available
 - Legs available for all models: 6"
 - Casters available for all models: 1", 2.5", 6"

PST MODELS SPECIFICATIONS

ELECTRICAL DATA	PST-60-24-D4-N	PST-72-30-D2R(L)-N	PST-72-30-D4-N	PST-72-30-D4R(L)-N	PST-72-30-D6-N
Voltage	115/60/1	115/60/1	115/60/1	115/60/1	115/60/1
Plug Type	Ⓜ NEMA 5-15P	Ⓜ NEMA 5-15P	Ⓜ NEMA 5-15P	Ⓜ NEMA 5-15P	Ⓜ NEMA 5-15P
Full Load Amp.	8.9	9.9	9.9	9.9	9.9
Compressor HP	1/5	3/8	3/8	3/8	3/8
Cord Length (ft.)	10	10	10	10	10
Refrigerant	R-290	R-290	R-290	R-290	R-290
DIMENSIONAL DATA					
Net Capacity (cu. ft.)	19	23	23	23	23
Ext. Dimension (L x D x H†) (in.)	60 1/4 x 34 x 39 5/8	72 5/8 x 34 x 39 5/8	72 5/8 x 34 x 39 5/8	72 5/8 x 34 x 39 5/8	72 5/8 x 34 x 39 5/8
# of Doors	-	1	-	1	-
# of Drawers	4	2	4	4	6
# of Shelves (Size (L x D) (in.))	-	1 (33 1/8 x 17)	-	1 (21 x 17)	-
# of Pans	24	30	30	30	30
Net Weight (lbs.)	374	384	395	405	416
Gross Weight (lbs.)	394	410	414	428	439

Design and specifications subject to change without notice. Most updated spec sheets are available at www.turboairinc.com. Actual shipping weight may differ due to extra packing materials for product protection. * Depth does not include 3" for cutting boards and 1-1/4" for rear spacers. † Height does not include 4-1/2" for caster height.

■ **WARRANTY: 5 Year Parts and Labor Warranty, 7 Year Compressor Warranty**

MEGA TOP UNITS - DRAWERS/FLAT LID NATURAL Refrigerant

Self-Cleaning Condenser Equipped Units

■ **Self-Cleaning Condenser (Patented)**

The accumulation of dust in the condenser can cause the failure or breakdown of refrigerators. Refrigerators run normally until they reach a certain level of accumulation. At some point, when they are over the limit, their performance drops quickly resulting in damage to, or disposal of the stored products inside. The Self-Cleaning Condenser device keeps the condenser clean and prevents system failure by automatically brushing daily.

■ **Digital temperature control & monitor system**

Keeps food products safe by maintaining constant temperatures. External digital display allows for easy monitoring.

■ **Hydrocarbon refrigerants (R-290)**

With innovative and eco-friendly technology, Turbo Air brings you hydrocarbon refrigerators designed to meet DOE's Energy Conservation Standards in 2017 and to use EPA's SNAP Program approved HC refrigerants. Hydrocarbon refrigerants do not deplete the ozone layer and have very low contribution to global warming (ODP-0, GWP-3).

■ **Cold Bunker system**

Our innovative forced air system allows cold air to flow all around the food pan area, covering not only underneath the pan, but also the front, top and the rear. This unique air flow creates a cold air-shield around the pan, which maintains the food temperature at under 41°F (NSF requirement) even when the lids are opened. In addition, the compartment isolates pans from the reach-in area to prevent food spillage.

■ **Stainless steel cabinet construction**

The PRO series model boasts a stainless steel interior and a 22 gauge stainless steel exterior (galvanized steel bottom). It guarantees the utmost in cleanliness and long product life. The PRO series adds a touch of style to the most refined setting.

■ **High-density polyurethane insulation**

The entire cabinet structure and solid doors are foamed-in place using high density, CFC free polyurethane insulation.

■ **9-1/2" deep, 1/2" thick high-density Polyethylene cutting board included with convenient side rail**

■ **Each top drawer accommodates up to 6" deep, one (1) full size pan or two (2) 1/3 size pans with two (2) 1/6 size pans or six (6) 1/6 size pans. And each bottom drawer accommodates up to 6" deep, two (2) 1/3 size pans or four (4) 1/6 size pans (drawer pans not included)**



PST-60-24-D4-N-FL

PST-48-18-D2R-N-FL

Self-Cleaning Condenser
Maintenance-free during warranty period

■ **Lifetime guaranteed heavy duty handles**

■ **Refrigerator holds 33°F ~ 39°F for the best in food preservation**

■ **Built to maintain NSF standard temperatures in 100°F ambient**

■ **Standard features**

- Anti-corrosion coated evaporator
- Self-contained system
- 4" dia. swivel casters with locks on the front set
- 1/6 size, 4" deep condiment pans included (top of cabinet)

■ **Optional features**

- Legs available for all models: 6"
- Casters available for all models: 1", 2.5", 6"

PST MODELS SPECIFICATIONS

ELECTRICAL DATA	PST-48-18-D2R(L)-N-FL	PST-48-18-D4-N-FL	PST-60-24-D4-N-FL
Voltage	115/60/1	115/60/1	115/60/1
Plug Type	Ⓢ NEMA 5-15P	Ⓢ NEMA 5-15P	Ⓢ NEMA 5-15P
Full Load Amp.	6.5	8.9	8.9
Compressor HP	1/5	1/5	1/5
Cord Length (ft.)	10	10	10
Refrigerant	R-290	R-290	R-290
DIMENSIONAL DATA			
Net Capacity (cu. ft.)	15	15	19
Ext. Dimension (L x D* x H†) (in.)	48 1/4 x 34 x 32 7/8	48 1/4 x 34 x 32 7/8	60 1/4 x 34 x 32 7/8
# of Doors	1	-	-
# of Drawers	2	4	4
# of Shelves (Size (L x D) (in.))	1	-	-
# of Pans	18	18	24
Net Weight (lbs.)	266	276	374
Gross Weight (lbs.)	278	288	394

Design and specifications subject to change without notice. Most updated spec sheets are available at www.turboairinc.com.

Actual shipping weight may differ due to extra packing materials for product protection.

* Depth does not include 3" for cutting boards and 1-1/4" for rear spacers. † Height does not include 5-1/8" for caster height.

■ **WARRANTY: 5 Year Parts and Labor Warranty, 7 Year Compressor Warranty**

MEGA TOP UNITS - SPECIALTY LIDS NATURAL Refrigerant

Self-Cleaning Condenser Equipped Units



PST Mega Top CL

Clear Lids

Model	Ext. dimension (L x D* x H†) (in.)	Net / Gross Weight (lbs.)
PST-28-12-N-CL	27 1/2 x 34 x 39 5/8	219 / 222
PST-48-18-N-CL	48 1/4 x 34 x 39 5/8	259 / 266
PST-60-24-N-CL	60 1/4 x 34 x 39 5/8	340 / 354
PST-72-30-N-CL	72 5/8 x 34 x 39 5/8	377 / 398

See page 87 for specification.



PST Mega Top GL

Glass Lids
6-1/4" deep cutting board

Model	Ext. dimension (L x D* x H†) (in.)	Net / Gross Weight (lbs.)
PST-48-18-N-GL	48 1/4 x 34 5/8 x 32 5/8	265 / 273
PST-60-24-N-GL	60 1/4 x 34 5/8 x 32 5/8	346 / 351
PST-72-30-N-GL	72 5/8 x 34 5/8 x 32 5/8	382 / 392

See page 87 for specification.



PST Mega Top FL

Flat Lids

Model	Ext. dimension (L x D* x H†) (in.)	Net / Gross Weight (lbs.)
PST-48-18-N-FL	48 1/4 x 34 x 33 1/2	253 / 261
PST-60-24-N-FL	60 1/4 x 34 x 33 1/2	333 / 349
PST-72-30-N-FL	72 5/8 x 34 x 33 1/2	371 / 393
PST-60-24-D4-N-FL	60 1/4 x 34 x 33 1/2	374 / 394

See pages 87 & 89 for specification.



PST Mega Top FCL

Flat Clear Lids

Model	Ext. dimension (L x D* x H†) (in.)	Net / Gross Weight (lbs.)
PST-48-18-N-FCL	48 1/4 x 34 x 32 1/8	246 / 254
PST-60-24-N-FCL	60 1/4 x 34 x 32 1/8	327 / 342
PST-72-30-N-FCL	72 5/8 x 34 x 32 1/8	364 / 386

See page 87 for specification.



PST Mega Top SL

Slide Back Lids

Model	Ext. dimension (L x D* x H†) (in.)	Net / Gross Weight (lbs.)
PST-28-12-N-SL	27 1/2 x 34 x 39 5/8	219 / 223
PST-36-15-N-SL	36 1/4 x 34 x 39 5/8	246 / 262
PST-48-18-N-SL	48 1/4 x 34 x 39 5/8	259 / 268
PST-60-24-N-SL	60 1/4 x 34 x 39 5/8	339 / 357
PST-72-30-N-SL	72 5/8 x 34 x 39 5/8	376 / 399

See page 87 for specification.

Design and specifications subject to change without notice. Most updated spec sheets are available at www.turboairinc.com.

Actual shipping weight may differ due to extra packing materials for product protection.

* Depth does not include 3" for cutting boards and 1" for rear spacers. ** Depth does not include 1" for cutting boards and 1" for rear spacers. † Height does not include 4-1/2" for caster height.

■ **WARRANTY: 5 Year Parts and Labor Warranty, 7 Year Compressor Warranty**

MEGA TOP UNITS - SPECIALITY LIDS NATURAL Refrigerant

Self-Cleaning Condenser Equipped Units



PST Mega Top DS

Dual Sided Lids

Model	Ext. dimension (L x D x H†) (in.)	Net / Gross Weight (lbs.)
PST-48-18-N-DS	48 1/4 x 46 1/2 x 40 5/8	273 / 282
PST-60-24-N-DS	60 1/4 x 46 1/2 x 40 5/8	354 / 370
PST-72-30-N-DS	72 5/8 x 46 1/2 x 40 5/8	391 / 414

See page 87 for specification.



PST Drawers SL

Slide Back Lids

Model	Ext. dimension (L x D* x H†) (in.)	Net / Gross Weight (lbs.)
PST-28-12-D2-N-SL	27 1/2 x 34 x 39 5/8	228 / 234
PST-48-18-D2R(L)-N-SL	48 1/4 x 34 x 39 5/8	273 / 286
PST-60-24-D2R(L)-N-SL	60 1/4 x 34 x 39 5/8	346 / 361
PST-72-30-D2R(L)-N-SL	72 5/8 x 34 x 39 5/8	387 / 413
PST-72-30-D4-N-SL	72 5/8 x 34 x 39 5/8	398 / 417
PST-72-30-D6-N-SL	72 5/8 x 34 x 39 5/8	419 / 442

See page 88 for specification.



PST Drawers RC

Removable cover

Model	Ext. dimension (L x D* x H†) (in.)	Net / Gross Weight (lbs.)
PST-72-30-D2R-N-RC	72 5/8 x 34 x 33 3/8	363 / 382

See page 89 for specification.



PST Drawers GL

Glass Lids
6-1/4" deep cutting board

Model	Ext. dimension (L x D** x H†) (in.)	Net / Gross Weight (lbs.)
PST-48-18-D2R(L)-N-GL	48 1/4 x 34 5/8 x 32 5/8	290 / 302
PST-60-24-D4-N-GL	60 1/4 x 34 5/8 x 32 5/8	362 / 377
PST-72-30-D4-N-GL	72 5/8 x 34 5/8 x 32 5/8	415 / 434
PST-72-30-D6-N-GL	72 5/8 x 34 5/8 x 32 5/8	424 / 439

See page 88 for specification.



PST Mega Top GL

Glass Lids
Prep Tables + Work Stations
6-1/4" deep cutting board

Model	Ext. dimension (L x D** x H†) (in.)	Net / Gross Weight (lbs.)
PST-60-18M-N-GL(-LW)	60 1/4 x 34 5/8 x 32 5/8	330 / 345
PST-72-18M-N-GL(-LW)	72 5/8 x 34 5/8 x 32 5/8	352 / 373

See page 87 for specification.

Design and specifications subject to change without notice. Most updated spec sheets are available at www.turboairinc.com.

Actual shipping weight may differ due to extra packing materials for product protection.

* Depth does not include 3" for cutting boards and 1" for rear spacers. ** Depth does not include 1" for cutting boards and 1" for rear spacers. † Height does not include 4-1/2" for caster height.

WARRANTY: 5 Year Parts and Labor Warranty, 7 Year Compressor Warranty

PREP TABLE + WORK STATIONS NATURAL Refrigerant

Self-Cleaning Condenser Equipped Units

■ **Self-Cleaning Condenser (Patented)**

The accumulation of dust in the condenser can cause the failure or breakdown of refrigerators. Refrigerators run normally until they reach a certain level of accumulation. At some point, when they are over the limit, their performance drops quickly resulting in damage to, or disposal of the stored products inside. The Self-Cleaning Condenser device keeps the condenser clean and prevents system failure by automatically brushing daily.

■ **Digital temperature control & monitor system**

Keeps food products safe by maintaining constant temperatures. External digital display allows for easy monitoring.

■ **Hydrocarbon refrigerants (R-290)**

With innovative and eco-friendly technology, Turbo Air brings you hydrocarbon refrigerators designed to meet DOE's Energy Conservation Standards in 2017 and to use EPA's SNAP Program approved HC refrigerants. Hydrocarbon refrigerants do not deplete the ozone layer and have very low contribution to global warming (ODP-0, GWP-3).

■ **Cold Bunker system**

Our innovative forced air system allows cold air to flow all around the food pan area, covering not only underneath the pan, but also the front, top and the rear. This unique air flow creates a cold air-shield around the pan, which maintains the food temperature at under 41°F (NSF requirement) even when the lids are opened. In addition, the compartment isolates pans from the reach-in area to prevent food spillage.

■ **Stainless steel cabinet construction**

The PRO series model boasts a stainless steel interior and a **22 gauge** stainless steel exterior (galvanized steel bottom). It guarantees the utmost in cleanliness and long product life. The PRO series adds a touch of style to the most refined setting.

■ **Sturdy, clean stainless steel shelving**

Shelves are the most important part of cleanliness as they come in direct contact with food. The PRO series uniquely provides stainless steel shelving.

■ **9-1/2" deep, 1/2" thick high-density Polyethylene cutting board included with convenient side rail**

■ **High-density polyurethane insulation**

The entire cabinet structure and solid doors are foamed-in-place using high density, CFC free polyurethane insulation.

■ **Spring assisted heavy duty gravity hinge**

■ **Easy removable hood & hood lid for cleaning**

■ **Insulated hood & hood lid**



PST-48-08S-N-LW

PST-60-08S-N



LED interior lighting & fan control

Energy efficient LED lighting lights every corner, making items easy to find. Fan control function automatically shuts off the fan when the door is open, which prevents hot air from being drawn in, thus maintaining the cool inner temperature.

■ **Refrigerator holds 33°F ~ 39°F for the best in food preservation**

■ **Lifetime guaranteed heavy duty hinges and handles**

■ **Built to maintain NSF standard temperatures in 100°F ambient**

■ **Standard features**

- Anti-corrosion coated evaporator
- Self-contained system
- 4" dia. swivel casters with locks on the front set
- 1/6 size, 4" deep condiment pans included
- Door locks

■ **Optional features**

- Additional stainless steel shelf available
- Legs available for all models: 6"
- Casters available for this models: 1", 2.5", 5"
- Removable food cover
- Single and Double overshelf for only PST-60-08S-N(-LW)

PST MODELS SPECIFICATIONS

ELECTRICAL DATA	PST-48-08S-N(-LW)	PST-60-08S-N(-LW)
Voltage	115/60/1	115/60/1
Plug Type	Ⓢ NEMA 5-15P	Ⓢ NEMA 5-15P
Full Load Amp.	6.5	6.5
Compressor HP	1/5	1/5
Cord Length (ft.)	9	10
Refrigerant	R-290	R-290
DIMENSIONAL DATA		
Net Capacity (cu. ft.)	15	16
Ext. Dimension (L x D* x H†) (in.)	48 1/4 x 30 x 33 1/2	48 1/4 x 30 x 33 1/2
# of Doors	2	2
# of Shelves (Size (L x D) (in.))	2 (21 x 17)	2 (27 x 17)
# of Pans	8	8
Net Weight (lbs.)	259	278
Gross Weight (lbs.)	268	296

Design and specifications subject to change without notice. Most updated spec sheets are available at www.turboairinc.com.

Actual shipping weight may differ due to extra packing materials for product protection.

* Depth does not include 2" for door handles and rear spacers. † Height does not include 4-1/2" for caster height.

■ **WARRANTY: 5 Year Parts and Labor Warranty, 7 Year Compressor Warranty**

PREP TABLE + WORK STATIONS - CLEAR LID



Self-Cleaning Condenser Equipped Units

■ **Self-Cleaning Condenser (Patented)**

The accumulation of dust in the condenser can cause the failure or breakdown of refrigerators. Refrigerators run normally until they reach a certain level of accumulation. At some point, when they are over the limit, their performance drops quickly resulting in damage to, or disposal of the stored products inside. The Self-Cleaning Condenser device keeps the condenser clean and prevents system failure by automatically brushing daily.

■ **Digital temperature control & monitor system**

Keeps food products safe by maintaining constant temperatures. External digital display allows for easy monitoring.

■ **Hydrocarbon refrigerants (R-290)**

With innovative and eco-friendly technology, Turbo Air brings you hydrocarbon refrigerators designed to meet DOE's Energy Conservation Standards in 2017 and to use EPA's SNAP Program approved HC refrigerants. Hydrocarbon refrigerants do not deplete the ozone layer and have very low contribution to global warming (ODP-0, GWP-3).

■ **Cold Bunker system**

Our innovative forced air system allows cold air to flow all around the food pan area, covering not only underneath the pan, but also the front, top and the rear. This unique air flow creates a cold air-shield around the pan, which maintains the food temperature at under 41°F (NSF requirement) even when the lids are opened. In addition, the compartment isolates pans from the reach-in area to prevent food spillage.

■ **Stainless steel cabinet construction**

The PRO series model boasts a stainless steel interior and a 22 gauge stainless steel exterior (galvanized steel bottom). It guarantees the utmost in cleanliness and long product life. The PRO series adds a touch of style to the most refined setting.

■ **Sturdy, clean stainless steel shelving**

Shelves are the most important part of cleanliness as they come in direct contact with food. The PRO series uniquely provides stainless steel shelving.

■ **High-density polyurethane insulation**

The entire cabinet structure and solid doors are foamed-in-place using high density, CFC free polyurethane insulation.

■ **Spring assisted heavy duty gravity hinge**

■ **Easy removable hood & hood lid for cleaning**

■ **9-1/2" deep, 1/2" thick high-density Polyethylene cutting board included with convenient side rail**



Self-Cleaning Condenser
Maintenance-free during warranty period

LED interior lighting & fan control
Energy efficient LED lighting lights every corner, making items easy to find. Fan control function automatically shuts off the fan when the door is open, which prevents hot air from being drawn in, thus maintaining the cool inner temperature.

■ **Refrigerator holds 33°F ~ 39°F for the best in food preservation**

■ **Lifetime guaranteed heavy duty hinges and handles**

■ **Built to maintain NSF standard temperatures in 100°F ambient**

■ **Standard features**

- Anti-corrosion coated evaporator
- Self-contained system
- 4" dia. swivel casters with locks on the front set
- 1/6 size, 4" deep condiment pans included
- Door locks

■ **Optional features**

- Legs available for all models: 6"
- Casters available for this models: 1", 2.5", 5"
- Removable food cover
- Additional stainless steel shelf

PST-CL MODELS SPECIFICATIONS

ELECTRICAL DATA	PST-48-08S-N-CL	PST-60-08S-N-CL
Voltage	115/60/1	115/60/1
Plug Type	Ⓢ NEMA 5-15P	Ⓢ NEMA 5-15P
Full Load Amp.	6.5	8.9
Compressor HP	1/5	1/5
Cord Length (ft.)	9	9
Refrigerant	R-290	R-290
DIMENSIONAL DATA		
Net Capacity (cu. ft.)	15	16
Ext. Dimension (L x D [*] x H [†]) (in.)	48 1/4 x 30 x 37 5/8	60 1/4 x 30 x 37 5/8
# of Doors	2	2
# of Shelves (Size (L x D) (in.))	2 (21 x 17)	2 (27 x 17)
# of Pans	15	8
Net Weight (lbs.)	259	278
Gross Weight (lbs.)	275	309

Design and specifications subject to change without notice. Most updated spec sheets are available at www.turboairinc.com.

Actual shipping weight may differ due to extra packing materials for product protection.

* Depth does not include 2" for door handles and rear spacers. † Height does not include 4-1/2" for caster height.

■ **WARRANTY: 5 Year Parts and Labor Warranty, 7 Year Compressor Warranty**

PREP TABLE + WORK STATIONS - FLAT CLEAR LID



Self-Cleaning Condenser Equipped Units

■ **Self-Cleaning Condenser (Patented)**

The accumulation of dust in the condenser can cause the failure or breakdown of refrigerators. Refrigerators run normally until they reach a certain level of accumulation. At some point, when they are over the limit, their performance drops quickly resulting in damage to, or disposal of the stored products inside. The Self-Cleaning Condenser device keeps the condenser clean and prevents system failure by automatically brushing daily.

■ **Digital temperature control & monitor system**

Keeps food products safe by maintaining constant temperatures. External digital display allows for easy monitoring.

■ **Hydrocarbon refrigerants (R-290)**

With innovative and eco-friendly technology, Turbo Air brings you hydrocarbon refrigerators designed to meet DOE's Energy Conservation Standards in 2017 and to use EPA's SNAP Program approved HC refrigerants. Hydrocarbon refrigerants do not deplete the ozone layer and have very low contribution to global warming (ODP-0, GWP-3).

■ **Cold Bunker system**

Our innovative forced air system allows cold air to flow all around the food pan area, covering not only underneath the pan, but also the front, top and the rear. This unique air flow creates a cold air-shield around the pan, which maintains the food temperature at under 41°F (NSF requirement) even when the lids are opened. In addition, the compartment isolates pans from the reach-in area to prevent food spillage.

■ **Stainless steel cabinet construction**

The PRO series model boasts a stainless steel interior and a **22 gauge** stainless steel exterior (galvanized steel bottom). It guarantees the utmost in cleanliness and long product life. The PRO series adds a touch of style to the most refined setting.

■ **Sturdy, clean stainless steel shelving**

Shelves are the most important part of cleanliness as they come in direct contact with food. The PRO series uniquely provides stainless steel shelving.

■ **9-1/2" deep, 1/2" thick high-density Polyethylene cutting board included with convenient side rail**

■ **High-density polyurethane insulation**

The entire cabinet structure and solid doors are foamed-in-place using high density, CFC free polyurethane insulation.

■ **Spring assisted heavy duty gravity hinge**

■ **Refrigerator holds 33°F ~ 39°F for the best in food preservation**

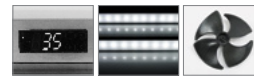

LED interior lighting & fan control

Energy efficient LED lighting lights every corner, making items easy to find. Fan control function automatically shuts off the fan when the door is open, which prevents hot air from being drawn in, thus maintaining the cool inner temperature.

■ **Lifetime guaranteed heavy duty hinges and handles**

■ **Built to maintain NSF standard temperatures in 100°F ambient**

■ **Standard features**

- Anti-corrosion coated evaporator
- Self-contained system
- 4" dia. swivel casters with locks on the front set
- 1/6 size, 4" deep condiment pans included
- Door locks

■ **Optional features**

- Additional stainless steel shelf available
- Legs available for all models: 6"
- Casters available for this models: 1", 2.5", 5"

PST-FL MODELS SPECIFICATIONS

ELECTRICAL DATA	PST-48-08S-N-FCL	PST-60-08S-N-FCL
Voltage	115/60/1	115/60/1
Plug Type	Ⓜ NEMA 5-15P	Ⓜ NEMA 5-15P
Full Load Amp.	6.5	6.5
Compressor HP	1/5	1/5
Cord Length (ft.)	9	9
Refrigerant	R-290	R-290
DIMENSIONAL DATA		
Net Capacity (cu. ft.)	15	15
Ext. Dimension (L x D* x H†) (in.)	48 1/4 x 30 x 33	48 1/4 x 30 x 33
# of Doors	2	2
# of Shelves (Size (L x D) (in.))	2 (21 x 17)	2 (27 x 17)
# of Pans	8	8
Net Weight (lbs.)	253	272
Gross Weight (lbs.)	269	303

Design and specifications subject to change without notice. Most updated spec sheets are available at www.turboairinc.com.

Actual shipping weight may differ due to extra packing materials for product protection.

* Depth does not include 2" for door handles and rear spacers. † Height does not include 4-1/2" for caster height.

■ **WARRANTY: 5 Year Parts and Labor Warranty, 7 Year Compressor Warranty**

PREP TABLE + WORK STATIONS - FLAT LID NATURAL Refrigerant

Self-Cleaning Condenser Equipped Units

Self-Cleaning Condenser (Patented)

The accumulation of dust in the condenser can cause the failure or breakdown of refrigerators. Refrigerators run normally until they reach a certain level of accumulation. At some point, when they are over the limit, their performance drops quickly resulting in damage to, or disposal of the stored products inside. The Self-Cleaning Condenser device keeps the condenser clean and prevents system failure by automatically brushing daily.

Digital temperature control & monitor system

Keeps food products safe by maintaining constant temperatures. External digital display allows for easy monitoring.

Hydrocarbon refrigerants (R-290)

With innovative and eco-friendly technology, Turbo Air brings you hydrocarbon refrigerators designed to meet DOE's Energy Conservation Standards in 2017 and to use EPA's SNAP Program approved HC refrigerants. Hydrocarbon refrigerants do not deplete the ozone layer and have very low contribution to global warming (ODP-0, GWP-3).

Cold Bunker system

Our innovative forced air system allows cold air to flow all around the food pan area, covering not only underneath the pan, but also the front, top and the rear. This unique air flow creates a cold air-shield around the pan, which maintains the food temperature at under 41°F (NSF requirement) even when the lids are opened. In addition, the compartment isolates pans from the reach-in area to prevent food spillage.

Stainless steel cabinet construction

The PRO series model boasts a stainless steel interior and a **22 gauge** stainless steel exterior (galvanized steel bottom). It guarantees the utmost in cleanliness and long product life. The PRO series adds a touch of style to the most refined setting.

Sturdy, clean stainless steel shelving

Shelves are the most important part of cleanliness as they come in direct contact with food. The PRO series uniquely provides stainless steel shelving.

9-1/2" deep, 1/2" thick high-density Polyethylene cutting board included with convenient side rail

High-density polyurethane insulation

The entire cabinet structure and solid doors are foamed-in-place using high density, CFC free polyurethane insulation.

Spring assisted heavy duty gravity hinge

Refrigerator holds 33°F ~ 39°F for the best in food preservation

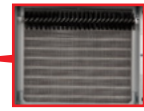

Self-Cleaning Condenser
Maintenance-free during warranty period

PST-48-08S-N-FL

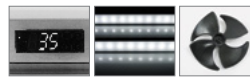

LED interior lighting & fan control

Energy efficient LED lighting lights every corner, making items easy to find. Fan control function automatically shuts off the fan when the door is open, which prevents hot air from being drawn in, thus maintaining the cool inner temperature.

Lifetime guaranteed heavy duty hinges and handles

Built to maintain NSF standard temperatures in 100°F ambient

Standard features

- Anti-corrosion coated evaporator
- Self-contained system
- 4" dia. swivel casters with locks on the front set
- 1/6 size, 4" deep condiment pans included
- Door locks

Optional features

- Additional stainless steel shelf available
- Legs available for all models: 6"
- Casters available for this models: 1", 2.5", 5"

PST-FL MODELS SPECIFICATIONS

ELECTRICAL DATA	PST-48-08S-N-FL	PST-60-08S-N-FL
Voltage	115/60/1	115/60/1
Plug Type	Ⓢ NEMA 5-15P	Ⓢ NEMA 5-15P
Full Load Amp.	6.5	8.9
Compressor HP	1/5	1/5
Cord Length (ft.)	10	9
Refrigerant	R-290	R-290
DIMENSIONAL DATA		
Net Capacity (cu. ft.)	15	16
Ext. Dimension (L x D [*] x H [†]) (in.)	48 ^{1/4} x 30 x 33 ^{1/2}	60 ^{1/4} x 30 x 33 ^{1/2}
# of Doors	2	2
# of Shelves (Size (L x D) (in.))	2 (21 x 17)	2 (27 x 17)
# of Pans	8	8
Net Weight (lbs.)	253	272
Gross Weight (lbs.)	269	303

Design and specifications subject to change without notice. Most updated spec sheets are available at www.turboairinc.com.

Actual shipping weight may differ due to extra packing materials for product protection.

* Depth does not include 2" for door handles and rear spacers. † Height does not include 4-1/2" for caster height.

WARRANTY: 5 Year Parts and Labor Warranty, 7 Year Compressor Warranty

MEGA TOP PREP TABLE+WORK STATIONS - CLEAR LID

NATURAL Refrigerant

Self-Cleaning Condenser Equipped Units

■ **Self-Cleaning Condenser (Patented)**

The accumulation of dust in the condenser can cause the failure or breakdown of refrigerators. Refrigerators run normally until they reach a certain level of accumulation. At some point, when they are over the limit, their performance drops quickly resulting in damage to, or disposal of the stored products inside. The Self-Cleaning Condenser device keeps the condenser clean and prevents system failure by automatically brushing daily.

■ **Digital temperature control & monitor system**

Keeps food products safe by maintaining constant temperatures. External digital display allows for easy monitoring.

■ **Hydrocarbon refrigerants (R-290)**

With innovative and eco-friendly technology, Turbo Air brings you hydrocarbon refrigerators designed to meet DOE's Energy Conservation Standards in 2017 and to use EPA's SNAP Program approved HC refrigerants. Hydrocarbon refrigerants do not deplete the ozone layer and have very low contribution to global warming (ODP-0, GWP-3).

■ **Cold Bunker system**

Our innovative forced air system allows cold air to flow all around the food pan area, covering not only underneath the pan, but also the front, top and the rear. This unique air flow creates a cold air-shield around the pan, which maintains the food temperature at under 41°F (NSF requirement) even when the lids are opened. In addition, the compartment isolates pans from the reach-in area to prevent food spillage.

■ **Stainless steel cabinet construction**

The PRO series model boasts a stainless steel interior and a **22 gauge** stainless steel exterior (galvanized steel bottom). It guarantees the utmost in cleanliness and long product life. The PRO series adds a touch of style to the most refined setting.

■ **Sturdy, clean stainless steel shelving**

Shelves are the most important part of cleanliness as they come in direct contact with food. The PRO series uniquely provides stainless steel shelving.

■ **High-density polyurethane insulation**

The entire cabinet structure and solid doors are foamed-in-place using high density, CFC free polyurethane insulation.

■ **Spring assisted heavy duty gravity hinge**

■ **Easy removable hood & hood lid for cleaning**

■ **9-1/2" deep, 1/2" thick high-density Polyethylene cutting board included with convenient side rail**



PST-60-12M-N-CL

PST-48-12M-N-CL

Self-Cleaning Condenser
Maintenance-free during warranty period



LED interior lighting & fan control

Energy efficient LED lighting lights every corner, making items easy to find. Fan control function automatically shuts off the fan when the door is open, which prevents hot air from being drawn in, thus maintaining the cool inner temperature.

■ **Refrigerator holds 33°F ~ 39°F for the best in food preservation**

■ **Lifetime guaranteed heavy duty hinges and handles**

■ **Built to maintain NSF standard temperatures in 100°F ambient**

■ **Standard features**

- Anti-corrosion coated evaporator
- Self-contained system
- 4" dia. swivel casters with locks on the front set
- 1/6 size, 4" deep condiment pans included
- Door locks

■ **Optional features**

- Legs available for all models: 6"
- Casters available for this models: 1", 2.5", 5"
- Removable food cover
- Single and double overshelf, stainless steel

PST-CL MODELS SPECIFICATIONS

ELECTRICAL DATA	PST-48-12M-N-CL	PST-60-12M-N-CL
Voltage	115/60/1	115/60/1
Plug Type	Ⓜ NEMA 5-15P	Ⓜ NEMA 5-15P
Full Load Amp.	6.5	8.9
Compressor HP	1/5	1/5
Cord Length (ft.)	9	9
Refrigerant	R-290	R-290
DIMENSIONAL DATA		
Net Capacity (cu. ft.)	15	19
Ext. Dimension (L x D* x H†) (in.)	48 1/4 x 34 x 39 5/8	60 1/4 x 34 x 39 5/8
# of Doors	2	2
# of Shelves (Size (L x D) (in.))	2 (21 x 17)	2 (27 x 17)
# of Pans	15	8
Net Weight (lbs.)	239	290
Gross Weight (lbs.)	269	335

Design and specifications subject to change without notice. Most updated spec sheets are available at www.turboairinc.com.

Actual shipping weight may differ due to extra packing materials for product protection.

* Depth does not include 3" for door handles and rear spacers. † Height does not include 4-1/2" for caster height.

■ **WARRANTY: 5 Year Parts and Labor Warranty, 7 Year Compressor Warranty**

MEGA TOP PREP TABLE + WORK STATIONS - FLAT CLEAR LID NATURAL Refrigerant

Self-Cleaning Condenser Equipped Units

■ **Self-Cleaning Condenser (Patented)**

The accumulation of dust in the condenser can cause the failure or breakdown of refrigerators. Refrigerators run normally until they reach a certain level of accumulation. At some point, when they are over the limit, their performance drops quickly resulting in damage to, or disposal of the stored products inside. The Self-Cleaning Condenser device keeps the condenser clean and prevents system failure by automatically brushing daily.

■ **Digital temperature control & monitor system**

Keeps food products safe by maintaining constant temperatures. External digital display allows for easy monitoring.

■ **Hydrocarbon refrigerants (R-290)**

With innovative and eco-friendly technology, Turbo Air brings you hydrocarbon refrigerators designed to meet DOE's Energy Conservation Standards in 2017 and to use EPA's SNAP Program approved HC refrigerants. Hydrocarbon refrigerants do not deplete the ozone layer and have very low contribution to global warming (ODP-0, GWP-3).

■ **Cold Bunker system**

Our innovative forced air system allows cold air to flow all around the food pan area, covering not only underneath the pan, but also the front, top and the rear. This unique air flow creates a cold air-shield around the pan, which maintains the food temperature at under 41°F (NSF requirement) even when the lids are opened. In addition, the compartment isolates pans from the reach-in area to prevent food spillage.

■ **Stainless steel cabinet construction**

The PRO series model boasts a stainless steel interior and a **22 gauge** stainless steel exterior (galvanized steel bottom). It guarantees the utmost in cleanliness and long product life. The PRO series adds a touch of style to the most refined setting.

■ **Sturdy, clean stainless steel shelving**

Shelves are the most important part of cleanliness as they come in direct contact with food. The PRO series uniquely provides stainless steel shelving.

■ **9-1/2" deep, 1/2" thick high-density Polyethylene cutting board included with convenient side rail**

■ **High-density polyurethane insulation**

The entire cabinet structure and solid doors are foamed-in-place using high density, CFC free polyurethane insulation.

■ **Spring assisted heavy duty gravity hinge**

■ **Refrigerator holds 33°F ~ 39°F for the best in food preservation**



PST-48-12M-N-FCL

PST-60-12M-N-FCL

Self-Cleaning Condenser
Maintenance-free
during warranty period

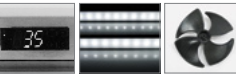

LED interior lighting & fan control

Energy efficient LED lighting lights every corner, making items easy to find. Fan control function automatically shuts off the fan when the door is open, which prevents hot air from being drawn in, thus maintaining the cool inner temperature.

■ **Lifetime guaranteed heavy duty hinges and handles**

■ **Built to maintain NSF standard temperatures in 100°F ambient**

■ **Standard features**

- Anti-corrosion coated evaporator
- Self-contained system
- 4" dia. swivel casters with locks on the front set
- 1/6 size, 4" deep condiment pans included
- Door locks

■ **Optional features**

- Additional stainless steel shelf available
- Legs available for all models: 6"
- Casters available for this models: 1", 2.5", 5"

PST-FCL MODELS SPECIFICATIONS

ELECTRICAL DATA	PST-48-12M-N-FCL	PST-60-12M-N-FCL
Voltage	115/60/1	115/60/1
Plug Type	Ⓢ NEMA 5-15P	Ⓢ NEMA 5-15P
Full Load Amp.	6.5	8.9
Compressor HP	1/5	1/5
Cord Length (ft.)	9	9
Refrigerant	R-290	R-290
DIMENSIONAL DATA		
Net Capacity (cu. ft.)	15	19
Ext. Dimension (L x D* x H†) (in.)	48 1/4 x 34 x 33 1/8	60 1/4 x 34 x 33 1/8
# of Doors	2	2
# of Shelves (Size (L x D) (in.))	2 (21 x 17)	2 (27 x 17)
# of Pans	8	12
Net Weight (lbs.)	239	284
Gross Weight (lbs.)	269	329

Design and specifications subject to change without notice. Most updated spec sheets are available at www.turboairinc.com.

Actual shipping weight may differ due to extra packing materials for product protection.

* Depth does not include 3" for door handles and rear spacers. † Height does not include 4-1/2" for caster height.

■ **WARRANTY: 5 Year Parts and Labor Warranty, 7 Year Compressor Warranty**

MEGA TOP PREP TABLE + WORK STATIONS NATURAL Refrigerant

Self-Cleaning Condenser Equipped Units

■ **Self-Cleaning Condenser (Patented)**

The accumulation of dust in the condenser can cause the failure or breakdown of refrigerators. Refrigerators run normally until they reach a certain level of accumulation. At some point, when they are over the limit, their performance drops quickly resulting in damage to, or disposal of the stored products inside. The Self-Cleaning Condenser device keeps the condenser clean and prevents system failure by automatically brushing daily.

■ **Digital temperature control & monitor system**

Keeps food products safe by maintaining constant temperatures. External digital display allows for easy monitoring.

■ **Hydrocarbon refrigerants (R-290)**

With innovative and eco-friendly technology, Turbo Air brings you hydrocarbon refrigerators designed to meet DOE's Energy Conservation Standards in 2017 and to use EPA's SNAP Program approved HC refrigerants. Hydrocarbon refrigerants do not deplete the ozone layer and have very low contribution to global warming (ODP-0, GWP-3).

■ **Cold Bunker system**

Our innovative forced air system allows cold air to flow all around the food pan area, covering not only underneath the pan, but also the front, top and the rear. This unique air flow creates a cold air-shield around the pan, which maintains the food temperature at under 41°F (NSF requirement) even when the lids are opened. In addition, the compartment isolates pans from the reach-in area to prevent food spillage.

■ **Stainless steel cabinet construction**

The PRO series model boasts a stainless steel interior and a **22 gauge** stainless steel exterior (galvanized steel bottom). It guarantees the utmost in cleanliness and long product life. The PRO series adds a touch of style to the most refined setting.

■ **Sturdy, clean stainless steel shelving**

Shelves are the most important part of cleanliness as they come in direct contact with food. The PRO series uniquely provides stainless steel shelving.

■ **9-1/2" deep, 1/2" thick high-density Polyethylene cutting board included with convenient side rail**

■ **High-density polyurethane insulation**

The entire cabinet structure and solid doors are foamed-in-place using high density, CFC free polyurethane insulation.

■ **Spring assisted heavy duty gravity hinge**

■ **Refrigerator holds 33°F ~ 39°F for the best in food preservation**



PST-48-12M-N-FL

PST-60-12M-N-FL

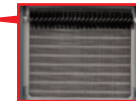
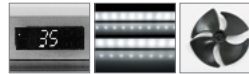

Self-Cleaning Condenser
Maintenance-free during warranty period

LED interior lighting & fan control

Energy efficient LED lighting lights every corner, making items easy to find. Fan control function automatically shuts off the fan when the door is open, which prevents hot air from being drawn in, thus maintaining the cool inner temperature.

■ **Lifetime guaranteed heavy duty hinges and handles**

■ **Built to maintain NSF standard temperatures in 100°F ambient**

■ **Standard features**

- Anti-corrosion coated evaporator
- Self-contained system
- 4" dia. swivel casters with locks on the front set
- 1/6 size, 4" deep condiment pans included
- Door locks

■ **Optional features**

- Additional stainless steel shelf available
- Legs available for all models: 6"
- Casters available for this models: 1", 2.5", 5"
- Removable food cover
- Single and Double overshelf, stainless steel

PST MODELS SPECIFICATIONS

ELECTRICAL DATA	PST-48-12M-N-FL	PST-60-12M-N-FL
Voltage	115/60/1	115/60/1
Plug Type	Ⓢ NEMA 5-15P	Ⓢ NEMA 5-15P
Full Load Amp.	6.5	8.9
Compressor HP	1/5	1/5
Cord Length (ft.)	9	9
Refrigerant	R-290	R-290
DIMENSIONAL DATA		
Net Capacity (cu. ft.)	15	19
Ext. Dimension (L x D* x H†) (in.)	48 1/4 x 34 x 33 1/2	60 1/4 x 34 x 33 1/2
# of Doors	2	2
# of Shelves (Size (L x D) (in.))	2 (21 x 17)	2 (27 x 17)
# of Pans	12	12
Net Weight (lbs.)	233	284
Gross Weight (lbs.)	263	329

Design and specifications subject to change without notice. Most updated spec sheets are available at www.turboairinc.com.

Actual shipping weight may differ due to extra packing materials for product protection.

* Depth does not include 3" for door handles and rear spacers. † Height does not include 4-1/2" for caster height.

■ **WARRANTY: 5 Year Parts and Labor Warranty, 7 Year Compressor Warranty**

MEGA TOP PREP TABLE+WORK STATIONS NATURAL Refrigerant

Self-Cleaning Condenser Equipped Units

■ **Self-Cleaning Condenser (Patented)**

The accumulation of dust in the condenser can cause the failure or breakdown of refrigerators. Refrigerators run normally until they reach a certain level of accumulation. At some point, when they are over the limit, their performance drops quickly resulting in damage to, or disposal of the stored products inside. The Self-Cleaning Condenser device keeps the condenser clean and prevents system failure by automatically brushing daily.

■ **Digital temperature control & monitor system**

Keeps food products safe by maintaining constant temperatures. External digital display allows for easy monitoring.

■ **Hydrocarbon refrigerants (R-290)**

With innovative and eco-friendly technology, Turbo Air brings you hydrocarbon refrigerators designed to meet DOE's Energy Conservation Standards in 2017 and to use EPA's SNAP Program approved HC refrigerants. Hydrocarbon refrigerants do not deplete the ozone layer and have very low contribution to global warming (ODP-0, GWP-3).

■ **Cold Bunker system**

Our innovative forced air system allows cold air to flow all around the food pan area, covering not only underneath the pan, but also the front, top and the rear. This unique air flow creates a cold air-shield around the pan, which maintains the food temperature at under 41°F (NSF requirement) even when the lids are opened. In addition, the compartment isolates pans from the reach-in area to prevent food spillage.

■ **Stainless steel cabinet construction**

The PRO series model boasts a stainless steel interior and a 22 gauge stainless steel exterior (galvanized steel bottom). It guarantees the utmost in cleanliness and long product life. The PRO series adds a touch of style to the most refined setting.

■ **Sturdy, clean stainless steel shelving**

Shelves are the most important part of cleanliness as they come in direct contact with food. The PRO series uniquely provides stainless steel shelving.

■ **9-1/2" deep, 1/2" thick high-density Polyethylene cutting board included with convenient side rail**

■ **High-density polyurethane insulation**

The entire cabinet structure and solid doors are foamed-in-place using high density, CFC free polyurethane insulation.

■ **Spring assisted heavy duty gravity hinge**

■ **Easy removable hood & hood lid for cleaning**

■ **Insulated hood & hood lid**



PST-48-12M-N-LW

PST-60-12M-N

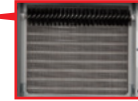
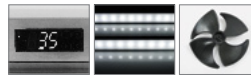

Self-Cleaning Condenser
Maintenance-free during warranty period

LED interior lighting & fan control

Energy efficient LED lighting lights every corner, making items easy to find. Fan control function automatically shuts off the fan when the door is open, which prevents hot air from being drawn in, thus maintaining the cool inner temperature.

■ **Refrigerator holds 33°F ~ 39°F for the best in food preservation**

■ **Lifetime guaranteed heavy duty hinges and handles**

■ **Built to maintain NSF standard temperatures in 100°F ambient**

■ **Standard features**

- Anti-corrosion coated evaporator
- Self-contained system
- 4" dia. swivel casters with locks on the front set
- 1/6 size, 4" deep condiment pans included
- Door locks

■ **Optional features**

- Additional stainless steel shelf available
- Legs available for all models: 6"
- Casters available for this models: 1", 2.5", 5"
- Removable food cover
- Single and Double overshef, stainless steel

PST MODELS SPECIFICATIONS

ELECTRICAL DATA	PST-48-12M-N(-LW)	PST-60-12M-N(-LW)
Voltage	115/60/1	115/60/1
Plug Type	Ⓢ NEMA 5-15P	Ⓢ NEMA 5-15P
Full Load Amp.	6.5	8.9
Compressor HP	1/5	1/5
Cord Length (ft.)	9	9
Refrigerant	R-290	R-290
DIMENSIONAL DATA		
Net Capacity (cu. ft.)	15	19
Ext. Dimension (L x D [*] x H [†]) (in.)	48 ^{1/4} x 34 x 39 ^{5/8}	60 ^{1/4} x 34 x 39 ^{5/8}
# of Doors	2	2
# of Shelves (Size (L x D) (in.))	2 (21 x 17)	2 (27 x 17)
# of Pans	12	12
Net Weight (lbs.)	239	290
Gross Weight (lbs.)	256	322

Design and specifications subject to change without notice. Most updated spec sheets are available at www.turboairinc.com.

Actual shipping weight may differ due to extra packing materials for product protection.

* Depth does not include 3" for door handles and rear spacers. † Height does not include 5" for caster height.

■ **WARRANTY: 5 Year Parts and Labor Warranty, 7 Year Compressor Warranty**

SANDWICH/SALAD UNITS - FRONT BREATHING AIRFLOW NATURAL Refrigerant

Self-Cleaning Condenser Equipped Units

■ **Self-Cleaning Condenser (Patented)**

The accumulation of dust in the condenser can cause the failure or breakdown of refrigerators. Refrigerators run normally until they reach a certain level of accumulation. At some point, when they are over the limit, their performance drops quickly resulting in damage to, or disposal of the stored products inside. The Self-Cleaning Condenser device keeps the condenser clean and prevents system failure by automatically brushing daily.

■ **Digital temperature control & monitor system**

Keeps food products safe by maintaining constant temperatures. External digital display allows for easy monitoring.

■ **Front Breathing airflow**

Front Breathing airflow is designed to draw in air and discharge from the front, allowing units to run at high efficiency in tight spaces and eliminates the need for surrounding clearances.

■ **Hydrocarbon refrigerants (R-290)**

With innovative and eco-friendly technology, Turbo Air brings you hydrocarbon refrigerators designed to meet DOE's Energy Conservation Standards in 2017 and to use EPA's SNAP Program approved HC refrigerants. Hydrocarbon refrigerants do not deplete the ozone layer and have very low contribution to global warming (ODP-0, GWP-3).

■ **Stainless steel cabinet construction**

The PRO series model boasts a stainless steel interior and a **22 gauge** stainless steel exterior (galvanized steel bottom). It guarantees the utmost in cleanliness and long product life. The PRO series adds a touch of style to the most refined setting.

■ **Sturdy, clean stainless steel shelving**

Shelves are the most important part of cleanliness as they come in direct contact with food. The PRO series uniquely provides stainless steel shelving.

■ **9-1/2" deep, 1/2" thick high-density Polyethylene cutting board included with convenient side rail**

■ **Left hinged model available (PST-28-FB-N-L)**

■ **Spring assisted heavy duty gravity hinge**

■ **Easy removal hood & hood lid for cleaning**

■ **Insulated hood & hood lid**

■ **Refrigerator holds 33°F ~ 39°F for the best in food preservation**

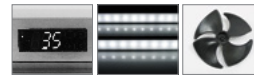

LED interior lighting & fan control

Energy efficient LED lighting lights every corner, making items easy to find. Fan control function automatically shuts off the fan when the door is open, which prevents hot air from being drawn in, thus maintaining the cool inner temperature.

■ **Standard features**

- Anti-corrosion coated evaporator
- Self-contained system
- 4" dia. swivel casters with locks on the front set
- 1/6 size, 4" deep condiment pans included
- Door locks
- High-density polyurethane insulation
- Lead time applies

■ **Optional features**

- Stainless steel single/double overshelf available (except PST-28-FB-N)
- Removable food covers available
- Legs available for all models: 6"
- Casters available for all models: 1" (1.5" low profile caster kit for PST-28-FB-N), 2.5" (except PST-28-FB-N), 5"

PST MODELS SPECIFICATIONS

ELECTRICAL DATA	PST-28-FB-N	PST-48-FB-N	PST-60-FB-N	PST-72-FB-N
Voltage	115/60/1	115/60/1	115/60/1	115/60/1
Plug Type	Ⓜ NEMA 5-15P	Ⓜ NEMA 5-15P	Ⓜ NEMA 5-15P	Ⓜ NEMA 5-15P
Full Load Amp.	3.8	4.4	4.4	5.7
Compressor HP	1/5	1/3	1/3	2/5
Cord Length (ft.)	10	10	10	10
Refrigerant	R-290	R-290	R-290	R-290
DIMENSIONAL DATA				
Net Capacity (cu. ft.)	6.5	11.1	14.8	17.6
Ext. Dimension (L x D* x H†) (in.)	27 1/2 x 30 x 37 5/8	48 1/4 x 30 x 37 5/8	60 1/4 x 30 x 37 5/8	72 5/8 x 30 x 37 5/8
# of Doors	1	2	2	2
# of Shelves (Size (L x D) (in.))	1 (22 1/2 x 17)	2 (21 x 17)	2 (27 x 17)	2 (33 1/8 x 17)
# of Pans	8	12	16	18
Net Weight (lbs.)	170	234	284	344
Gross Weight (lbs.)	195	273	316	372

Design and specifications subject to change without notice. Most updated spec sheets are available at www.turboairinc.com.

Actual shipping weight may differ due to extra packing materials for product protection.

* Depth does not include 3/4" for door handles. † Height does not include 4-1/2" for caster height.

■ **WARRANTY: 5 Year Parts and Labor Warranty, 7 Year Compressor Warranty**

SANDWICH/SALAD UNITS - FRONT BREATHING AIRFLOW/DRAWERS

Self-Cleaning Condenser Equipped Units

■ **Self-Cleaning Condenser (Patented)**

The accumulation of dust in the condenser can cause the failure or breakdown of refrigerators. Refrigerators run normally until they reach a certain level of accumulation. At some point, when they are over the limit, their performance drops quickly resulting in damage to, or disposal of the stored products inside. The Self-Cleaning Condenser device keeps the condenser clean and prevents system failure by automatically brushing daily.

■ **Digital temperature control & monitor system**

Keeps food products safe by maintaining constant temperatures. External digital display allows for easy monitoring.

■ **Front Breathing airflow**

Front Breathing airflow is designed to draw in air and discharge from the front, allowing units to run at high efficiency in tight spaces and eliminates the need for surrounding clearances.

■ **Hydrocarbon refrigerants (R-290)**

With innovative and eco-friendly technology, Turbo Air brings you hydrocarbon refrigerators designed to meet DOE's Energy Conservation Standards in 2017 and to use EPA's SNAP Program approved HC refrigerants. Hydrocarbon refrigerants do not deplete the ozone layer and have very low contribution to global warming (ODP-0, GWP-3).

■ **Stainless steel cabinet construction**

The PRO series model boasts a stainless steel interior and a **22 gauge** stainless steel exterior (galvanized steel bottom). It guarantees the utmost in cleanliness and long product life. The PRO series adds a touch of style to the most refined setting.

■ **Sturdy, clean stainless steel shelving**

Shelves are the most important part of cleanliness as they come in direct contact with food. The PRO series uniquely provides stainless steel shelving (only PST-48-D2R(L)-FB-N).

■ **9-1/2" deep, 1/2" thick high-density Polyethylene cutting board included with convenient side rail**

■ **Spring assisted heavy duty gravity hinge (only PST-48-D2R(L)-FB-N)**

■ **Easy removal hood & hood lid for cleaning**

■ **Insulated hood & hood lid**

■ **Refrigerator holds 33°F ~ 39°F for the best in food preservation**



PST-48-D2R-FB-N

Self-Cleaning Condenser
Maintenance-free during warranty period

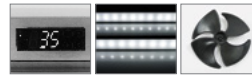

LED interior lighting & fan control

Energy efficient LED lighting lights every corner, making items easy to find. Fan control function automatically shuts off the fan when the door is open, which prevents hot air from being drawn in, thus maintaining the cool inner temperature (only PST-48-D2R(L)-FB-N).

■ **Standard features**

- Anti-corrosion coated evaporator
- Self-contained system
- High-density polyurethane insulation
- 4" dia. swivel casters with locks on the front set
- 1/6 size, 4" deep condiment pans included (top of cabinet)
- Drawers accommodate 6" deep pans (pans not included)
- Door locks (only PST-48-D2R(L)-FB-N)
- Lead time applies

■ **Optional features**

- Stainless steel single/double overshelf available (except PST-28-D2-FB-N)
- Removable food covers available
- Legs available for all models: 6"
- Casters available for all models: 1" (1.5" low profile caster kit for PST-28-D2-FB-N), 2.5" (except PST-28-D2-FB-N), 5"

PST MODELS SPECIFICATIONS

ELECTRICAL DATA	PST-28-D2-FB-N	PST-48-D2R(L)-FB-N	PST-48-D4-FB-N
Voltage	115/60/1	115/60/1	115/60/1
Plug Type	Ⓢ NEMA 5-15P	Ⓢ NEMA 5-15P	Ⓢ NEMA 5-15P
Full Load Amp.	6.6	6.5	6.5
Compressor HP	1/6	1/5	1/5
Cord Length (ft.)	10	10	10
Refrigerant	R-290	R-290	R-290
DIMENSIONAL DATA			
Net Capacity (cu. ft.)	6.5	11.1	11.1
Ext. Dimension (L x D* x H†) (in.)	27 ¹ / ₂ x 30 x 37 ⁵ / ₈	48 ¹ / ₄ x 30 x 37 ⁵ / ₈	48 ¹ / ₄ x 30 x 37 ⁵ / ₈
# of Doors	-	1	-
# of Drawers	2	2	4
# of Shelves (Size (L x D) (in.))	-	1 (21 x 17)	-
# of Pans	8	12	12
Net Weight (lbs.)	210	260	276
Gross Weight (lbs.)	216	266	282

Design and specifications subject to change without notice. Most updated spec sheets are available at www.turboairinc.com.

Actual shipping weight may differ due to extra packing materials for product protection.

* Depth does not include 7/8" for door handles. † Height does not include 4-1/2" for caster height.

■ **WARRANTY: 5 Year Parts and Labor Warranty, 7 Year Compressor Warranty**

SANDWICH/SALAD UNITS - FRONT BREATHING AIRFLOW/DRAWERS

Self-Cleaning Condenser Equipped Units

- **Self-Cleaning Condenser (Patented)**
The accumulation of dust in the condenser can cause the failure or breakdown of refrigerators. Refrigerators run normally until they reach a certain level of accumulation. At some point, when they are over the limit, their performance drops quickly resulting in damage to, or disposal of the stored products inside. The Self-Cleaning Condenser device keeps the condenser clean and prevents system failure by automatically brushing daily.
- **Digital temperature control & monitor system**
Keeps food products safe by maintaining constant temperatures. External digital display allows for easy monitoring.
- **Front Breathing airflow**
Front Breathing airflow is designed to draw in air and discharge from the front, allowing units to run at high efficiency in tight spaces and eliminates the need for surrounding clearances.
- **Hydrocarbon refrigerants (R-290)**
With innovative and eco-friendly technology, Turbo Air brings you hydrocarbon refrigerators designed to meet DOE's Energy Conservation Standards in 2017 and to use EPA's SNAP Program approved HC refrigerants. Hydrocarbon refrigerants do not deplete the ozone layer and have very low contribution to global warming (ODP-0, GWP-3).
- **Stainless steel cabinet construction**
The PRO series model boasts a stainless steel interior and a **22 gauge** stainless steel exterior (galvanized steel bottom). It guarantees the utmost in cleanliness and long product life. The PRO series adds a touch of style to the most refined setting.
- **Sturdy, clean stainless steel shelving**
Shelves are the most important part of cleanliness as they come in direct contact with food. The PRO series uniquely provides stainless steel shelving (only PST-60-D2R(L)-FB-N, PST-72-D2R(L)-FB-N).
- **9-1/2" deep, 1/2" thick high-density Polyethylene cutting board included with convenient side rail**
- **Spring assisted heavy duty gravity hinge (only PST-60-D2R(L)-FB-N, PST-72-D2R(L)-FB-N)**
- **Easy removal hood & hood lid for cleaning**
- **Insulated hood & hood lid**
- **Refrigerator holds 33°F ~ 39°F for the best in food preservation**

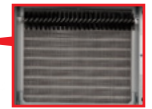

Self-Cleaning Condenser
Maintenance-free during warranty period

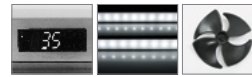

LED interior lighting & fan control

Energy efficient LED lighting lights every corner, making items easy to find. Fan control function automatically shuts off the fan when the door is open, which prevents hot air from being drawn in, thus maintaining the cool inner temperature (only PST-60-D2R(L)-FB-N, PST-72-D2R(L)-FB-N).

■ **Standard features**

- Anti-corrosion coated evaporator
- Self-contained system
- 4" dia. swivel casters with locks on the front set
- 1/6 size, 4" deep condiment pans included (top of cabinet)
- Drawers accommodate 6" deep pans (pans not included)
- Door locks (only PST-60-D2R(L)-FB-N, PST-72-D2R(L)-FB-N)
- High-density polyurethane insulation
- Lead time applies

■ **Optional features**

- Stainless steel single/double overs shelf available
- Removable food covers available
- Legs available for all models: 6"
- Casters available for all models: 1", 2.5", 5"

PST MODELS SPECIFICATIONS

ELECTRICAL DATA	PST-60-D2R(L)-FB-N	PST-60-D4-FB-N	PST-72-D2R(L)-FB-N	PST-72-D4-FB-N
Voltage	115/60/1	115/60/1	115/60/1	115/60/1
Plug Type	Ⓢ NEMA 5-15P	Ⓢ NEMA 5-15P	Ⓢ NEMA 5-15P	Ⓢ NEMA 5-15P
Full Load Amp.	8.9	8.9	9.9	9.9
Compressor HP	1/5	1/5	3/8	3/8
Cord Length (ft.)	10	10	10	10
Refrigerant	R-290	R-290	R-290	R-290
DIMENSIONAL DATA				
Net Capacity (cu. ft.)	14.8	14.8	17.6	17.6
Ext. Dimension (L x D x H†) (in.)	60 ^{1/4} x 30 x 37 ^{5/8}	60 ^{1/4} x 30 x 37 ^{5/8}	72 ^{5/8} x 30 x 37 ^{5/8}	72 ^{5/8} x 30 x 37 ^{5/8}
# of Doors	1	-	1	-
# of Drawers	2	4	2	4
# of Shelves (Size (L x D) (in.))	1 (27 x 17)	-	1 (33 ^{1/8} x 17)	-
# of Pans	16	16	18	18
Net Weight (lbs.)	332	364	378	384
Gross Weight (lbs.)	338	371	382	395

Design and specifications subject to change without notice. Most updated spec sheets are available at www.turboairinc.com.

Actual shipping weight may differ due to extra packing materials for product protection.

* Depth does not include 7/8" for door handles. † Height does not include 4-1/2" for caster height.

- **WARRANTY: 5 Year Parts and Labor Warranty, 7 Year Compressor Warranty**

MEGA TOP UNITS-FRONT BREATHING AIRFLOW NATURAL Refrigerant

Self-Cleaning Condenser Equipped Units

■ **Self-Cleaning Condenser (Patented)**

The accumulation of dust in the condenser can cause the failure or breakdown of refrigerators. Refrigerators run normally until they reach a certain level of accumulation. At some point, when they are over the limit, their performance drops quickly resulting in damage to, or disposal of the stored products inside. The Self-Cleaning Condenser device keeps the condenser clean and prevents system failure by automatically brushing daily.

■ **Digital temperature control & monitor system**

Keeps food products safe by maintaining constant temperatures. External digital display allows for easy monitoring.

■ **Front Breathing airflow**

Front Breathing airflow is designed to draw in air and discharge from the front, allowing units to run at high efficiency in tight spaces and eliminates the need for surrounding clearances.

■ **Hydrocarbon refrigerants (R-290)**

With innovative and eco-friendly technology, Turbo Air brings you hydrocarbon refrigerators designed to meet DOE's Energy Conservation Standards in 2017 and to use EPA's SNAP Program approved HC refrigerants. Hydrocarbon refrigerants do not deplete the ozone layer and have very low contribution to global warming (ODP-0, GWP-3).

■ **Stainless steel cabinet construction**

The PRO series model boasts a stainless steel interior and a **22 gauge** stainless steel exterior (galvanized steel bottom). It guarantees the utmost in cleanliness and long product life. The PRO series adds a touch of style to the most refined setting.

■ **Sturdy, clean stainless steel shelving**

Shelves are the most important part of cleanliness as they come in direct contact with food. The PRO series uniquely provides stainless steel shelving.

■ **9-1/2" deep, 1/2" thick high-density Polyethylene cutting board included with convenient side rail**

■ **Left hinged model available (PST-28-12-FB-N-L)**

■ **Spring assisted heavy duty gravity hinge**

■ **Easy removal hood & hood lid for cleaning**

■ **Insulated hood & hood lid**



PST-48-18-FB-N

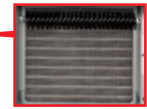

Self-Cleaning Condenser
Maintenance-free during warranty period

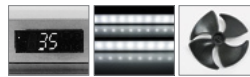

LED interior lighting & fan control

Energy efficient LED lighting lights every corner, making items easy to find. Fan control function automatically shuts off the fan when the door is open, which prevents hot air from being drawn in, thus maintaining the cool inner temperature.

■ **Refrigerator holds 33°F ~ 39°F for the best in food preservation**

■ **Standard features**

- Anti-corrosion coated evaporator
- Self-contained system
- 4" dia. swivel casters with locks on the front set
- 1/6 size, 4" deep condiment pans included
- Door locks
- High-density polyurethane insulation
- Lead time applies

■ **Optional features**

- Stainless steel single/double overshef available (except PST-28-12-FB-N)
- Removable food covers available
- Legs available for all models: 6"
- Casters available for all models: 1" (1.5" low profile caster kit for PST-28-12-FB-N), 2.5" (except PST-28-12-FB-N), 5"

PST MODELS SPECIFICATIONS

ELECTRICAL DATA	PST-28-12-FB-N	PST-48-18-FB-N	PST-60-24-FB-N	PST-72-30-FB-N
Voltage	115/60/1	115/60/1	115/60/1	115/60/1
Plug Type	Ⓜ NEMA 5-15P	Ⓜ NEMA 5-15P	Ⓜ NEMA 5-15P	Ⓜ NEMA 5-15P
Full Load Amp.	3.8	6.5	4.4	5.7
Compressor HP	1/5	1/5	1/3	2/5
Cord Length (ft.)	10	10	10	10
Refrigerant	R-290	R-290	R-290	R-290
DIMENSIONAL DATA				
Net Capacity (cu. ft.)	6.5	11.1	14.8	17.6
Ext. Dimension (L x D x H†) (in.)	27 1/2 x 34 x 39 5/8	48 1/4 x 34 x 39 5/8	60 1/4 x 34 x 39 5/8	72 5/8 x 34 x 39 5/8
# of Doors	1	2	2	2
# of Shelves (Size (L x D) (in.))	1 (22 1/2 x 17)	2 (21 x 17)	2 (27 x 17)	2 (33 1/8 x 17)
# of Pans	12	18	24	30
Net Weight (lbs.)	216	256	337	374
Gross Weight (lbs.)	220	264	352	396

Design and specifications subject to change without notice. Most updated spec sheets are available at www.turboairinc.com.

Actual shipping weight may differ due to extra packing materials for product protection.

* Depth does not include 3" for cutting boards. † Height does not include 4-1/2" for caster height.

■ **WARRANTY: 5 Year Parts and Labor Warranty, 7 Year Compressor Warranty**

MEGA TOP UNITS - FRONT BREATHING AIRFLOW/GLASS LID

Self-Cleaning Condenser Equipped Units

Self-Cleaning Condenser (Patented)

The accumulation of dust in the condenser can cause the failure or breakdown of refrigerators. Refrigerators run normally until they reach a certain level of accumulation. At some point, when they are over the limit, their performance drops quickly resulting in damage to, or disposal of the stored products inside. The Self-Cleaning Condenser device keeps the condenser clean and prevents system failure by automatically brushing daily.

Digital temperature control & monitor system

Keeps food products safe by maintaining constant temperatures. External digital display allows for easy monitoring.

Front Breathing airflow

Front Breathing airflow is designed to draw in air and discharge from the front, allowing units to run at high efficiency in tight spaces and eliminates the need for surrounding clearances.

Hydrocarbon refrigerants (R-290)

With innovative and eco-friendly technology, Turbo Air brings you hydrocarbon refrigerators designed to meet DOE's Energy Conservation Standards in 2017 and to use EPA's SNAP Program approved HC refrigerants. Hydrocarbon refrigerants do not deplete the ozone layer and have very low contribution to global warming (ODP-0, GWP-3).

Stainless steel cabinet construction

The PRO series model boasts a stainless steel interior and a 22 gauge stainless steel exterior (galvanized steel bottom). It guarantees the utmost in cleanliness and long product life. The PRO series adds a touch of style to the most refined setting.

Sturdy, clean stainless steel shelving

Shelves are the most important part of cleanliness as they come in direct contact with food. The PRO series uniquely provides stainless steel shelving.

6-1/4" deep, 1/2" thick high-density Polyethylene cutting board included with convenient side rail

Spring assisted heavy duty gravity hinge

Refrigerator holds 33°F ~ 39°F for the best in food preservation



PST-60-24-FB-N-GL

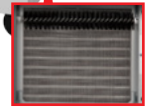

Self-Cleaning Condenser
Maintenance-free during warranty period



LED interior lighting & fan control

Energy efficient LED lighting lights every corner, making items easy to find. Fan control function automatically shuts off the fan when the door is open, which prevents hot air from being drawn in, thus maintaining the cool inner temperature.

Standard features

- Anti-corrosion coated evaporator
- Self-contained system
- 4" dia. swivel casters with locks on the front set
- 1/6 size, 4" deep condiment pans included
- Door locks
- High-density polyurethane insulation
- Lead time applies

Optional features

- Legs available for all models: 6"
- Casters available for all models: 1", 2.5", 5"

PST MODELS SPECIFICATIONS

ELECTRICAL DATA	PST-48-18-FB-N-GL	PST-60-24-FB-N-GL
Voltage	115/60/1	115/60/1
Plug Type	Ⓢ NEMA 5-15P	Ⓢ NEMA 5-15P
Full Load Amp.	6.5	8.9
Compressor HP	1/5	1/5
Cord Length (ft.)	10	10
Refrigerant	R-290	R-290
DIMENSIONAL DATA		
Net Capacity (cu. ft.)	11.1	14.8
Ext. Dimension (L x D [†] x H [†]) (in.)	48 ^{1/4} x 34 ^{5/8} x 32 ^{5/8}	60 ^{1/4} x 34 ^{5/8} x 32 ^{5/8}
# of Doors	2	2
# of Shelves (Size (L x D) (in.))	2 (21 x 17)	2 (27 x 17)
# of Pans	18	24
Net Weight (lbs.)	244	294
Gross Weight (lbs.)	283	326

Design and specifications subject to change without notice. Most updated spec sheets are available at www.turboairinc.com.

Actual shipping weight may differ due to extra packing materials for product protection.

* Depth does not include 1" for cutting boards. † Height does not include 4-1/2" for caster height.

WARRANTY: 5 Year Parts and Labor Warranty, 7 Year Compressor Warranty

MEGA TOP UNITS - FRONT BREATHING AIRFLOW/DRAWERS NATURAL Refrigerant

Self-Cleaning Condenser Equipped Units

■ **Self-Cleaning Condenser (Patented)**

The accumulation of dust in the condenser can cause the failure or breakdown of refrigerators. Refrigerators run normally until they reach a certain level of accumulation. At some point, when they are over the limit, their performance drops quickly resulting in damage to, or disposal of the stored products inside. The Self-Cleaning Condenser device keeps the condenser clean and prevents system failure by automatically brushing daily.

■ **Digital temperature control & monitor system**

Keeps food products safe by maintaining constant temperatures. External digital display allows for easy monitoring.

■ **Front Breathing airflow**

Front Breathing airflow is designed to draw in air and discharge from the front, allowing units to run at high efficiency in tight spaces and eliminates the need for surrounding clearances.

■ **Hydrocarbon refrigerants (R-290)**

With innovative and eco-friendly technology, Turbo Air brings you hydrocarbon refrigerators designed to meet DOE's Energy Conservation Standards in 2017 and to use EPA's SNAP Program approved HC refrigerants. Hydrocarbon refrigerants do not deplete the ozone layer and have very low contribution to global warming (ODP-0, GWP-3).

■ **Stainless steel cabinet construction**

The PRO series model boasts a stainless steel interior and a 22 gauge stainless steel exterior (galvanized steel bottom). It guarantees the utmost in cleanliness and long product life. The PRO series adds a touch of style to the most refined setting.

■ **Sturdy, clean stainless steel shelving**

Shelves are the most important part of cleanliness as they come in direct contact with food. The PRO series uniquely provides stainless steel shelving (only PST-48-18-D2R(L)-FB-N, PST-60-24-D2R(L)-FB-N).

■ **9-1/2" deep, 1/2" thick high-density Polyethylene cutting board included with convenient side rail**

■ **Spring assisted heavy duty gravity hinge (only PST-48-18-D2R(L)-FB-N, PST-60-24-D2R(L)-FB-N)**

■ **Easy removal hood & hood lid for cleaning**

■ **Insulated hood & hood lid**

■ **Refrigerator holds 33°F ~ 39°F for the best in food preservation**



PST-60-24-D2R-FB-N

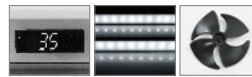

LED interior lighting & fan control

Energy efficient LED lighting lights every corner, making items easy to find. Fan control function automatically shuts off the fan when the door is open, which prevents hot air from being drawn in, thus maintaining the cool inner temperature (only PST-48-18-D2R(L)-FB-N, PST-60-24-D2R(L)-FB-N).

■ **Standard features**

- Anti-corrosion coated evaporator
- Self-contained system
- High-density polyurethane insulation
- 4" dia. swivel casters with locks on the front set
- 1/6 size, 4" deep condiment pans included (top of cabinet)
- Drawers accommodate 6" deep pans (pans not included)
- Door locks (only PST-48-18-D2R(L)-FB-N, PST-60-24-D2R(L)-FB-N)
- Lead time applies

■ **Optional features**

- Stainless steel single/double overshef available (except PST-28-12-D2-FB-N)
- Removable food covers available
- Legs available for all models: 6"
- Casters available for all models: 1" (1.5" low profile caster kit for PST-28-12-D2-FB-N), 2.5" (except PST-28-12-D2-FB-N), 5"

PST MODELS SPECIFICATIONS

ELECTRICAL DATA	PST-28-12-D2-FB-N	PST-48-18-D2R(L)-FB-N	PST-48-18-D4-FB-N	PST-60-24-D2R(L)-FB-N
Voltage	115/60/1	115/60/1	115/60/1	115/60/1
Plug Type	Ⓢ NEMA 5-15P	Ⓢ NEMA 5-15P	Ⓢ NEMA 5-15P	Ⓢ NEMA 5-15P
Full Load Amp.	6.6	6.5	6.5	8.9
Compressor HP	1/6	1/5	1/5	1/5
Cord Length (ft.)	10	10	10	10
Refrigerant	R-290	R-290	R-290	R-290
DIMENSIONAL DATA				
Net Capacity (cu. ft.)	6.5	11.1	11.1	14.8
Ext. Dimension (L x D x H†) (in.)	27 1/2 x 34 x 39 5/8	48 1/4 x 34 x 39 5/8	48 1/4 x 34 x 39 5/8	60 1/4 x 34 x 39 5/8
# of Doors	-	1	-	1
# of Drawers	2	2	4	2
# of Shelves (Size (L x D) (in.))	-	1 (21 x 17)	-	1 (27 x 17)
# of Pans	12	18	18	24
Net Weight (lbs.)	225	270	286	342
Gross Weight (lbs.)	231	282	298	357

Design and specifications subject to change without notice. Most updated spec sheets are available at www.turboairinc.com.

Actual shipping weight may differ due to extra packing materials for product protection.

* Depth does not include 3" for cutting boards. † Height does not include 4-1/2" for caster height.

■ **WARRANTY: 5 Year Parts and Labor Warranty, 7 Year Compressor Warranty**

MEGA TOP UNITS - FRONT BREATHING AIRFLOW/DRAWERS NATURAL Refrigerant

Self-Cleaning Condenser Equipped Units

■ **Self-Cleaning Condenser (Patented)**

The accumulation of dust in the condenser can cause the failure or breakdown of refrigerators. Refrigerators run normally until they reach a certain level of accumulation. At some point, when they are over the limit, their performance drops quickly resulting in damage to, or disposal of the stored products inside. The Self-Cleaning Condenser device keeps the condenser clean and prevents system failure by automatically brushing daily.

■ **Digital temperature control & monitor system**

Keeps food products safe by maintaining constant temperatures. External digital display allows for easy monitoring.

■ **Front Breathing airflow**

Front Breathing airflow is designed to draw in air and discharge from the front, allowing units to run at high efficiency in tight spaces and eliminates the need for surrounding clearances.

■ **Hydrocarbon refrigerants (R-290)**

With innovative and eco-friendly technology, Turbo Air brings you hydrocarbon refrigerators designed to meet DOE's Energy Conservation Standards in 2017 and to use EPA's SNAP Program approved HC refrigerants. Hydrocarbon refrigerants do not deplete the ozone layer and have very low contribution to global warming (ODP-0, GWP-3).

■ **Stainless steel cabinet construction**

The PRO series model boasts a stainless steel interior and a 22 gauge stainless steel exterior (galvanized steel bottom). It guarantees the utmost in cleanliness and long product life. The PRO series adds a touch of style to the most refined setting.

■ **Sturdy, clean stainless steel shelving**

Shelves are the most important part of cleanliness as they come in direct contact with food. The PRO series uniquely provides stainless steel shelving (only PST-72-30-D2R(L)-FB-N).

■ **9-1/2" deep, 1/2" thick high-density Polyethylene cutting board included with convenient side rail**

■ **Spring assisted heavy duty gravity hinge (only PST-72-30-D2R(L)-FB-N)**

■ **Easy removal hood & hood lid for cleaning**

■ **Insulated hood & hood lid**

■ **Refrigerator holds 33°F ~ 39°F for the best in food preservation**



PST-72-30-D2R-FB-N

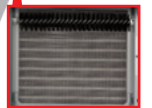

Self-Cleaning Condenser
Maintenance-free during warranty period

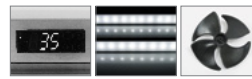

LED interior lighting & fan control

Energy efficient LED lighting lights every corner, making items easy to find. Fan control function automatically shuts off the fan when the door is open, which prevents hot air from being drawn in, thus maintaining the cool inner temperature (only PST-72-30-D2R(L)-FB-N).

■ **Standard features**

- Anti-corrosion coated evaporator
- Self-contained system
- 4" dia. swivel casters with locks on the front set
- 1/6 size, 4" deep condiment pans included (top of cabinet)
- Drawers accommodate 6" deep pans (pans not included)
- Door locks (only PST-72-30-D2R(L)-FB-N)
- High-density polyurethane insulation
- Lead time applies

■ **Optional features**

- Stainless steel single/double overshelf available
- Removable food covers available
- Legs available for all models: 6"
- Casters available for all models: 1", 2.5", 5"

PST MODELS SPECIFICATIONS

ELECTRICAL DATA	PST-60-24-D4-FB-N	PST-72-30-D2R(L)-FB-N	PST-72-30-D4-FB-N
Voltage	115/60/1	115/60/1	115/60/1
Plug Type	Ⓜ NEMA 5-15P	Ⓜ NEMA 5-15P	Ⓜ NEMA 5-15P
Full Load Amp.	8.9	9.9	9.9
Compressor HP	1/5	3/8	3/8
Cord Length (ft.)	10	10	10
Refrigerant	R-290	R-290	R-290
DIMENSIONAL DATA			
Net Capacity (cu. ft.)	14.8	17.6	17.6
Ext. Dimension (L x D [*] x H [†]) (in.)	60 ^{1/4} x 34 x 39 ^{5/8}	72 ^{5/8} x 34 x 39 ^{5/8}	72 ^{5/8} x 34 x 39 ^{5/8}
# of Doors	-	1	-
# of Drawers	4	2	4
# of Shelves (Size (L x D) (in.))	-	1 (33 ^{1/8} x 17)	-
# of Pans	24	30	30
Net Weight (lbs.)	374	384	395
Gross Weight (lbs.)	394	410	414

Design and specifications subject to change without notice. Most updated spec sheets are available at www.turboairinc.com.

Actual shipping weight may differ due to extra packing materials for product protection.

* Depth does not include 3" for cutting boards. † Height does not include 4-1/2" for caster height.

■ **WARRANTY: 5 Year Parts and Labor Warranty, 7 Year Compressor Warranty**

PIZZA PREP TABLES NATURAL Refrigerant

Self-Cleaning Condenser Equipped Units

Self-Cleaning Condenser (Patented)

The accumulation of dust in the condenser can cause the failure or breakdown of refrigerators. Refrigerators run normally until they reach a certain level of accumulation. At some point, when they are over the limit, their performance drops quickly resulting in damage to, or disposal of the stored products inside. The Self-Cleaning Condenser device keeps the condenser clean and prevents system failure by automatically brushing daily.

Hydrocarbon refrigerants (R-290)

With innovative and eco-friendly technology, Turbo Air brings you hydrocarbon refrigerators designed to meet DOE's Energy Conservation Standards in 2017 and to use EPA's SNAP Program approved HC refrigerants. Hydrocarbon refrigerants do not deplete the ozone layer and have very low contribution to global warming (ODP-0, GWP-3).

Cold Bunker system

Our innovative forced air system allows cold air to flow all around the food pan area, covering not only underneath the pan, but also the front, top and the rear. This unique air flow creates a cold air-shield around the pan, which maintains the food temperature at under 41°F (NSF requirement) even when the lids are opened. In addition, the compartment isolates pans from the reach-in area to prevent food spillage.

Stainless steel cabinet construction

The Turbo Air Super Deluxe model boasts a stainless steel interior (ABS door liner) and exterior (galvanized steel back & bottom). It guarantees the utmost in cleanliness and long product life. The Super Deluxe adds a touch of style to the most refined setting.

Sturdy, clean stainless steel shelving

Shelves are the most important part of cleanliness as they come in direct contact with food. After a while, PVC coated wire shelves may peel, rust and lead to unsanitary conditions. The Super Deluxe series uniquely provides stainless steel shelving.

Extra deep HDPE cutting board

Our cutting board is 19-1/4" deep and 1/2" thick to provide ample working space, and is made of easy to use and sanitize HDPE (High Density Polyethylene). The new side rail cutting board bracket makes it easy to secure and remove the cutting board.

Insulated pan cover

Side mount compressor unit

Compressors positioned on the side of the units make serving our units easy. Our front air intake feature also allows this model to be highly efficient in narrow spaces.



Self-Cleaning Condenser
Maintenance-free during warranty period



LED interior lighting & fan control

Energy efficient LED lighting lights every corner, making items easy to find. Fan control function automatically shuts off the fan when the door is open, which prevents hot air from being drawn in, thus maintaining the cool inner temperature.

Refrigerator holds 33°F ~ 41°F for the best in food preservation

Standard features

- Anti-corrosion coated evaporator
- Self-contained system
- 4" dia. swivel casters with locks on the front set
- 1/3 size, 6" deep condiment pans included
- 19-1/4" deep, 1/2" thick cutting board included
- Easily replaceable magnetic door gaskets
- High-density polyurethane insulation

Optional features

- Legs available for all models: 6"
- Half size pan rack for 18" x 26" sheet pans available
- Stainless steel single overshelf available (except TPR-93SD-N)
- Door locks available (extra lead time will apply)
- Casters available for all models: 2.5" (except TPR-93SD-N), 5"

TPR MODELS SPECIFICATIONS

ELECTRICAL DATA	TPR-44SD-N	TPR-67SD-N	TPR-93SD-N
Voltage	115/60/1	115/60/1	115/60/1
Plug Type	Ⓢ NEMA 5-15P	Ⓢ NEMA 5-15P	Ⓢ NEMA 5-15P
Full Load Amp.	3.2	4.2	5.6
Compressor HP	1/4	3/8	2/3
Cord Length (ft.)	9	9	9
Refrigerant	R-290	R-290	R-290
DIMENSIONAL DATA			
Net Capacity (cu. ft.)	14	20	31
Ext. Dimension (L x D* x H†) (in.)	44 x 32 1/4 x 37 1/8	67 x 32 1/4 x 37 1/8	93 x 32 1/4 x 37 1/8
# of Doors	1	2	3
# of Shelves (Size (L x D) (in.))	2 (25 x 25 1/2)	4 (24 x 25 1/2)	6 (24 x 25 1/2 (L/R), 25 7/8 x 25 1/2 (M))
# of Pans	6	9	12
Net Weight (lbs.)	222	355	536
Gross Weight (lbs.)	302	411	577

Design and specifications subject to change without notice. Most updated spec sheets are available at www.turboairinc.com.

Actual shipping weight may differ due to extra packing materials for product protection.

* Depth does not include 3" for cutting boards and 1" for rear spacers. † Height does not include 5" for caster height.

WARRANTY: 5 Year Parts and Labor Warranty, 7 Year Compressor Warranty

PIZZA PREP TABLES - DRAWERS NATURAL Refrigerant

Self-Cleaning Condenser Equipped Units

■ **Self-Cleaning Condenser (Patented)**

The accumulation of dust in the condenser can cause the failure or breakdown of refrigerators. Refrigerators run normally until they reach a certain level of accumulation. At some point, when they are over the limit, their performance drops quickly resulting in damage to, or disposal of the stored products inside. The Self-Cleaning Condenser device keeps the condenser clean and prevents system failure by automatically brushing daily.

■ **Hydrocarbon refrigerants (R-290)**

With innovative and eco-friendly technology, Turbo Air brings you hydrocarbon refrigerators designed to meet DOE's Energy Conservation Standards in 2017 and to use EPA's SNAP Program approved HC refrigerants. Hydrocarbon refrigerants do not deplete the ozone layer and have very low contribution to global warming (ODP-0, GWP-3).

■ **Cold Bunker system**

Our innovative forced air system allows cold air to flow all around the food pan area, covering not only underneath the pan, but also the front, top and the rear. This unique air flow creates a cold air-shield around the pan, which maintains the food temperature at under 41°F (NSF requirement) even when the lids are opened. In addition, the compartment isolates pans from the reach-in area to prevent food spillage.

■ **Stainless steel cabinet construction**

The Turbo Air Super Deluxe model boasts a stainless steel interior (ABS door liner) and exterior (galvanized steel back & bottom) including durable stainless steel drawers. It guarantees the utmost in cleanliness and long product life. The Super Deluxe adds a touch of style to the most refined setting.

■ **Sturdy, clean stainless steel shelving & drawers**

Shelves are the most important part of cleanliness as they come in direct contact with food. After a while, PVC coated wire shelves may peel, rust and lead to unsanitary conditions. The Super Deluxe series uniquely provides stainless steel shelving.

■ **Extra deep HDPE cutting board**

Our cutting board is 19-1/4" deep and 1/2" thick to provide ample working space, and is made of easy to use and sanitize HDPE (High Density Polyethylene). The new side rail cutting board bracket makes it easy to secure and remove the cutting board.

■ **Insulated pan cover**

■ **Side mount compressor unit**

Compressors positioned on the side of the units make serving our units easy. Our front air intake feature also allows this model to be highly efficient in narrow spaces.

■ **Refrigerator holds 33°F ~ 41°F for the best in food preservation**



TPR-93SD-D6-N
Each drawer accommodates up to 6" deep sixth (1/6) size pans (drawer pans not included)

TPR-67SD-D2-N

Self-Cleaning Condenser
Maintenance-free during warranty period

TPR-44SD-D2-N

■ **Standard features**

- Anti-corrosion coated evaporator
- Self-contained system
- 4" dia. swivel casters with locks on the front set
- 1/3 size, 6" deep condiment pans included (top of cabinet)
- 19-1/4" deep, 1/2" thick cutting board included
- Easily replaceable magnetic door gaskets

■ **Optional features**

- Stainless steel single overs shelf available (except TPR-93SD-D2/D4/D6-N)
- Legs available for all models: 6"
- Casters available for all models: 2.5" (except TPR-93SD-D2/D4/D6-N), 5"

TPR MODELS SPECIFICATIONS

ELECTRICAL DATA	TPR-44SD-D2-N	TPR-67SD-D2-N	TPR-67SD-D4-N	TPR-93SD-D2-N	TPR-93SD-D4-N	TPR-93SD-D6-N
Voltage	115/60/1	115/60/1	115/60/1	115/60/1	115/60/1	115/60/1
Plug Type	Ⓜ NEMA 5-15P	Ⓜ NEMA 5-15P	Ⓜ NEMA 5-15P	Ⓜ NEMA 5-15P	Ⓜ NEMA 5-15P	Ⓜ NEMA 5-15P
Full Load Amp.	3.2	4.2	4.2	5.6	5.6	5.6
Compressor HP	1/4	3/8	3/8	2/3	2/3	2/3
Cord Length (ft.)	9	9	9	9	9	9
Refrigerant	R-290	R-290	R-290	R-290	R-290	R-290
DIMENSIONAL DATA						
Net Capacity (cu. ft.)	14	20	20	31	31	31
Ext. Dimension (L x D x H†) (in.)	44 x 32 1/4 x 37 1/8	67 x 32 1/4 x 37 1/8	67 x 32 1/4 x 37 1/8	93 x 32 1/4 x 37 1/8	93 x 32 1/4 x 37 1/8	93 x 32 1/4 x 37 1/8
# of Doors	-	1	-	2	1	-
# of Drawers	2	2	4	2	4	6
# of Shelves (Size (L x D) (in.))	-	2 (24 x 25 1/2)	-	4 (24 x 25 1/2 (L/R), 25 7/8 x 25 1/2 (M))	2 (24 x 25 1/2)	-
# of Pans	6	9	9	12	12	12
Net Weight (lbs.)	266	407	418	601	612	623
Gross Weight (lbs.)	321	561	572	711	722	733

Design and specifications subject to change without notice. Most updated spec sheets are available at www.turboairinc.com.

Actual shipping weight may differ due to extra packing materials for product protection.

* Depth does not include 3" for cutting boards and 1" for rear spacers. † Height does not include 4-3/4" for caster height.

■ **WARRANTY: 5 Year Parts and Labor Warranty, 7 Year Compressor Warranty**

SANDWICH/SALAD UNITS NATURAL Refrigerant

Self-Cleaning Condenser Equipped Units

■ **Self-Cleaning Condenser (Patented)**

The accumulation of dust in the condenser can cause the failure or breakdown of refrigerators. Refrigerators run normally until they reach a certain level of accumulation. At some point, when they are over the limit, their performance drops quickly resulting in damage to, or disposal of the stored products inside. The Self-Cleaning Condenser device keeps the condenser clean and prevents system failure by automatically brushing daily.

■ **Digital temperature control & monitor system**

Keeps food products safe by maintaining constant temperatures. External digital display allows for easy monitoring.

■ **Hydrocarbon refrigerants (R-290 / R-600a)**

With innovative and eco-friendly technology, Turbo Air brings you hydrocarbon refrigerators designed to meet DOE's Energy Conservation Standards in 2017 and to use EPA's SNAP Program approved HC refrigerants. Hydrocarbon refrigerants do not deplete the ozone layer and have very low contribution to global warming (ODP-0, GWP-3).

■ **Cold Bunker system**

Our innovative forced air system allows cold air to flow all around the food pan area, covering not only underneath the pan, but also the front, top and the rear. This unique air flow creates a cold air-shield around the pan, which maintains the food temperature at under 41°F (NSF requirement) even when the lids are opened. In addition, the compartment isolates pans from the reach-in area to prevent food spillage.

■ **Stainless steel cabinet construction**

The Turbo Air Super Deluxe model boasts a stainless steel interior (ABS door liner) and exterior (galvanized steel back & bottom). It guarantees the utmost in cleanliness and long product life. The Super Deluxe adds a touch of style to the most refined setting.

■ **Sturdy, clean stainless steel shelving**

Shelves are the most important part of cleanliness as they come in direct contact with food. After a while, PVC coated wire shelves may peel, rust and lead to unsanitary conditions. The Super Deluxe series uniquely provides stainless steel shelving.

■ **High-density polyurethane insulation**

The entire cabinet structure and solid doors are foamed-in-place high density, CFC free polyurethane insulation.

■ **9-1/2" deep, 1/2" thick high-density Polyethylene cutting board included with convenient side rail**

■ **Insulated pan cover**

■ **Refrigerator holds 33°F ~ 39°F for the best in food preservation**



Self-Cleaning Condenser
Maintenance-free
during warranty period

TST-36SD-N6

TST-60SD-N



LED interior lighting & fan control

Energy efficient LED lighting lights every corner, making items easy to find. Fan control function automatically shuts off the fan when the door is open, which prevents hot air from being drawn in, thus maintaining the cool inner temperature.

■ **Standard features**

- Anti-corrosion coated evaporator
- Self-contained system
- 4" dia. swivel casters with locks on the front set
- 1/6 size, 4" deep condiment pans included

■ **Optional features**

- Stainless steel single/double overshelf available (except TST-28SD-N)
- Removable food covers available
- Legs available for all models: 6"
- Door locks available (extra lead time will apply)
- Casters available for all models: 1", 2.5", 5"

TST MODELS SPECIFICATIONS

ELECTRICAL DATA	TST-28SD-N	TST-36SD-N6	TST-48SD-N	TST-60SD-N	TST-72SD-N
Voltage	115/60/1	115/60/1	115/60/1	115/60/1	115/60/1
Plug Type	Ⓢ NEMA 5-15P	Ⓢ NEMA 5-15P	Ⓢ NEMA 5-15P	Ⓢ NEMA 5-15P	Ⓢ NEMA 5-15P
Full Load Amp.	3.8	3.9	4.4	4.4	5.7
Compressor HP	1/6	1/5	1/5	1/5	2/5
Cord Length (ft.)	9	9	9	9	9
Refrigerant	R-290	R-600a	R-290	R-290	R-290
DIMENSIONAL DATA					
Net Capacity (cu. ft.)	7	9.5	12	17	19
Ext. Dimension (L x D [*] x H [†]) (in.)	27 1/2 x 30 x 37 1/2	36 3/8 x 30 x 37 1/2	48 1/4 x 30 x 37 1/2	60 1/4 x 30 x 37 1/2	72 5/8 x 30 x 37 1/2
# of Doors	1	2	2	2	3
# of Shelves (Size (L x D) (in.))	1 (22 1/2 x 17)	2 (15 x 17)	2 (21 x 17)	2 (27 x 17)	3 (21 x 17 (L/R), 23 x 17 (M))
# of Pans	8	10	12	16	18
Net Weight (lbs.)	170	187	243	284	344
Gross Weight (lbs.)	195	230	273	316	372

Design and specifications subject to change without notice. Most updated spec sheets are available at www.turboairinc.com.

Actual shipping weight may differ due to extra packing materials for product protection.

* Depth does not include 1" for rear spacers. † Height does not include 4-3/4" for caster height.

■ **WARRANTY: 5 Year Parts and Labor Warranty, 7 Year Compressor Warranty**

SANDWICH/SALAD UNITS - CLEAR LID NATURAL Refrigerant

Self-Cleaning Condenser Equipped Units

■ **Self-Cleaning Condenser (Patented)**

The accumulation of dust in the condenser can cause the failure or breakdown of refrigerators. Refrigerators run normally until they reach a certain level of accumulation. At some point, when they are over the limit, their performance drops quickly resulting in damage to, or disposal of the stored products inside. The Self-Cleaning Condenser device keeps the condenser clean and prevents system failure by automatically brushing the condenser daily.

■ **Digital temperature control & monitor system**

Keeps food products safe by maintaining constant temperatures. External digital display allows for easy monitoring.

■ **Hydrocarbon refrigerants (R-290)**

With innovative and eco-friendly technology, Turbo Air brings you hydrocarbon refrigerators designed to meet DOE's Energy Conservation Standards in 2017 and to use EPA's SNAP Program approved HC refrigerants. Hydrocarbon refrigerants do not deplete the ozone layer and have very low contribution to global warming (ODP-0, GWP-3).

■ **Cold Bunker system**

Our innovative forced air system allows cold air to flow all around the food pan area, covering not only underneath the pan, but also the front, top and the rear. This unique air flow creates a cold air-shield around the pan, which maintains the food temperature at under 41°F (NSF requirement) even when the lids are opened. In addition, the compartment isolates pans from the reach-in area to prevent food spillage.

■ **Stainless steel cabinet construction**

The Turbo Air Super Deluxe model boasts a stainless steel interior (ABS door liner) and exterior (galvanized steel back & bottom). It guarantees the utmost in cleanliness and long product life. The Super Deluxe adds a touch of style to the most refined setting.

■ **Sturdy, clean stainless steel shelving**

Shelves are the most important part of cleanliness as they come in direct contact with food. After a while, PVC coated wire shelves may peel, rust and lead to unsanitary conditions. The Super Deluxe series uniquely provides stainless steel shelving.

■ **High-density polyurethane insulation**

The entire cabinet structure and solid doors are foamed-in-place high density, CFC free polyurethane insulation.

■ **9-1/2" deep, 1/2" thick high-density Polyethylene cutting board included with convenient side rail**

■ **Insulated hood & clear lid**

■ **Refrigerator holds 33°F ~ 39°F for the best in food preservation**



TST-48SD-N-CL



Self-Cleaning Condenser
Maintenance-free during warranty period

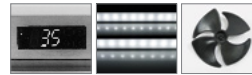

LED interior lighting & fan control

Energy efficient LED lighting lights every corner, making items easy to find. Fan control function automatically shuts off the fan when the door is open, which prevents hot air from being drawn in, thus maintaining the cool inner temperature.

■ **Standard features**

- Anti-corrosion coated evaporator
- Self-contained system
- 4" dia. swivel casters with locks on the front set
- 1/6 size, 4" deep condiment pans included
- Lead time applies

■ **Optional features**

- Stainless steel single/double overshelf available
- Legs available for all models: 6"
- Door locks available (extra lead time will apply)
- Casters available for all models: 1", 2.5", 5"

TST MODELS SPECIFICATIONS

ELECTRICAL DATA	TST-48SD-N-CL	TST-60SD-N-CL	TST-72SD-N-CL
Voltage	115/60/1	115/60/1	115/60/1
Plug Type	Ⓜ NEMA 5-15P	Ⓜ NEMA 5-15P	Ⓜ NEMA 5-15P
Full Load Amp.	6.5	8.9	9.9
Compressor HP	1/5	1/5	3/8
Cord Length (ft.)	10	10	10
Refrigerant	R-290	R-290	R-290
DIMENSIONAL DATA			
Net Capacity (cu. ft.)	12	16	19
Ext. Dimension (L x D* x H†) (in.)	48 1/4 x 30 x 37 5/8	60 1/4 x 30 x 37 5/8	72 5/8 x 30 x 37 5/8
# of Doors	2	2	3
# of Shelves (Size (L x D) (in.))	2 (21 x 17)	2 (27 x 17)	3 (21 x 17 (L/R), 23 x 17 (M))
# of Pans	12	16	18
Net Weight (lbs.)	240	281	342
Gross Weight (lbs.)	271	313	370

Design and specifications subject to change without notice. Most updated spec sheets are available at www.turboairinc.com.

Actual shipping weight may differ due to extra packing materials for product protection.

* Depth does not include 1" for rear spacers. † Height does not include 4-1/2" for caster height.

■ **WARRANTY: 5 Year Parts and Labor Warranty, 7 Year Compressor Warranty**

SANDWICH/SALAD UNITS - GLASS LID NATURAL Refrigerant

Self-Cleaning Condenser Equipped Units

Self-Cleaning Condenser (Patented)

The accumulation of dust in the condenser can cause the failure or breakdown of refrigerators. Refrigerators run normally until they reach a certain level of accumulation. At some point, when they are over the limit, their performance drops quickly resulting in damage to, or disposal of the stored products inside. The Self-Cleaning Condenser device keeps the condenser clean and prevents system failure by automatically brushing daily.

Digital temperature control & monitor system

Keeps food products safe by maintaining constant temperatures. External digital display allows for easy monitoring.

Hydrocarbon refrigerants (R-290)

With innovative and eco-friendly technology, Turbo Air brings you hydrocarbon refrigerators designed to meet DOE's Energy Conservation Standards in 2017 and to use EPA's SNAP Program approved HC refrigerants. Hydrocarbon refrigerants do not deplete the ozone layer and have very low contribution to global warming (ODP-0, GWP-3).

Cold Bunker system

Our innovative forced air system allows cold air to flow all around the food pan area, covering not only underneath the pan, but also the front, top and the rear. This unique air flow creates a cold air-shield around the pan, which maintains the food temperature at under 41°F (NSF requirement) even when the lids are opened. In addition, the compartment isolates pans from the reach-in area to prevent food spillage.

Stainless steel cabinet construction

The Turbo Air Super Deluxe model boasts a stainless steel interior (ABS door liner) and exterior (galvanized steel back & bottom). It guarantees the utmost in cleanliness and long product life. The Super Deluxe adds a touch of style to the most refined setting.

Sturdy, clean stainless steel shelving

Shelves are the most important part of cleanliness as they come in direct contact with food. After a while, PVC coated wire shelves may peel, rust and lead to unsanitary conditions. The Super Deluxe series uniquely provides stainless steel shelving.

High-density polyurethane insulation

The entire cabinet structure and solid doors are foamed-in-place high density, CFC free polyurethane insulation.

6-1/4" deep, 1/2" thick high-density Polyethylene cutting board included with convenient side rail

Refrigerator holds 33°F ~ 39°F for the best in food preservation



TST-48SD-N-GL

Self-Cleaning Condenser
Maintenance-free during warranty period

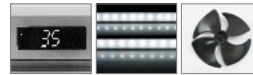

LED interior lighting & fan control

Energy efficient LED lighting lights every corner, making items easy to find. Fan control function automatically shuts off the fan when the door is open, which prevents hot air from being drawn in, thus maintaining the cool inner temperature.

Standard features

- Anti-corrosion coated evaporator
- Self-contained system
- 4" dia. swivel casters with locks on the front set
- 1/6 size, 4" deep condiment pans included

Optional features

- Additional stainless steel shelf
- Legs available for all models: 6"
- Door locks available (extra lead time will apply)
- Casters available for all models: 1", 2.5", 5"

TST MODELS SPECIFICATIONS

ELECTRICAL DATA	TST-28SD-N-GL	TST-48SD-N-GL	TST-60SD-N-GL	TST-72SD-N-GL
Voltage	115/60/1	115/60/1	115/60/1	115/60/1
Plug Type	Ⓜ NEMA 5-15P	Ⓜ NEMA 5-15P	Ⓜ NEMA 5-15P	Ⓜ NEMA 5-15P
Full Load Amp.	6.6	6.5	8.9	9.9
Compressor HP	1/6	1/6	1/5	3/8
Cord Length (ft.)	10	10	10	10
Refrigerant	R-290	R-290	R-290	R-290
DIMENSIONAL DATA				
Net Capacity (cu. ft.)	7	12	16	19
Ext. Dimension (L x D x H†) (in.)	28 x 32 ⁷ / ₈ x 31 ³ / ₄	48 ¹ / ₄ x 32 ⁷ / ₈ x 31 ³ / ₄	60 ¹ / ₄ x 32 ⁷ / ₈ x 31 ³ / ₄	72 ⁵ / ₈ x 32 ⁷ / ₈ x 31 ³ / ₄
# of Doors	1	2	2	3
# of Shelves (Size (L x D) (in.))	1 (22 ¹ / ₂ x 17)	2 (21 x 17)	2 (27 x 17)	3 (21 x 17 (L/R), 23 x 17 (M))
# of Pans	8	12	16	18
Net Weight (lbs.)	179	255	298	361
Gross Weight (lbs.)	195	272	316	372

Design and specifications subject to change without notice. Most updated spec sheets are available at www.turboairinc.com.

Actual shipping weight may differ due to extra packing materials for product protection.

† Height does not include 4-1/2" for caster height.

WARRANTY: 5 Year Parts and Labor Warranty, 7 Year Compressor Warranty

SANDWICH/SALAD UNITS - DRAWERS/GLASS LID NATURAL Refrigerant

Self-Cleaning Condenser Equipped Units

■ **Self-Cleaning Condenser (Patented)**

The accumulation of dust in the condenser can cause the failure or breakdown of refrigerators. Refrigerators run normally until they reach a certain level of accumulation. At some point, when they are over the limit, their performance drops quickly resulting in damage to, or disposal of the stored products inside. The Self-Cleaning Condenser device keeps the condenser clean and prevents system failure by automatically brushing daily.

■ **Digital temperature control & monitor system**

Keeps food products safe by maintaining constant temperatures. External digital display allows for easy monitoring.

■ **Hydrocarbon refrigerants (R-290)**

With innovative and eco-friendly technology, Turbo Air brings you hydrocarbon refrigerators designed to meet DOE's Energy Conservation Standards in 2017 and to use EPA's SNAP Program approved HC refrigerants. Hydrocarbon refrigerants do not deplete the ozone layer and have very low contribution to global warming (ODP-0, GWP-3).

■ **Cold Bunker system**

Our innovative forced air system allows cold air to flow all around the food pan area, covering not only underneath the pan, but also the front, top and the rear. This unique air flow creates a cold air-shield around the pan, which maintains the food temperature at under 41°F (NSF requirement) even when the lids are opened. In addition, the compartment isolates pans from the reach-in area to prevent food spillage.

■ **Stainless steel cabinet construction**

The Turbo Air Super Deluxe model boasts a stainless steel interior (ABS door liner) and exterior (galvanized steel back & bottom). It guarantees the utmost in cleanliness and long product life. The Super Deluxe adds a touch of style to the most refined setting.

■ **Sturdy, clean stainless steel shelving**

Shelves are the most important part of cleanliness as they come in direct contact with food. After a while, PVC coated wire shelves may peel, rust and lead to unsanitary conditions. The Super Deluxe series uniquely provides stainless steel shelving.

■ **High-density polyurethane insulation**

The entire cabinet structure and solid doors are foamed-in-place high density, CFC free polyurethane insulation.

■ **6-1/4" deep, 1/2" thick high-density Polyethylene cutting board included with convenient side rail**

■ **Refrigerator holds 33°F ~ 39°F for the best in food preservation**



TST-72SD-D6-N-GL

Self-Cleaning Condenser
Maintenance-free during warranty period

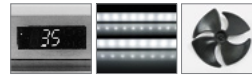

LED interior lighting & fan control

Energy efficient LED lighting lights every corner, making items easy to find. Fan control function automatically shuts off the fan when the door is open, which prevents hot air from being drawn in, thus maintaining the cool inner temperature.

■ **Standard features**

- Anti-corrosion coated evaporator
- Self-contained system
- 4" dia. swivel casters with locks on the front set
- 1/6 size, 4" deep condiment pans included

■ **Optional features**

- Additional stainless steel shelf
- Legs available for all models: 6"
- Door locks available (extra lead time will apply)
- Casters available for all models: 1", 2.5", 5"

TST MODELS SPECIFICATIONS

ELECTRICAL DATA		TST-72SD-D6-N-GL
Voltage		115/60/1
Plug Type		Ⓜ NEMA 5-15P
Full Load Amp.		9.9
Compressor HP		3/8
Cord Length (ft.)		10
Refrigerant		R-290
DIMENSIONAL DATA		
Net Capacity (cu. ft.)		19
Ext. Dimension (L x D x H†) (in.)		72 ⁵ / ₈ x 30 ⁵ / ₈ x 34 ⁷ / ₈
# of Doors		-
# of Shelves		-
# of Pans		18
Net Weight (lbs.)		356
Gross Weight (lbs.)		396

Design and specifications subject to change without notice. Most updated spec sheets are available at www.turboairinc.com.

Actual shipping weight may differ due to extra packing materials for product protection.

† Height does not include 4-1/2" for caster height.

■ **WARRANTY: 5 Year Parts and Labor Warranty, 7 Year Compressor Warranty**

SANDWICH/SALAD UNITS - DRAWERS NATURAL Refrigerant

Self-Cleaning Condenser Equipped Units

■ **Self-Cleaning Condenser (Patented)**

The accumulation of dust in the condenser can cause the failure or breakdown of refrigerators. Refrigerators run normally until they reach a certain level of accumulation. At some point, when they are over the limit, their performance drops quickly resulting in damage to, or disposal of the stored products inside. The Self-Cleaning Condenser device keeps the condenser clean and prevents system failure by automatically brushing daily.

■ **Digital temperature control & monitor system**

Keeps food products safe by maintaining constant temperatures. External digital display allows for easy monitoring.

■ **Hydrocarbon refrigerants (R-290)**

With innovative and eco-friendly technology, Turbo Air brings you hydrocarbon refrigerators designed to meet DOE's Energy Conservation Standards in 2017 and to use EPA's SNAP Program approved HC refrigerants. Hydrocarbon refrigerants do not deplete the ozone layer and have very low contribution to global warming (ODP-0, GWP-3).

■ **Cold Bunker system**

Our innovative forced air system allows cold air to flow all around the food pan area, covering not only underneath the pan, but also the front, top and the rear. This unique air flow creates a cold air-shield around the pan, which maintains the food temperature at under 41°F (NSF requirement) even when the lids are opened.

■ **Stainless steel cabinet construction**

The Turbo Air Super Deluxe model boasts a stainless steel interior (ABS door liner) and exterior (galvanized steel back & bottom) including durable stainless steel drawers. It guarantees the utmost in cleanliness and long product life. The Super Deluxe adds a touch of style to the most refined setting.

■ **Sturdy, clean stainless steel shelving**

Shelves are the most important part of cleanliness as they come in direct contact with food. After a while, PVC coated wire shelves may peel, rust and lead to unsanitary conditions. The Super Deluxe series uniquely provides stainless steel shelving.

■ **9-1/2" deep, 1/2" thick high-density Polyethylene cutting board included with convenient side rail**

■ **Insulated pan cover**

■ **Refrigerator holds 33°F ~ 39°F for the best in food preservation**



TST-72SD-D4R-N

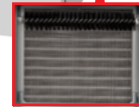

Self-Cleaning Condenser
Maintenance-free during warranty period

■ **Each top drawer accommodates up to 6" deep, (4) four 1/6 size pans. And each bottom drawer accommodates up to 6" deep (4) four 1/6 size pans (drawer pans not included)**

■ **Standard features**

- Anti-corrosion coated evaporator
- Self-contained system
- 4" dia. swivel casters with locks on the front set
- 1/6 size, 4" deep condiment pans included (top of cabinet)

■ **Optional features**

- Stainless steel single/double overshelf available
- Clear lids available
- Removable food covers available
- Legs available for all models: 6"
- Casters available for all models: 1", 2.5", 5"

TST MODELS SPECIFICATIONS

ELECTRICAL DATA	TST-72SD-D4R-N
Voltage	115/60/1
Plug Type	Ⓜ NEMA 5-15P
Full Load Amp.	9.9
Compressor HP	3/8
Cord Length (ft.)	10
Refrigerant	R-290
DIMENSIONAL DATA	
Net Capacity (cu. ft.)	23
Ext. Dimension (L x D [†] x H [†]) (in.)	72 ^{5/8} x 30 x 37 ^{5/8}
# of Doors	1
# of Drawers	4
# of Shelves (Size (L x D) (in.))	1 (21 x 17)
# of Pans	18
Net Weight (lbs.)	344
Gross Weight (lbs.)	372

Design and specifications subject to change without notice. Most updated spec sheets are available at www.turboairinc.com.

Actual shipping weight may differ due to extra packing materials for product protection.

* Depth does not include 1" for rear spacers. † Height does not include 4-1/2" for caster height.

■ **WARRANTY: 5 Year Parts and Labor Warranty, 7 Year Compressor Warranty**

SANDWICH/SALAD UNITS - DRAWERS/SLIDE BACK LID



Self-Cleaning Condenser Equipped Units

■ **Self-Cleaning Condenser (Patented)**

The accumulation of dust in the condenser can cause the failure or breakdown of refrigerators. Refrigerators run normally until they reach a certain level of accumulation. At some point, when they are over the limit, their performance drops quickly resulting in damage to, or disposal of the stored products inside. The Self-Cleaning Condenser device keeps the condenser clean and prevents system failure by automatically brushing daily.

■ **Digital temperature control & monitor system**

Keeps food products safe by maintaining constant temperatures. External digital display allows for easy monitoring.

■ **Hydrocarbon refrigerants (R-290)**

With innovative and eco-friendly technology, Turbo Air brings you hydrocarbon refrigerators designed to meet DOE's Energy Conservation Standards in 2017 and to use EPA's SNAP Program approved HC refrigerants. Hydrocarbon refrigerants do not deplete the ozone layer and have very low contribution to global warming (ODP-0, GWP-3).

■ **Cold Bunker system**

Our innovative forced air system allows cold air to flow all around the food pan area, covering not only underneath the pan, but also the front, top and the rear. This unique air flow creates a cold air-shield around the pan, which maintains the food temperature at under 41°F (NSF requirement) even when the lids are opened.

■ **Stainless steel cabinet construction**

The Turbo Air Super Deluxe model boasts a stainless steel interior (ABS door liner) and exterior (galvanized steel back & bottom) including durable stainless steel drawers. It guarantees the utmost in cleanliness and long product life. The Super Deluxe adds a touch of style to the most refined setting.

■ **Sturdy, clean stainless steel shelving**

Shelves are the most important part of cleanliness as they come in direct contact with food. After a while, PVC coated wire shelves may peel, rust and lead to unsanitary conditions. The Super Deluxe series uniquely provides stainless steel shelving.

■ **9-1/2" deep, 1/2" thick high-density Polyethylene cutting board included with convenient side rail**

■ **Insulated pan cover**

■ **Refrigerator holds 33°F ~ 39°F for the best in food preservation**



TST-72SD-LRD2-N-SL

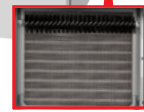

Self-Cleaning Condenser
Maintenance-free during warranty period

■ **Each top drawer accommodates up to 6" deep, (4) four 1/6 size pans. And each bottom drawer accommodates up to 6" deep (4) four 1/6 size pans (drawer pans not included)**

■ **Standard features**

- Anti-corrosion coated evaporator
- Self-contained system
- 4" dia. swivel casters with locks on the front set
- 1/6 size, 4" deep condiment pans included (top of cabinet)

■ **Optional features**

- Stainless steel single/double overshef available
- Clear lids available
- Removable food covers available
- Legs available for all models: 6"
- Casters available for all models: 1", 2.5", 5"

TST MODELS SPECIFICATIONS

ELECTRICAL DATA		TST-72SD-LRD2-N-SL
Voltage		115/60/1
Plug Type		Ⓜ NEMA 5-15P
Full Load Amp.		9.9
Compressor HP		3/8
Cord Length (ft.)		10
Refrigerant		R-290
DIMENSIONAL DATA		
Net Capacity (cu. ft.)		23
Ext. Dimension (L x D [†] x H [†]) (in.)		72 ^{5/8} x 30 x 37 ^{5/8}
# of Doors		2
# of Drawers		2
# of Shelves (Size (L x D) (in.))		2 (21 x 17)
# of Pans		18
Net Weight (lbs.)		356
Gross Weight (lbs.)		396

Design and specifications subject to change without notice. Most updated spec sheets are available at www.turboairinc.com.

Actual shipping weight may differ due to extra packing materials for product protection.

* Depth does not include 1" for rear spacers. † Height does not include 4-1/2" for caster height.

■ **WARRANTY: 5 Year Parts and Labor Warranty, 7 Year Compressor Warranty**

PREP TABLE + WORK STATIONS NATURAL Refrigerant

Self-Cleaning Condenser Equipped Units

■ **Self-Cleaning Condenser (Patented)**

The accumulation of dust in the condenser can cause the failure or breakdown of refrigerators. Refrigerators run normally until they reach a certain level of accumulation. At some point, when they are over the limit, their performance drops quickly resulting in damage to, or disposal of the stored products inside. The Self-Cleaning Condenser device keeps the condenser clean and prevents system failure by automatically brushing daily.

■ **Digital temperature control & monitor system**

Keeps food products safe by maintaining constant temperatures. External digital display allows for easy monitoring.

■ **Hydrocarbon refrigerants (R-290)**

With innovative and eco-friendly technology, Turbo Air brings you hydrocarbon refrigerators designed to meet DOE's Energy Conservation Standards in 2017 and to use EPA's SNAP Program approved HC refrigerants. Hydrocarbon refrigerants do not deplete the ozone layer and have very low contribution to global warming (ODP-0, GWP-3).

■ **Cold Bunker system**

Our innovative forced air system allows cold air to flow all around the food pan area, covering not only underneath the pan, but also the front, top and the rear. This unique air flow creates a cold air-shield around the pan, which maintains the food temperature at under 41°F (NSF requirement) even when the lids are opened.

■ **LED interior lighting & fan control**

Energy efficient LED lighting lights every corner, making items easy to find. Fan control function automatically shuts off the fan when the door is open, which prevents hot air from being drawn in, thus maintaining the cool inner temperature.

■ **High-density polyurethane insulation**

The entire cabinet structure and solid doors are foamed-in-place high density, CFC free polyurethane insulation.

■ **Stainless steel cabinet construction**

The Turbo Air Super Deluxe model boasts a stainless steel interior (ABS door liner) and exterior (galvanized steel back & bottom) including durable stainless steel drawers. It guarantees the utmost in cleanliness and long product life. The Super Deluxe adds a touch of style to the most refined setting.

■ **Sturdy, clean stainless steel shelving**

Shelves are the most important part of cleanliness as they come in direct contact with food. After a while, PVC coated wire shelves may peel, rust and lead to unsanitary conditions. The Super Deluxe series uniquely provides stainless steel shelving.



TST-60SD-08SM-N



Self-Cleaning Condenser
Maintenance-free during warranty period

■ **9-1/2" deep, 1/2" thick high-density Polyethylene cutting board included with convenient side rail**

■ **Insulated pan cover**

■ **Refrigerator holds 33°F ~ 39°F for the best in food preservation**

■ **Standard features**

- Anti-corrosion coated evaporator
- Self-contained system
- 4" dia. swivel casters with locks on the front set
- 1/6 size, 4" deep condiment pans included (top of cabinet)

■ **Optional features**

- Stainless steel single/double overself available
- Clear lids available
- Removable food covers available
- Legs available for all models: 6"
- Casters available for all models: 1", 2.5", 5"
- Door lock (lead time applies)

TST MODELS SPECIFICATIONS

ELECTRICAL DATA		TST-60SD-08SM-N
Voltage		115/60/1
Plug Type		Ⓢ NEMA 5-15P
Full Load Amp.		8.9
Compressor HP		1/5
Cord Length (ft.)		9
Refrigerant		R-290
DIMENSIONAL DATA		
Net Capacity (cu. ft.)		19
Ext. Dimension (L x D [†] x H [‡]) (in.)		60 1/4 x 30 x 37 5/8
# of Doors		2
# of Drawers		-
# of Shelves (Size (L x D) (in.))		2
# of Pans		8
Net Weight (lbs.)		280
Gross Weight (lbs.)		312

Design and specifications subject to change without notice. Most updated spec sheets are available at www.turboairinc.com.

Actual shipping weight may differ due to extra packing materials for product protection.

* Depth does not include 1" for rear spacers. † Height does not include 4-1/2" for caster height.

■ **WARRANTY: 5 Year Parts and Labor Warranty, 7 Year Compressor Warranty**

PREP TABLE + WORK STATIONS - DRAWERS NATURAL Refrigerant

Self-Cleaning Condenser Equipped Units

■ **Self-Cleaning Condenser (Patented)**

The accumulation of dust in the condenser can cause the failure or breakdown of refrigerators. Refrigerators run normally until they reach a certain level of accumulation. At some point, when they are over the limit, their performance drops quickly resulting in damage to, or disposal of the stored products inside. The Self-Cleaning Condenser device keeps the condenser clean and prevents system failure by automatically brushing daily.

■ **Digital temperature control & monitor system**

Keeps food products safe by maintaining constant temperatures. External digital display allows for easy monitoring.

■ **Hydrocarbon refrigerants (R-290)**

With innovative and eco-friendly technology, Turbo Air brings you hydrocarbon refrigerators designed to meet DOE's Energy Conservation Standards in 2017 and to use EPA's SNAP Program approved HC refrigerants. Hydrocarbon refrigerants do not deplete the ozone layer and have very low contribution to global warming (ODP-0, GWP-3).

■ **Cold Bunker system**

Our innovative forced air system allows cold air to flow all around the food pan area, covering not only underneath the pan, but also the front, top and the rear. This unique air flow creates a cold air-shield around the pan, which maintains the food temperature at under 41°F (NSF requirement) even when the lids are opened.

■ **Stainless steel cabinet construction**

The Turbo Air Super Deluxe model boasts a stainless steel interior (ABS door liner) and exterior (galvanized steel back & bottom) including durable stainless steel drawers. It guarantees the utmost in cleanliness and long product life. The Super Deluxe adds a touch of style to the most refined setting.

■ **Sturdy, clean stainless steel shelving**

Shelves are the most important part of cleanliness as they come in direct contact with food. After a while, PVC coated wire shelves may peel, rust and lead to unsanitary conditions. The Super Deluxe series uniquely provides stainless steel shelving.

■ **9-1/2" deep, 1/2" thick high-density Polyethylene cutting board included with convenient side rail**

■ **Ergonomically designed doors & drawers**

Customers' fatigue fades away with easy door grip and drawers that open effortlessly. These features along with self-closing doors make this the ultimate choice in customer convenience. ABS sheet door liners resist water condensation with thermal efficiency.



TST-60SD-08S-D2-N

Self-Cleaning Condenser
Maintenance-free during warranty period

■ **Insulated pan cover**

■ **Refrigerator holds 33°F ~ 39°F for the best in food preservation**

■ **Standard features**

- Anti-corrosion coated evaporator
- Self-contained system
- 4" dia. swivel casters with locks on the front set
- 1/6 size, 4" deep condiment pans included (top of cabinet)

■ **Optional features**

- Stainless steel single/double overshelf available
- Clear lids available
- Removable food covers available
- Legs available for all models: 6"
- Casters available for all models: 1", 2.5", 5"
- Door lock (lead time applies)

TST MODELS SPECIFICATIONS

ELECTRICAL DATA		TST-60SD-08S-D2-N
Voltage		115/60/1
Plug Type		Ⓜ NEMA 5-15P
Full Load Amp.		8.9
Compressor HP		1/5
Cord Length (ft.)		10
Refrigerant		R-290
DIMENSIONAL DATA		
Net Capacity (cu. ft.)		19
Ext. Dimension (L x D [†] x H [‡]) (in.)		60 ^{1/4} x 30 x 37 ^{1/2}
# of Doors		1
# of Drawers		2
# of Shelves (Size (L x D) (in.))		1
# of Pans		8
Net Weight (lbs.)		278
Gross Weight (lbs.)		315

Design and specifications subject to change without notice. Most updated spec sheets are available at www.turboairinc.com.

Actual shipping weight may differ due to extra packing materials for product protection.

* Depth does not include 1" for rear spacers. † Height does not include 4-1/2" for caster height.

■ **WARRANTY: 5 Year Parts and Labor Warranty, 7 Year Compressor Warranty**

SANDWICH/SALAD UNITS - DRAWERS NATURAL Refrigerant

Self-Cleaning Condenser Equipped Units

■ **Self-Cleaning Condenser (Patented)**

The accumulation of dust in the condenser can cause the failure or breakdown of refrigerators. Refrigerators run normally until they reach a certain level of accumulation. At some point, when they are over the limit, their performance drops quickly resulting in damage to, or disposal of the stored products inside. The Self-Cleaning Condenser device keeps the condenser clean and prevents system failure by automatically brushing daily.

■ **Digital temperature control & monitor system**

Keeps food products safe by maintaining constant temperatures. External digital display allows for easy monitoring.

■ **Hydrocarbon refrigerants (R-290)**

With innovative and eco-friendly technology, Turbo Air brings you hydrocarbon refrigerators designed to meet DOE's Energy Conservation Standards in 2017 and to use EPA's SNAP Program approved HC refrigerants. Hydrocarbon refrigerants do not deplete the ozone layer and have very low contribution to global warming (ODP-0, GWP-3).

■ **Cold Bunker system**

Our innovative forced air system allows cold air to flow all around the food pan area, covering not only underneath the pan, but also the front, top and the rear. This unique air flow creates a cold air-shield around the pan, which maintains the food temperature at under 41°F (NSF requirement) even when the lids are opened.

■ **Stainless steel cabinet construction**

The Turbo Air Super Deluxe model boasts a stainless steel interior (ABS door liner) and exterior (galvanized steel back & bottom) including durable stainless steel drawers. It guarantees the utmost in cleanliness and long product life. The Super Deluxe adds a touch of style to the most refined setting.

■ **Sturdy, clean stainless steel shelving**

Shelves are the most important part of cleanliness as they come in direct contact with food. After a while, PVC coated wire shelves may peel, rust and lead to unsanitary conditions. The Super Deluxe series uniquely provides stainless steel shelving (only TST-48SD-D2-N, TST-60SD-D2-N).

■ **9-1/2" deep, 1/2" thick high-density Polyethylene cutting board included with convenient side rail**

■ **Ergonomically designed doors & drawers**

Customers' fatigue fades away with easy door grip and drawers that open effortlessly. These features along with self-closing doors make this the ultimate choice in customer convenience. ABS sheet door liners resist water condensation with thermal efficiency.



TST-48SD-D2-N

Each drawer accommodates up to 6" deep sixth (1/6) size pans (drawer pans not included)



TST-28SD-D2-N

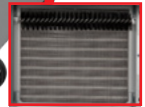

Self-Cleaning Condenser Maintenance-free during warranty period

■ **Insulated pan cover**

■ **Refrigerator holds 33°F ~ 39°F for the best in food preservation**

■ **Standard features**

- Anti-corrosion coated evaporator
- Self-contained system
- 4" dia. swivel casters with locks on the front set
- 1/6 size, 4" deep condiment pans included (top of cabinet)

■ **Optional features**

- Stainless steel single/double overself available (except TST-28SD-D2-N)
- Clear lids available
- Removable food covers available
- Legs available for all models: 6"
- Casters available for all models: 1", 2.5", 5"

TST MODELS SPECIFICATIONS

ELECTRICAL DATA	TST-28SD-D2-N	TST-48SD-D2-N	TST-48SD-D4-N	TST-60SD-D2-N	TST-60SD-D4-N	TST-72SD-D6-N
Voltage	115/60/1	115/60/1	115/60/1	115/60/1	115/60/1	115/60/1
Plug Type	Ⓢ NEMA 5-15P	Ⓢ NEMA 5-15P	Ⓢ NEMA 5-15P	Ⓢ NEMA 5-15P	Ⓢ NEMA 5-15P	Ⓢ NEMA 5-15P
Full Load Amp.	3.8	4.4	4.4	4.4	4.4	9.9
Compressor HP	1/6	1/4	1/4	1/5	1/5	3/8
Cord Length (ft.)	9	9	9	9	9	10
Refrigerant	R-290	R-290	R-290	R-290	R-290	R-290
DIMENSIONAL DATA						
Net Capacity (cu. ft.)	7	12	12	17	17	23
Ext. Dimension (L x D x H) (in.)	27 ^{1/2} x 30 ⁺ x 37 ^{1/2} †	48 ^{1/4} x 30 ⁺ x 37 ^{1/2} †	48 ^{1/4} x 30 ⁺ x 37 ^{1/2} †	60 ^{1/4} x 30 ⁺ x 37 ^{1/2} †	60 ^{1/4} x 30 ⁺ x 37 ^{1/2} †	72 ^{5/8} x 30 ⁺ x 37 ^{5/8} ‡
# of Doors	-	1	-	1	-	-
# of Drawers	2	2	4	2	4	6
# of Shelves (Size (L x D) (in.))	-	1 (21 x 17)	-	1 (27 x 17)	-	-
# of Pans	8	12	12	16	16	18
Net Weight (lbs.)	187	227	233	298	305	344
Gross Weight (lbs.)	205	249	255	337	343	372

Design and specifications subject to change without notice. Most updated spec sheets are available at www.turboairinc.com.

Actual shipping weight may differ due to extra packing materials for product protection.

* Depth does not include 1" for rear spacers. † Height does not include 4-3/4" for caster height. ‡ Height does not include 4-1/2" for caster height.

■ **WARRANTY: 5 Year Parts and Labor Warranty, 7 Year Compressor Warranty**

MEGA TOP UNITS NATURAL Refrigerant

Self-Cleaning Condenser Equipped Units

Self-Cleaning Condenser (Patented)

The accumulation of dust in the condenser can cause the failure or breakdown of refrigerators. Refrigerators run normally until they reach a certain level of accumulation. At some point, when they are over the limit, their performance drops quickly resulting in damage to, or disposal of the stored products inside. The Self-Cleaning Condenser device keeps the condenser clean and prevents system failure by automatically brushing daily.

Digital temperature control & monitor system

Keeps food products safe by maintaining constant temperatures. External digital display allows for easy monitoring.

Hydrocarbon refrigerants (R-290 / R-600a)

With innovative and eco-friendly technology, Turbo Air brings you hydrocarbon refrigerators designed to meet DOE's Energy Conservation Standards in 2017 and to use EPA's SNAP Program approved HC refrigerants. Hydrocarbon refrigerants do not deplete the ozone layer and have very low contribution to global warming (ODP-0, GWP-3).

Cold Bunker system

Our innovative forced air system allows cold air to flow all around the food pan area, covering not only underneath the pan, but also the front, top and the rear. This unique air flow creates a cold air-shield around the pan, which maintains the food temperature at under 41°F (NSF requirement) even when the lids are opened. In addition, the compartment isolates pans from the reach-in area to prevent food spillage.

Stainless steel cabinet construction

The Turbo Air Super Deluxe model boasts a stainless steel interior (ABS door liner) and exterior (galvanized steel back & bottom). It guarantees the utmost in cleanliness and long product life. The Super Deluxe adds a touch of style to the most refined setting.

Sturdy, clean stainless steel shelving

Shelves are the most important part of cleanliness as they come in direct contact with food. After a while, PVC coated wire shelves may peel, rust and lead to unsanitary conditions. The Turbo Air Super Deluxe series uniquely provides stainless steel shelving.

9-1/2" deep, 1/2" thick high-density Polyethylene cutting board included with convenient side rail

Insulated pan cover

Refrigerator holds 33°F ~ 39°F for the best in food preservation



TST-36SD-15-N6

TST-72SD-30-N

LED interior lighting & fan control

Energy efficient LED lighting lights every corner, making items easy to find. Fan control function automatically shuts off the fan when the door is open, which prevents hot air from being drawn in, thus maintaining the cool inner temperature.

Standard features

- Anti-corrosion coated evaporator
- Self-contained system
- 4" dia. swivel casters with locks on the front set
- 1/6 size, 4" deep condiment pans included
- High-density polyurethane insulation

Optional features

- Stainless steel single/double overshelf available (except TST-28SD-12-N, double overshelf only for TST-36SD-15-N6)
- Clear lids available
- Removable food covers available
- Legs available for all models: 6"
- Door locks available (extra lead time will apply)
- Casters available for all models: 1", 2.5", 5"

TST MODELS SPECIFICATIONS

ELECTRICAL DATA	TST-28SD-12-N	TST-36SD-15-N6	TST-48SD-18-N	TST-60SD-24-N	TST-72SD-30-N
Voltage	115/60/1	115/60/1	115/60/1	115/60/1	115/60/1
Plug Type	Ⓜ NEMA 5-15P	Ⓜ NEMA 5-15P	Ⓜ NEMA 5-15P	Ⓜ NEMA 5-15P	Ⓜ NEMA 5-15P
Full Load Amp.	3.8	2.9	4.4	4.4	5.7
Compressor HP	1/6	1/5	1/5	1/5	2/5
Cord Length (ft.)	9	9	9	9	9
Refrigerant	R-290	R-600a	R-290	R-290	R-290
DIMENSIONAL DATA					
Net Capacity (cu. ft.)	8	11	15	19	23
Ext. Dimension (L x D [†] x H [†]) (in.)	27 ¹ / ₂ x 34 x 39 ⁵ / ₈	36 ³ / ₈ x 34 x 39 ⁵ / ₈	48 ¹ / ₄ x 34 x 39 ⁵ / ₈	60 ¹ / ₄ x 34 x 39 ⁵ / ₈	72 ⁵ / ₈ x 34 x 39 ⁵ / ₈
# of Doors	1	2	2	2	3
# of Shelves (Size (L x D) (in.))	1 (22 ¹ / ₂ x 17)	2 (15 x 17)	2 (21 x 17)	2 (27 x 17)	3 (21 x 17 (L/R), 23 x 17 (M))
# of Pans	12	15	18	24	30
Net Weight (lbs.)	206	226	244	321	356
Gross Weight (lbs.)	220	242	264	352	396

Design and specifications subject to change without notice. Most updated spec sheets are available at www.turboairinc.com.

Actual shipping weight may differ due to extra packing materials for product protection.

* Depth does not include 3" for cutting boards and 1" for rear spacers. † Height does not include 4-3/4" for caster height.

WARRANTY: 5 Year Parts and Labor Warranty, 7 Year Compressor Warranty

MEGA TOP UNITS - DRAWERS NATURAL Refrigerant

Self-Cleaning Condenser Equipped Units

■ **Self-Cleaning Condenser (Patented)**

The accumulation of dust in the condenser can cause the failure or breakdown of refrigerators. Refrigerators run normally until they reach a certain level of accumulation. At some point, when they are over the limit, their performance drops quickly resulting in damage to, or disposal of the stored products inside. The Self-Cleaning Condenser device keeps the condenser clean and prevents system failure by automatically brushing daily.

■ **Digital temperature control & monitor system**

Keeps food products safe by maintaining constant temperatures. External digital display allows for easy monitoring.

■ **Hydrocarbon refrigerants (R-290)**

With innovative and eco-friendly technology, Turbo Air brings you hydrocarbon refrigerators designed to meet DOE's Energy Conservation Standards in 2017 and to use EPA's SNAP Program approved HC refrigerants. Hydrocarbon refrigerants do not deplete the ozone layer and have very low contribution to global warming (ODP-0, GWP-3).

■ **Cold Bunker system**

Our innovative forced air system allows cold air to flow all around the food pan area, covering not only underneath the pan, but also the front, top and the rear. This unique air flow creates a cold air-shield around the pan, which maintains the food temperature at under 41°F (NSF requirement) even when the lids are opened.

■ **Stainless steel cabinet construction**

The Turbo Air Super Deluxe model boasts a stainless steel interior (ABS door liner) and exterior (galvanized steel back & bottom) including durable stainless steel drawers. It guarantees the utmost in cleanliness and long product life. The Super Deluxe adds a touch of style to the most refined setting.

■ **Sturdy, clean stainless steel shelving**

Shelves are the most important part of cleanliness as they come in direct contact with food. After a while, PVC coated wire shelves may peel, rust and lead to unsanitary conditions. The Super Deluxe series uniquely provides stainless steel shelving (only TST-48SD-18-D2-N, TST-60SD-24-D2-N).

■ **9-1/2" deep, 1/2" thick high-density Polyethylene cutting board included with convenient side rail**

■ **Ergonomically designed doors & drawers**

Customers' fatigue fades away with easy door grip and drawers that open effortlessly. These features along with self-closing doors make this the ultimate choice in customer convenience. ABS sheet door liners resist water condensation with thermal efficiency.



TST-60SD-24-D2R-N

Each drawer accommodates up to 6" deep sixth (1/6) size pans (drawer pans not included)

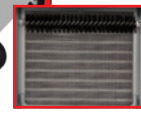

Self-Cleaning Condenser Maintenance-free during warranty period

■ **Insulated pan cover**

■ **Refrigerator holds 33°F ~ 39°F for the best in food preservation**

■ **Standard features**

- Anti-corrosion coated evaporator
- Self-contained system
- 4" dia. swivel casters with locks on the front set
- 1/6 size, 4" deep condiment pans included (top of cabinet)
- Lead time applies

■ **Optional features**

- Stainless steel single/double overshelf available (except TST-28SD-12-D2-N)
- Clear lids available
- Removable food covers available
- Legs available for all models: 6"
- Casters available for all models: 1", 2.5", 5"

TST MODELS SPECIFICATIONS

ELECTRICAL DATA	TST-60SD-24-D2R-N	TST-72SD-30-D4R-N
Voltage	115/60/1	115/60/1
Plug Type	Ⓢ NEMA 5-15P	Ⓢ NEMA 5-15P
Full Load Amp.	8.9	9.9
Compressor HP	1/5	3/8
Cord Length (ft.)	9	10
Refrigerant	R-290	R-290
DIMENSIONAL DATA		
Net Capacity (cu. ft.)	19	23
Ext. Dimension (L x D x H) (in.)	60 ^{1/4} x 34" x 39 ^{5/8} †	72 ^{5/8} x 34" x 39 ^{5/8} ‡
# of Doors	1	1
# of Drawers	2	4
# of Shelves	1	1
# of Pans	24	30
Net Weight (lbs.)	335	346
Gross Weight (lbs.)	366	386

Design and specifications subject to change without notice. Most updated spec sheets are available at www.turboairinc.com.

Actual shipping weight may differ due to extra packing materials for product protection.

* Depth does not include 3" for cutting boards and 1" for rear spacers. † Height does not include 4-3/4" for caster height. ‡ Height does not include 4-1/2" for caster height.

■ **WARRANTY: 5 Year Parts and Labor Warranty, 7 Year Compressor Warranty**

MEGA TOP UNITS - DRAWERS NATURAL Refrigerant

Self-Cleaning Condenser Equipped Units

■ **Self-Cleaning Condenser (Patented)**

The accumulation of dust in the condenser can cause the failure or breakdown of refrigerators. Refrigerators run normally until they reach a certain level of accumulation. At some point, when they are over the limit, their performance drops quickly resulting in damage to, or disposal of the stored products inside. The Self-Cleaning Condenser device keeps the condenser clean and prevents system failure by automatically brushing daily.

■ **Digital temperature control & monitor system**

Keeps food products safe by maintaining constant temperatures. External digital display allows for easy monitoring.

■ **Hydrocarbon refrigerants (R-290)**

With innovative and eco-friendly technology, Turbo Air brings you hydrocarbon refrigerators designed to meet DOE's Energy Conservation Standards in 2017 and to use EPA's SNAP Program approved HC refrigerants. Hydrocarbon refrigerants do not deplete the ozone layer and have very low contribution to global warming (ODP-0, GWP-3).

■ **Cold Bunker system**

Our innovative forced air system allows cold air to flow all around the food pan area, covering not only underneath the pan, but also the front, top and the rear. This unique air flow creates a cold air-shield around the pan, which maintains the food temperature at under 41°F (NSF requirement) even when the lids are opened.

■ **Stainless steel cabinet construction**

The Turbo Air Super Deluxe model boasts a stainless steel interior (ABS door liner) and exterior (galvanized steel back & bottom) including durable stainless steel drawers. It guarantees the utmost in cleanliness and long product life. The Super Deluxe adds a touch of style to the most refined setting.

■ **Sturdy, clean stainless steel shelving**

Shelves are the most important part of cleanliness as they come in direct contact with food. After a while, PVC coated wire shelves may peel, rust and lead to unsanitary conditions. Only the Turbo Air Super Deluxe series uniquely provides stainless steel shelving (only TST-48SD-18-D2-N, TST-60SD-24-D2-N).

■ **9-1/2" deep, 1/2" thick high-density Polyethylene cutting board included with convenient side rail**

■ **Ergonomically designed doors & drawers**

Customers' fatigue fades away with easy door grip and drawers that open effortlessly. These features along with self-closing doors make this the ultimate choice in customer convenience. ABS sheet door liners resist water condensation with thermal efficiency.



■ **Insulated pan cover**

■ **Refrigerator holds 33°F ~ 39°F for the best in food preservation**

■ **Standard features**

- Anti-corrosion coated evaporator
- Self-contained system
- 4" dia. swivel casters with locks on the front set
- 1/6 size, 4" deep condiment pans included (top of cabinet)
- Lead time applies

■ **Optional features**

- Stainless steel single/double overshelf available (except TST-28SD-12-D2-N)
- Clear lids available
- Removable food covers available
- Legs available for all models: 6"
- Casters available for all models: 1", 2.5", 5"

TST MODELS SPECIFICATIONS

ELECTRICAL DATA	TST-28SD-12-D2-N	TST-48SD-18-D2-N	TST-48SD-18-D4-N	TST-60SD-24-D2-N	TST-60SD-24-D4-N	TST-72SD-30-D6-N
Voltage	115/60/1	115/60/1	115/60/1	115/60/1	115/60/1	115/60/1
Plug Type	Ⓜ NEMA 5-15P	Ⓜ NEMA 5-15P	Ⓜ NEMA 5-15P	Ⓜ NEMA 5-15P	Ⓜ NEMA 5-15P	Ⓜ NEMA 5-15P
Full Load Amp.	3	4.4	4.4	4.3	4.3	9.9
Compressor HP	1/5	1/3	1/3	1/3	1/3	3/8
Cord Length (ft.)	9	9	9	9	9	10
Refrigerant	R-290	R-290	R-290	R-290	R-290	R-290
DIMENSIONAL DATA						
Net Capacity (cu. ft.)	8	15	15	19	19	23
Ext. Dimension (L x D x H) (in.)	27 1/2 x 34" x 39 5/8" †	48 1/4 x 34" x 39 5/8" †	48 1/4 x 34" x 39 5/8" †	60 1/4 x 34" x 39 5/8" †	60 1/4 x 34" x 39 5/8" †	72 5/8 x 34" x 39 5/8" ‡
# of Doors	-	1	-	1	-	-
# of Drawers	2	2	4	2	4	6
# of Shelves (Size (L x D) (in.))	-	1 (21 x 17)	-	1 (27 x 17)	-	-
# of Pans	12	18	18	24	24	30
Net Weight (lbs.)	223	254	264	335	344	356
Gross Weight (lbs.)	237	276	286	366	375	396

Design and specifications subject to change without notice. Most updated spec sheets are available at www.turboairinc.com.

Actual shipping weight may differ due to extra packing materials for product protection.

* Depth does not include 3" for cutting boards and 1" for rear spacers. † Height does not include 4-3/4" for caster height. ‡ Height does not include 4-1/2" for caster height.

■ **WARRANTY: 5 Year Parts and Labor Warranty, 7 Year Compressor Warranty**

MEGA TOP UNITS - DRAWERS/FLAT LID NATURAL Refrigerant

Self-Cleaning Condenser Equipped Units

■ **Self-Cleaning Condenser (Patented)**

The accumulation of dust in the condenser can cause the failure or breakdown of refrigerators. Refrigerators run normally until they reach a certain level of accumulation. At some point, when they are over the limit, their performance drops quickly resulting in damage to, or disposal of the stored products inside. The Self-Cleaning Condenser device keeps the condenser clean and prevents system failure by automatically brushing daily.

■ **Digital temperature control & monitor system**

Keeps food products safe by maintaining constant temperatures. External digital display allows for easy monitoring.

■ **Hydrocarbon refrigerants (R-290)**

With innovative and eco-friendly technology, Turbo Air brings you hydrocarbon refrigerators designed to meet DOE's Energy Conservation Standards in 2017 and to use EPA's SNAP Program approved HC refrigerants. Hydrocarbon refrigerants do not deplete the ozone layer and have very low contribution to global warming (ODP-0, GWP-3).

■ **Cold Bunker system**

Our innovative forced air system allows cold air to flow all around the food pan area, covering not only underneath the pan, but also the front, top and the rear. This unique air flow creates a cold air-shield around the pan, which maintains the food temperature at under 41°F (NSF requirement) even when the lids are opened. In addition, the compartment isolates pans from the reach-in area to prevent food spillage.

■ **Stainless steel cabinet construction**

The Turbo Air Super Deluxe model boasts a stainless steel interior (ABS door liner) and exterior (galvanized steel back & bottom). It guarantees the utmost in cleanliness and long product life. The Super Deluxe adds a touch of style to the most refined setting.

■ **Sturdy, clean stainless steel shelving**

Shelves are the most important part of cleanliness as they come in direct contact with food. After a while, PVC coated wire shelves may peel, rust and lead to unsanitary conditions. The Super Deluxe series uniquely provides stainless steel shelving.

■ **9-1/2" deep, 1/2" thick high-density Polyethylene cutting board included with convenient side rail**

■ **Refrigerator holds 33°F ~ 39°F for the best in food preservation**



TST-48SD-18-D2R-N-FL

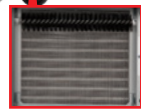

Self-Cleaning Condenser
Maintenance-free during warranty period

■ **Standard features**

- Anti-corrosion coated evaporator
- Self-contained system
- 4" dia. swivel casters with locks on the front set
- 1/6 size, 4" deep condiment pans included

■ **Optional features**

- Legs available for all models: 6"
- Door locks available (extra lead time will apply)
- Casters available for all models: 1", 2.5", 5"

TST MODELS SPECIFICATIONS

ELECTRICAL DATA	TST-48SD-18-D2R-N-FL	TST-48SD-18-D4-N-FL	TST-72SD-30-D6-N-FL
Voltage	115/60/1	115/60/1	115/60/1
Plug Type	Ⓢ NEMA 5-15P	Ⓢ NEMA 5-15P	Ⓢ NEMA 5-15P
Full Load Amp.	6.5	6.5	9.9
Compressor HP	1/5	1/5	3/8
Cord Length (ft.)	10	10	10
Refrigerant	R-290	R-290	R-290
DIMENSIONAL DATA			
Net Capacity (cu. ft.)	12	12	23
Ext. Dimension (L x D x H†) (in.)	48 1/4 x 34* x 32 7/8†	48 1/4 x 34* x 32 7/8†	72 5/8 x 34 x 33 1/2‡
# of Doors	1	-	-
# of Shelves	1	-	-
# of Pans	18	18	30
Net Weight (lbs.)	244	254	356
Gross Weight (lbs.)	266	276	386

Design and specifications subject to change without notice. Most updated spec sheets are available at www.turboairinc.com.

Actual shipping weight may differ due to extra packing materials for product protection.

* Depth does not include 3" for rear spacers. † Height does not include 5-1/8" for caster height. ‡ Height does not include 4-1/2" for caster height.

■ **WARRANTY: 5 Year Parts and Labor Warranty, 7 Year Compressor Warranty**

MEGA TOP UNITS - DRAWERS/GLASS LID NATURAL Refrigerant

Self-Cleaning Condenser Equipped Units

■ **Self-Cleaning Condenser (Patented)**

The accumulation of dust in the condenser can cause the failure or breakdown of refrigerators. Refrigerators run normally until they reach a certain level of accumulation. At some point, when they are over the limit, their performance drops quickly resulting in damage to, or disposal of the stored products inside. The Self-Cleaning Condenser device keeps the condenser clean and prevents system failure by automatically brushing the condenser daily.

■ **Digital temperature control & monitor system**

Keeps food products safe by maintaining constant temperatures. External digital display allows for easy monitoring.

■ **Hydrocarbon refrigerants (R-290)**

With innovative and eco-friendly technology, Turbo Air brings you hydrocarbon refrigerators designed to meet DOE's Energy Conservation Standards in 2017 and to use EPA's SNAP Program approved HC refrigerants. Hydrocarbon refrigerants do not deplete the ozone layer and have very low contribution to global warming (ODP-0, GWP-3).

■ **Cold Bunker system**

Our innovative forced air system allows cold air to flow all around the food pan area, covering not only underneath the pan, but also the front, top and the rear. This unique air flow creates a cold air-shield around the pan, which maintains the food temperature at under 41°F (NSF requirement) even when the lids are opened. In addition, the compartment isolates pans from the reach-in area to prevent food spillage.

■ **Stainless steel cabinet construction**

The Turbo Air Super Deluxe model boasts a stainless steel interior (ABS door liner) and exterior (galvanized steel back & bottom). It guarantees the utmost in cleanliness and long product life. The Super Deluxe adds a touch of style to the most refined setting.

■ **Sturdy, clean stainless steel shelving**

Shelves are the most important part of cleanliness as they come in direct contact with food. After a while, PVC coated wire shelves may peel, rust and lead to unsanitary conditions. The Super Deluxe series uniquely provides stainless steel shelving.

■ **6-1/4" deep, 1/2" thick high-density Polyethylene cutting board included with convenient side rail**

■ **Each drawer accommodated up to 6" deep, two (2) 1/3 size pans or four (4) 1/6 size pans (drawer pans not included)**

■ **Refrigerator holds 33°F ~ 39°F for the best in food preservation**



TST-48SD-18-D2R-N-GL

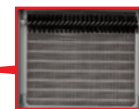

Self-Cleaning Condenser
Maintenance-free during warranty period



TST-72SD-30-D6-N-GL

■ **Standard features**

- Anti-corrosion coated evaporator
- Self-contained system
- 4" dia. swivel casters with locks on the front set
- 1/6 size, 4" deep condiment pans included (top of cabinet)

■ **Optional features**

- Legs available for all models: 6"
- Casters available for all models: 1", 2.5", 5"

TST MODELS SPECIFICATIONS

ELECTRICAL DATA	TST-48SD-18-D2R(L)-N-GL	TST-48SD-18-D4-N-GL	TST-72SD-30-D6-N-GL
Voltage	115/60/1	115/60/1	115/60/1
Plug Type	Ⓜ NEMA 5-15P	Ⓜ NEMA 5-15P	Ⓜ NEMA 5-15P
Full Load Amp.	6.5	6.5	9.9
Compressor HP	1/5	1/5	3/8
Cord Length (ft.)	10	10	10
Refrigerant	R-290	R-290	R-290
DIMENSIONAL DATA			
Net Capacity (cu. ft.)	15	19	19
Ext. Dimension (L x D x H†) (in.)	48 1/4 x 34* x 31 1/4†	48 1/4 x 34* x 31 1/4†	72 5/8 x 36 7/8 x 31 3/4‡
# of Doors	1	-	-
# of Shelves (Size (L x D) (in.))	1	-	-
# of Pans	18	18	30
Net Weight (lbs.)	264	274	366
Gross Weight (lbs.)	286	296	396

Design and specifications subject to change without notice. Most updated spec sheets are available at www.turboairinc.com.

Actual shipping weight may differ due to extra packing materials for product protection.

* Depth does not include 1-7/8" for cutting boards and 1" for rear spacers. † Height does not include 5-1/8" for caster height. ‡ Height does not include 4-1/2" for caster height.

■ **WARRANTY: 5 Year Parts and Labor Warranty, 7 Year Compressor Warranty**

MEGA TOP UNITS - DRAWERS/SLIDE BACK LID NATURAL Refrigerant

Self-Cleaning Condenser Equipped Units

■ **Self-Cleaning Condenser (Patented)**

The accumulation of dust in the condenser can cause the failure or breakdown of refrigerators. Refrigerators run normally until they reach a certain level of accumulation. At some point, when they are over the limit, their performance drops quickly resulting in damage to, or disposal of the stored products inside. The Self-Cleaning Condenser device keeps the condenser clean and prevents system failure by automatically brushing daily.

■ **Digital temperature control & monitor system**

Keeps food products safe by maintaining constant temperatures. External digital display allows for easy monitoring.

■ **Hydrocarbon refrigerants (R-290)**

With innovative and eco-friendly technology, Turbo Air brings you hydrocarbon refrigerators designed to meet DOE's Energy Conservation Standards in 2017 and to use EPA's SNAP Program approved HC refrigerants. Hydrocarbon refrigerants do not deplete the ozone layer and have very low contribution to global warming (ODP-0, GWP-3).

■ **Cold Bunker system**

Our innovative forced air system allows cold air to flow all around the food pan area, covering not only underneath the pan, but also the front, top and the rear. This unique air flow creates a cold air-shield around the pan, which maintains the food temperature at under 41°F (NSF requirement) even when the lids are opened.

■ **Stainless steel cabinet construction**

The Turbo Air Super Deluxe model boasts a stainless steel interior (ABS door liner) and exterior (galvanized steel back & bottom) including durable stainless steel drawers. It guarantees the utmost in cleanliness and long product life. The Super Deluxe adds a touch of style to the most refined setting.

■ **Sturdy, clean stainless steel shelving**

Shelves are the most important part of cleanliness as they come in direct contact with food. After a while, PVC coated wire shelves may peel, rust and lead to unsanitary conditions. The Super Deluxe series uniquely provides stainless steel shelving.

■ **9-1/2" deep, 1/2" thick high-density Polyethylene cutting board included with convenient side rail**

■ **Refrigerator holds 33°F ~ 39°F for the best in food preservation**



TST-72SD-30-D6-N-SL

Self-Cleaning Condenser
Maintenance-free during warranty period

■ **Standard features**

- Anti-corrosion coated evaporator
- Self-contained system
- 4" dia. swivel casters with locks on the front set
- 1/6 size, 4" deep condiment pans included (top of cabinet)

■ **Optional features**

- Clear lids available (except TST-72SD-30-D6-N-SL)
- Legs available for all models: 6"
- Casters available for all models: 1", 2.5", 5"

TST MODELS SPECIFICATIONS

ELECTRICAL DATA	TST-28SD-12-D2-N-SL	TST-72SD-30-D6-N-SL
Voltage	115/60/1	115/60/1
Plug Type	Ⓢ NEMA 5-15P	Ⓢ NEMA 5-15P
Full Load Amp.	3.0	9.9
Compressor HP	1/5	3/8
Cord Length (ft.)	9	10
Refrigerant	R-290	R-290
DIMENSIONAL DATA		
Net Capacity (cu. ft.)	8	23
Ext. Dimension (L x D [†] x H [†]) (in.)	27 1/2 x 37 x 44 1/8	72 5/8 x 34 x 39 5/8
# of Doors	-	-
# of Drawers	2	6
# of Shelves (Size (L x D) (in.))	-	-
# of Pans	12	30
Net Weight (lbs.)	223	356
Gross Weight (lbs.)	237	386

Design and specifications subject to change without notice. Most updated spec sheets are available at www.turboairinc.com.

Actual shipping weight may differ due to extra packing materials for product protection.

* Depth does not include 3" for cutting board and 1-1/4" for rear spacers. † Height does not include 4-1/2" for caster height.

■ **WARRANTY: 5 Year Parts and Labor Warranty, 7 Year Compressor Warranty**

MEGA TOP UNITS - SPECIALTY LIDS NATURAL Refrigerant

Self-Cleaning Condenser Equipped Units



TST Mega Top CL

Clear Lids



TST Mega Top GL

Glass Lids
6-1/4" deep cutting board



TST Mega Top FL

Flat Lids



TST Mega Top SL

Slide Back Lids



TST Mega Top DS

Dual Sided Lids



TST Mega Top Extend

Extended Countertop

Model	Ext. dimension (L x D* x H†) (in.)	Net / Gross Weight (lbs.)
TST-48SD-18-N-CL	48 1/4 x 34 x 39 5/8	249 / 267
TST-60SD-24-N-CL	60 1/4 x 34 x 39 5/8	323 / 356
TST-72SD-30-N-CL	72 5/8 x 34 x 39 5/8	358 / 399

See page 119 for specification.

Model	Ext. dimension (L x D x H†) (in.)	Net / Gross Weight (lbs.)
TST-28SD-12-N-GL	28 x 37*** x 31 3/4	216 / 220
TST-48SD-18-N-GL	48 1/4 x 34 5/8*** x 32 5/8	260 / 275
TST-60SD-24-N-GL	60 1/4 x 34 5/8** x 32 5/8	335 / 355
TST-72SD-30-N-GL	72 5/8 x 34 5/8** x 32 5/8	370 / 400

See page 119 for specification.

Model	Ext. dimension (L x D* x H†) (in.)	Net / Gross Weight (lbs.)
TST-48SD-18-N-FL	48 1/4 x 34 x 33 1/2	244 / 264
TST-60SD-24-N-FL	60 1/4 x 34 x 33 1/2	321 / 352
TST-72SD-30-N-FL	72 5/8 x 34 x 33 1/2	356 / 396

See page 119 for specification.

Model	Ext. dimension (L x D* x H†) (in.)	Net / Gross Weight (lbs.)
TST-28SD-12-N-SL	27 1/2 x 34 x 39 5/8	205 / 220
TST-36SD-15-N-SL	36 1/4 x 34 x 39 5/8	246 / 262
TST-48SD-18-N-SL	48 1/4 x 34 x 39 5/8	245 / 265
TST-60SD-24-N-SL	60 1/4 x 34 x 39 5/8	320 / 350
TST-72SD-30-N-SL	72 5/8 x 34 x 39 5/8	355 / 395

See page 119 for specification.

Model	Ext. dimension (L x D x H†) (in.)	Net / Gross Weight (lbs.)
TST-48SD-18-N-DS	48 1/4 x 46 1/2 x 40 5/8	265 / 290
TST-60SD-24-N-DS	60 1/4 x 46 1/2 x 40 5/8	345 / 380
TST-72SD-30-N-DS	72 5/8 x 46 1/2 x 40 5/8	375 / 410

See page 119 for specification.

Model	Ext. dimension (L x D* x H†) (in.)	Net / Gross Weight (lbs.)
TST-48SD-18-E-N	72 5/8 x 34 x 39 5/8	256 / 276
TST-48SD-18-E-SVC-N	72 5/8 x 34 x 39 5/8	255 / 275

See page 119 for specification.

Design and specifications subject to change without notice. Most updated spec sheets are available at www.turboairinc.com.

Actual shipping weight may differ due to extra packing materials for product protection.

* Depth does not include 3" for cutting boards and 1" or 1-1/4" for rear spacers. ** Depth does not include 1" for cutting boards and 1" for rear spacers.

*** Depth does not include 1-7/8" or 2" for cutting boards. † Height does not include 4-1/2" or 5" for caster height.

■ **WARRANTY: 5 Year Parts and Labor Warranty, 7 Year Compressor Warranty**

SANDWICH/SALAD UNITS NATURAL Refrigerant

Self-Cleaning Condenser Equipped Units

Self-Cleaning Condenser (Patented)

The accumulation of dust in the condenser can cause the failure or breakdown of refrigerators. Refrigerators run normally until they reach a certain level of accumulation. At some point, when they are over the limit, their performance drops quickly resulting in damage to, or disposal of the stored products inside. The Self-Cleaning Condenser device keeps the condenser clean and prevents system failure by automatically brushing daily.

Digital temperature control & monitor system

Keeps food products safe by maintaining constant temperatures. External digital display allows for easy monitoring.

Hydrocarbon refrigerants (R-290)

With innovative and eco-friendly technology, Turbo Air brings you hydrocarbon refrigerators designed to meet DOE's Energy Conservation Standards in 2017 and to use EPA's SNAP Program approved HC refrigerants. Hydrocarbon refrigerants do not deplete the ozone layer and have very low contribution to global warming (ODP-0, GWP-3).

Cold Bunker system

Our innovative forced air system allows cold air to flow all around the food pan area, covering not only underneath the pan, but also the front, top and the rear. This unique air flow creates a cold air-shield around the pan, which maintains the food temperature at under 41°F (NSF requirement) even when the lids are opened. In addition, the compartment isolates pans from the reach-in area to prevent food spillage.

Stainless steel cabinet construction

The Turbo Air Super Deluxe model boasts a stainless steel interior (ABS door liner) and exterior (galvanized steel back & bottom). It guarantees the utmost in cleanliness and long product life. The Super Deluxe adds a touch of style to the most refined setting.

Sturdy, clean stainless steel shelving

Shelves are the most important part of cleanliness as they come in direct contact with food. After a while, PVC coated wire shelves may peel, rust and lead to unsanitary conditions. The Super Deluxe series uniquely provides stainless steel shelving.

High-density polyurethane insulation

The entire cabinet structure and solid doors are foamed-in-place high density, CFC free polyurethane insulation.

9-1/2" deep, 1/2" thick high-density Polyethylene cutting board included with convenient side rail

Insulated pan cover

Refrigerator holds 33°F ~ 39°F for the best in food preservation



LED interior lighting & fan control

Energy efficient LED lighting lights every corner, making items easy to find. Fan control function automatically shuts off the fan when the door is open, which prevents hot air from being drawn in, thus maintaining the cool inner temperature.

Standard features

- Anti-corrosion coated evaporator
- Self-contained system
- 4" dia. swivel casters with locks on the front set
- 1/6 size, 4" deep condiment pans included
- Lead time applies

Optional features

- Stainless steel single/double overshelf available
- Removable food covers available
- Legs available for all models: 6"
- Door locks available (extra lead time will apply)
- Casters available for all models: 1", 2.5", 5"

TST MODELS SPECIFICATIONS

ELECTRICAL DATA	TST-48SD-08S-N(-LW)	TST-60SD-08S-N(-LW)	TST-72SD-08S-N(-LW)	TST-72SD-10S-N(-LW)	TST-72SD-12S-N(-LW)
Voltage	115/60/1	115/60/1	115/60/1	115/60/1	115/60/1
Plug Type	Ⓜ NEMA 5-15P	Ⓜ NEMA 5-15P	Ⓜ NEMA 5-15P	Ⓜ NEMA 5-15P	Ⓜ NEMA 5-15P
Full Load Amp.	6.5	8.9	9.9	9.9	9.9
Compressor HP	1/5	1/5	3/8	3/8	3/8
Cord Length (ft.)	10	10	10	10	10
Refrigerant	R-290	R-290	R-290	R-290	R-290
DIMENSIONAL DATA					
Net Capacity (cu. ft.)	15	19	23	23	23
Ext. Dimension (L x D ^o x H [†]) (in.)	48 1/4 x 30 x 37 5/8	60 1/4 x 30 x 37 5/8	72 5/8 x 30 x 37 5/8	72 5/8 x 30 x 37 5/8	72 5/8 x 30 x 37 5/8
# of Doors	2	2	3	3	3
# of Shelves (Size (L x D) (in.))	2 (21 x 17)	2 (27 x 17)	3 (21 x 17 (L/R), 23 x 17 (M))	3 (21 x 17 (L/R), 23 x 17 (M))	3 (21 x 17 (L/R), 23 x 17 (M))
# of Pans	8	8	8	10	12
Net Weight (lbs.)	239	280	352	352	352
Gross Weight (lbs.)	269	312	392	392	392

Design and specifications subject to change without notice. Most updated spec sheets are available at www.turboairinc.com.

Actual shipping weight may differ due to extra packing materials for product protection.

* Depth does not include 1" for rear spacers. † Height does not include 4-1/2" for caster height.

WARRANTY: 5 Year Parts and Labor Warranty, 7 Year Compressor Warranty

SANDWICH/SALAD UNITS - SPECIALTY LIDS NATURAL Refrigerant

Self-Cleaning Condenser Equipped Units



Prep + Work Stations - CL

Clear Lids
No left side workstation option

Model	Ext. dimension (L x D* x H†) (in.)	Net / Gross Weight (lbs.)
TST-48SD-08S-N-CL	48 1/4 x 30 x 37 5/8	239 / 269
TST-60SD-08S-N-CL	60 1/4 x 30 x 37 5/8	280 / 312
TST-72SD-08S-N-CL	72 5/8 x 30 x 37 5/8	352 / 392
TST-72SD-10S-N-CL	72 5/8 x 30 x 37 5/8	352 / 392
TST-72SD-12S-N-CL	72 5/8 x 30 x 37 5/8	352 / 392

See page 126 for specification.



Prep + Work Stations - FL

Flat Lids
No left side workstation option

Model	Ext. dimension (L x D* x H†) (in.)	Net / Gross Weight (lbs.)
TST-48SD-08S-N-FL	48 1/4 x 30 x 33 1/2	239 / 269
TST-60SD-08S-N-FL	60 1/4 x 30 x 33 1/2	280 / 312
TST-72SD-08S-N-FL	72 5/8 x 30 x 33 1/2	352 / 392
TST-72SD-10S-N-FL	72 5/8 x 30 x 33 1/2	352 / 392
TST-72SD-12S-N-FL	72 5/8 x 30 x 33 1/2	352 / 392

See page 126 for specification.



Prep + Work Stations - FCL

Flat Clear Lids
No left side workstation option

Model	Ext. dimension (L x D* x H†) (in.)	Net / Gross Weight (lbs.)
TST-48SD-08S-N-FCL	48 1/4 x 30 x 33 1/8	239 / 269
TST-60SD-08S-N-FCL	60 1/4 x 30 x 33 1/8	280 / 312
TST-72SD-08S-N-FCL	72 5/8 x 30 x 33 1/8	352 / 392
TST-72SD-10S-N-FCL	72 5/8 x 30 x 33 1/8	352 / 392
TST-72SD-12S-N-FCL	72 5/8 x 30 x 33 1/8	352 / 392

See page 126 for specification.

Design and specifications subject to change without notice. Most updated spec sheets are available at www.turboairinc.com.

Actual shipping weight may differ due to extra packing materials for product protection.

* Depth does not include 1" for rear spacers. † Height does not include 4-1/2" for caster height.

■ **WARRANTY: 5 Year Parts and Labor Warranty, 7 Year Compressor Warranty**

MEGA TOP UNITS NATURAL Refrigerant

Self-Cleaning Condenser Equipped Units

■ **Self-Cleaning Condenser (Patented)**

The accumulation of dust in the condenser can cause the failure or breakdown of refrigerators. Refrigerators run normally until they reach a certain level of accumulation. At some point, when they are over the limit, their performance drops quickly resulting in damage to, or disposal of the stored products inside. The Self-Cleaning Condenser device keeps the condenser clean and prevents system failure by automatically brushing daily.

■ **Digital temperature control & monitor system**

Keeps food products safe by maintaining constant temperatures. External digital display allows for easy monitoring.

■ **Hydrocarbon refrigerants (R-290)**

With innovative and eco-friendly technology, Turbo Air brings you hydrocarbon refrigerators designed to meet DOE's Energy Conservation Standards in 2017 and to use EPA's SNAP Program approved HC refrigerants. Hydrocarbon refrigerants do not deplete the ozone layer and have very low contribution to global warming (ODP-0, GWP-3).

■ **Cold Bunker system**

Our innovative forced air system allows cold air to flow all around the food pan area, covering not only underneath the pan, but also the front, top and the rear. This unique air flow creates a cold air-shield around the pan, which maintains the food temperature at under 41°F (NSF requirement) even when the lids are opened. In addition, the compartment isolates pans from the reach-in area to prevent food spillage.

■ **Stainless steel cabinet construction**

The Turbo Air Super Deluxe model boasts a stainless steel interior (ABS door liner) and exterior (galvanized steel back & bottom). It guarantees the utmost in cleanliness and long product life. The Super Deluxe adds a touch of style to the most refined setting.

■ **Sturdy, clean stainless steel shelving**

Shelves are the most important part of cleanliness as they come in direct contact with food. After a while, PVC coated wire shelves may peel, rust and lead to unsanitary conditions. The Super Deluxe series uniquely provides stainless steel shelving.

■ **High-density polyurethane insulation**

The entire cabinet structure and solid doors are foamed-in-place high density, CFC free polyurethane insulation.

■ **9-1/2" deep, 1/2" thick high-density Polyethylene cutting board included with convenient side rail**

■ **Insulated pan cover**

■ **Refrigerator holds 33°F ~ 39°F for the best in food preservation**



TST-48SD-12M-N

TST-60SD-12M-N-LW

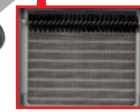

Self-Cleaning Condenser
Maintenance-free during warranty period

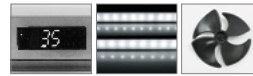

LED interior lighting & fan control

Energy efficient LED lighting lights every corner, making items easy to find. Fan control function automatically shuts off the fan when the door is open, which prevents hot air from being drawn in, thus maintaining the cool inner temperature.

■ **Standard features**

- Anti-corrosion coated evaporator
- Self-contained system
- 4" dia. swivel casters with locks on the front set
- 1/6 size, 4" deep condiment pans included
- Lead time applies

■ **Optional features**

- Stainless steel single/double overself available
- Removable food covers available
- Legs available for all models: 6"
- Door locks available (extra lead time will apply)
- Casters available for all models: 1", 2.5", 5"

TST MODELS SPECIFICATIONS

ELECTRICAL DATA	TST-48SD-12M-N(-LW)	TST-60SD-12M-N(-LW)	TST-60SD-18M-N(-LW)	TST-72SD-15M-N(-LW)	TST-72SD-18M-N(-LW)
Voltage	115/60/1	115/60/1	115/60/1	115/60/1	115/60/1
Plug Type	Ⓜ NEMA 5-15P	Ⓜ NEMA 5-15P	Ⓜ NEMA 5-15P	Ⓜ NEMA 5-15P	Ⓜ NEMA 5-15P
Full Load Amp.	6.5	8.9	8.9	9.9	9.9
Compressor HP	1/5	1/5	1/5	3/8	3/8
Cord Length (ft.)	10	10	10	10	10
Refrigerant	R-290	R-290	R-290	R-290	R-290
DIMENSIONAL DATA					
Net Capacity (cu. ft.)	15	19	19	23	23
Ext. Dimension (L x D x H†) (in.)	48 1/4 x 34 x 39 5/8	60 1/4 x 34 x 39 5/8	60 1/4 x 34 x 39 5/8	72 5/8 x 34 x 39 5/8	72 5/8 x 34 x 39 5/8
# of Doors	2	2	2	3	3
# of Shelves (Size (L x D) (in.))	2 (21 x 17)	2 (27 x 17)	2 (27 x 17)	3 (21 x 17 (L/R), 23 x 17 (M))	3 (21 x 17 (L/R), 23 x 17 (M))
# of Pans	12	12	18	15	18
Net Weight (lbs.)	239	280	321	352	356
Gross Weight (lbs.)	269	312	352	392	396

Design and specifications subject to change without notice. Most updated spec sheets are available at www.turboairinc.com.

Actual shipping weight may differ due to extra packing materials for product protection.

* Depth does not include 3" for cutting boards and 1" for rear spacers. † Height does not include 4-1/2" for caster height.

■ **WARRANTY: 5 Year Parts and Labor Warranty, 7 Year Compressor Warranty**

MEGA TOP UNITS - SPECIALTY LIDS NATURAL Refrigerant

Self-Cleaning Condenser Equipped Units



Prep + Work Stations - CL

Clear Lids
Right or left side workstation option



Prep + Work Stations - FL

Flat Lids
Right or left side workstation option



Prep + Work Stations - FCL

Flat Clear Lids
Right or left side workstation option



Prep + Work Stations - GL

Glass Lids
6-1/4" deep cutting board
Right or left side workstation option



Prep + Work Stations - SL

Slide Back Lids
Right or left side workstation option

Model	Ext. dimension (L x D* x H†) (in.)	Net / Gross Weight (lbs.)
-------	------------------------------------	---------------------------

TST-48SD-12M-N-CL(-LW)	48 1/4 x 34 x 39 5/8	239 / 269
TST-60SD-12M-N-CL(-LW)	60 1/4 x 34 x 39 5/8	280 / 312
TST-72SD-15M-N-CL(-LW)	72 5/8 x 34 x 39 5/8	352 / 392

See page 128 for specification.

Model	Ext. dimension (L x D* x H†) (in.)	Net / Gross Weight (lbs.)
-------	------------------------------------	---------------------------

TST-48SD-12M-N-FL(-LW)	48 1/4 x 34 x 33 1/2	239 / 269
TST-60SD-12M-N-FL(-LW)	60 1/4 x 34 x 33 1/2	280 / 312
TST-72SD-15M-N-FL(-LW)	72 5/8 x 34 x 33 1/2	352 / 392

See page 128 for specification.

Model	Ext. dimension (L x D* x H†) (in.)	Net / Gross Weight (lbs.)
-------	------------------------------------	---------------------------

TST-48SD-12M-N-FCL(-LW)	48 1/4 x 34 x 33 1/8	239 / 269
TST-60SD-12M-N-FCL(-LW)	60 1/4 x 34 x 33 1/8	280 / 312
TST-72SD-15M-N-FCL(-LW)	72 5/8 x 34 x 33 1/8	352 / 392

See page 128 for specification.

Model	Ext. dimension (L x D** x H†) (in.)	Net / Gross Weight (lbs.)
-------	-------------------------------------	---------------------------

TST-60SD-18M-N-GL(-LW)	60 1/4 x 34 5/8 x 32 5/8	328 / 359
TST-72SD-18M-N-GL(-LW)	72 5/8 x 34 5/8 x 32 5/8	351 / 376

See page 128 for specification.

Model	Ext. dimension (L x D** x H†) (in.)	Net / Gross Weight (lbs.)
-------	-------------------------------------	---------------------------

TST-48SD-12M-N-SL(-LW)	48 1/4 x 34 x 39 5/8	249 / 279
TST-60SD-12M-N-SL(-LW)	60 1/4 x 34 x 39 5/8	290 / 322
TST-60SD-18M-N-SL(-LW)	60 1/4 x 34 x 39 5/8	331 / 368
TST-72SD-15M-N-SL(-LW)	72 5/8 x 34 x 39 5/8	362 / 402
TST-72SD-18M-N-SL(-LW)	72 5/8 x 34 x 39 5/8	366 / 406

See page 128 for specification.

Design and specifications subject to change without notice. Most updated spec sheets are available at www.turboairinc.com.

Actual shipping weight may differ due to extra packing materials for product protection.

* Depth does not include 3" for cutting boards and 1" for rear spacers. ** Depth does not include 2" for cutting boards. † Height does not include 4-1/2" or 5" for caster height.

■ **WARRANTY: 5 Year Parts and Labor Warranty, 7 Year Compressor Warranty**

SANDWICH/SALAD UNITS - FRONT BREATHING AIRFLOW

Self-Cleaning Condenser Equipped Units

■ **Self-Cleaning Condenser (Patented)**

The accumulation of dust in the condenser can cause the failure or breakdown of refrigerators. Refrigerators run normally until they reach a certain level of accumulation. At some point, when they are over the limit, their performance drops quickly resulting in damage to, or disposal of the stored products inside. The Self-Cleaning Condenser device keeps the condenser clean and prevents system failure by automatically brushing daily.

■ **Digital temperature control & monitor system**

Keeps food products safe by maintaining constant temperatures. External digital display allows for easy monitoring.

■ **Front Breathing airflow**

Front Breathing airflow is designed to draw in air and discharge from the front, allowing units to run at high efficiency in tight spaces and eliminates the need for surrounding clearances.

■ **Hydrocarbon refrigerants (R-290)**

With innovative and eco-friendly technology, Turbo Air brings you hydrocarbon refrigerators designed to meet DOE's Energy Conservation Standards in 2017 and to use EPA's SNAP Program approved HC refrigerants. Hydrocarbon refrigerants do not deplete the ozone layer and have very low contribution to global warming (ODP-0, GWP-3).

■ **Stainless steel cabinet construction**

The Turbo Air Super Deluxe model boasts a stainless steel interior (ABS door liner) and exterior (galvanized steel back & bottom). It guarantees the utmost in cleanliness and long product life. The Super Deluxe adds a touch of style to the most refined setting.

■ **Sturdy, clean stainless steel shelving**

Shelves are the most important part of cleanliness as they come in direct contact with food. After a while, PVC coated wire shelves may peel, rust and lead to unsanitary conditions. The Super Deluxe series uniquely provides stainless steel shelving.

■ **High-density polyurethane insulation**

The entire cabinet structure and solid doors are foamed-in-place high density, CFC free polyurethane insulation.

■ **9-1/2" deep, 1/2" thick high-density Polyethylene cutting board included with convenient side rail**

■ **Insulated pan cover**

■ **Refrigerator holds 33°F ~ 39°F for the best in food preservation**

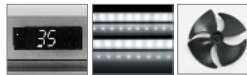

■ **LED interior lighting & fan control**

Energy efficient LED lighting lights every corner, making items easy to find. Fan control function automatically shuts off the fan when the door is open, which prevents hot air from being drawn in, thus maintaining the cool inner temperature.

■ **Standard features**

- Anti-corrosion coated evaporator
- Self-contained system
- 4" dia. swivel casters with locks on the front set
- 1/6 size, 4" deep condiment pans included

■ **Optional features**

- Stainless steel single/double overshelf available (except TST-28SD-FB-N)
- Removable food covers available
- Legs available for all models: 6"
- Door locks available (extra lead time will apply)
- Casters available for all models: 1" / 2.5" (except TST-28SD-FB-N), 5"

TST MODELS SPECIFICATIONS

ELECTRICAL DATA	TST-28SD-FB-N	TST-36SD-FB-N	TST-48SD-FB-N	TST-60SD-FB-N	TST-72SD-FB-N
Voltage	115/60/1	115/60/1	115/60/1	115/60/1	115/60/1
Plug Type	Ⓜ NEMA 5-15P	Ⓜ NEMA 5-15P	Ⓜ NEMA 5-15P	Ⓜ NEMA 5-15P	Ⓜ NEMA 5-15P
Full Load Amp.	3.8	3.8	4.4	4.4	5.7
Compressor HP	1/5	1/6	1/3	1/3	2/5
Cord Length (ft.)	10	10	10	10	10
Refrigerant	R-290	R-290	R-290	R-290	R-290
DIMENSIONAL DATA					
Net Capacity (cu. ft.)	6.5	8.8	11.1	14.8	17.6
Ext. Dimension (L x D x H†) (in.)	27 1/2 x 30 x 37 5/8	36 1/4 x 30 x 37 5/8	48 1/4 x 30 x 37 5/8	60 1/4 x 30 x 37 5/8	72 5/8 x 30 x 37 5/8
# of Doors	1	2	2	2	3
# of Shelves (Size (L x D) (in.))	1 (22 1/2 x 17)	2 (15 x 17)	2 (21 x 17)	2 (27 x 17)	3 (21 x 17 (L/R), 23 x 17 (M))
# of Pans	8	10	12	16	18
Net Weight (lbs.)	170	157	243	284	344
Gross Weight (lbs.)	195	230	273	316	372

Design and specifications subject to change without notice. Most updated spec sheets are available at www.turboairinc.com.

Actual shipping weight may differ due to extra packing materials for product protection.

† Height does not include 4-1/2" for caster height.

■ **WARRANTY: 5 Year Parts and Labor Warranty, 7 Year Compressor Warranty**

SANDWICH/SALAD UNITS - FRONT BREATHING AIRFLOW/ DRAWERS

Self-Cleaning Condenser Equipped Units

■ **Self-Cleaning Condenser (Patented)**

The accumulation of dust in the condenser can cause the failure or breakdown of refrigerators. Refrigerators run normally until they reach a certain level of accumulation. At some point, when they are over the limit, their performance drops quickly resulting in damage to, or disposal of the stored products inside. The Self-Cleaning Condenser device keeps the condenser clean and prevents system failure by automatically brushing daily.

■ **Digital temperature control & monitor system**

Keeps food products safe by maintaining constant temperatures. External digital display allows for easy monitoring.

■ **Front Breathing airflow**

Front Breathing airflow is designed to draw in air and discharge from the front, allowing units to run at high efficiency in tight spaces and eliminates the need for surrounding clearances.

■ **Hydrocarbon refrigerants (R-290)**

With innovative and eco-friendly technology, Turbo Air brings you hydrocarbon refrigerators designed to meet DOE's Energy Conservation Standards in 2017 and to use EPA's SNAP Program approved HC refrigerants. Hydrocarbon refrigerants do not deplete the ozone layer and have very low contribution to global warming (ODP-0, GWP-3).

■ **Stainless steel cabinet construction**

The Turbo Air Super Deluxe model boasts a stainless steel interior (ABS door liner) and exterior (galvanized steel back & bottom) including durable stainless steel drawers. It guarantees the utmost in cleanliness and long product life. The Super Deluxe adds a touch of style to the most refined setting.

■ **Sturdy, clean stainless steel shelving**

Shelves are the most important part of cleanliness as they come in direct contact with food. After a while, PVC coated wire shelves may peel, rust and lead to unsanitary conditions. The Super Deluxe series uniquely provides stainless steel shelving (only TST-36SD-D2R(L)-FB-N, TST-48SD-D2R(L)-FB-N).

■ **9-1/2" deep, 1/2" thick high-density Polyethylene cutting board included with convenient side rail**

■ **Insulated pan cover**

■ **Ergonomically designed doors & drawers**

Customers' fatigue fades away with easy door grip and drawers that open effortlessly. These features along with self-closing doors make this the ultimate choice in customer convenience. ABS sheet door liners resist water condensation with thermal efficiency.



TST-28SD-D2-FB-N

TST-48SD-D2R-FB-N

Each drawer accommodates up to 6" deep sixth (1/6) size pans

Self-Cleaning Condenser
Maintenance-free during warranty period

■ **Refrigerator holds 33°F ~ 39°F for the best in food preservation**

■ **Standard features**

- Anti-corrosion coated evaporator
- Self-contained system
- 4" dia. swivel casters with locks on the front set
- 1/6 size, 4" deep condiment pans included (top of cabinet)

■ **Optional features**

- Stainless steel double overself available (only TST-48SD-D2R(L)-FB-N, TST-48SD-D4-FB-N)
- Stainless steel single overself available (except TST-28SD-D2-FB-N)
- Clear lids available
- Removable food covers available
- Legs available for all models: 6"
- Casters available for all models: 1" / 2.5" (except TST-28SD-D2-FB-N), 5"

TST MODELS SPECIFICATIONS

ELECTRICAL DATA	TST-28SD-D2-FB-N	TST-36SD-D2R(L)-FB-N	TST-36SD-D4-FB-N	TST-48SD-D2R(L)-FB-N	TST-48SD-D4-FB-N
Voltage	115/60/1	115/60/1	115/60/1	115/60/1	115/60/1
Plug Type	Ⓜ NEMA 5-15P	Ⓜ NEMA 5-15P	Ⓜ NEMA 5-15P	Ⓜ NEMA 5-15P	Ⓜ NEMA 5-15P
Full Load Amp.	6.6	3.8	3.8	6.5	6.5
Compressor HP	1/6	1/5	1/5	1/5	1/5
Cord Length (ft.)	10	10	10	10	10
Refrigerant	R-290	R-290	R-290	R-290	R-290
DIMENSIONAL DATA					
Net Capacity (cu. ft.)	6.5	8.46	8.46	11.1	11.1
Ext. Dimension (L x D x H [†]) (in.)	27 ^{1/2} x 30 x 37 ^{5/8}	36 ^{1/4} x 30 x 37	36 ^{1/4} x 30 x 37	48 ^{1/4} x 30 x 37 ^{5/8}	48 ^{1/4} x 30 x 37 ^{5/8}
# of Doors	-	1	-	1	-
# of Drawers	2	2	4	2	4
# of Shelves (Size (L x D) (in.))	-	1 (15 x 17)	-	1 (21 x 17)	-
# of Pans	8	12	12	12	12
Net Weight (lbs.)	187	157	157	243	253
Gross Weight (lbs.)	205	230	230	273	283

Design and specifications subject to change without notice. Most updated spec sheets are available at www.turboairinc.com.

Actual shipping weight may differ due to extra packing materials for product protection.

† Height does not include 4-1/2" for caster height.

■ **WARRANTY: 5 Year Parts and Labor Warranty, 7 Year Compressor Warranty**

SANDWICH/SALAD UNITS - FRONT BREATHING AIRFLOW/DRAWERS

Self-Cleaning Condenser Equipped Units

■ **Self-Cleaning Condenser (Patented)**

The accumulation of dust in the condenser can cause the failure or breakdown of refrigerators. Refrigerators run normally until they reach a certain level of accumulation. At some point, when they are over the limit, their performance drops quickly resulting in damage to, or disposal of the stored products inside. The Self-Cleaning Condenser device keeps the condenser clean and prevents system failure by automatically brushing daily.

■ **Digital temperature control & monitor system**

Keeps food products safe by maintaining constant temperatures. External digital display allows for easy monitoring.

■ **Front Breathing airflow**

Front Breathing airflow is designed to draw in air and discharge from the front, allowing units to run at high efficiency in tight spaces and eliminates the need for surrounding clearances.

■ **Hydrocarbon refrigerants (R-290)**

With innovative and eco-friendly technology, Turbo Air brings you hydrocarbon refrigerators designed to meet DOE's Energy Conservation Standards in 2017 and to use EPA's SNAP Program approved HC refrigerants. Hydrocarbon refrigerants do not deplete the ozone layer and have very low contribution to global warming (ODP-0, GWP-3).

■ **Stainless steel cabinet construction**

The Turbo Air Super Deluxe model boasts a stainless steel interior (ABS door liner) and exterior (galvanized steel back & bottom) including durable stainless steel drawers. It guarantees the utmost in cleanliness and long product life. The Super Deluxe adds a touch of style to the most refined setting.

■ **Sturdy, clean stainless steel shelving**

Shelves are the most important part of cleanliness as they come in direct contact with food. After a while, PVC coated wire shelves may peel, rust and lead to unsanitary conditions. The Super Deluxe series uniquely provides stainless steel shelving (only TST-60SD-D2R(L)-FB-N, TST-72SD-LD2R-FB-N, TST-72SD-D4R(L)-FB-N).

■ **9-1/2" deep, 1/2" thick high-density Polyethylene cutting board included with convenient side rail**

■ **Insulated pan cover**

■ **Ergonomically designed doors & drawers**

Customers' fatigue fades away with easy door grip and drawers that open effortlessly. These features along with self-closing doors make this the ultimate choice in customer convenience. ABS sheet door liners resist water condensation with thermal efficiency.



■ **Refrigerator holds 33°F ~ 39°F for the best in food preservation**

■ **Standard features**

- Anti-corrosion coated evaporator
- Self-contained system
- 4" dia. swivel casters with locks on the front set
- 1/6 size, 4" deep condiment pans included (top of cabinet)

■ **Optional features**

- Stainless steel single/double overshelf available
- Clear lids available
- Removable food covers available
- Legs available for all models: 6"
- Casters available for all models: 1", 2.5", 5"

TST MODELS SPECIFICATIONS

ELECTRICAL DATA	TST-60SD-D2R(L)-FB-N	TST-60SD-D4-FB-N	TST-72SD-D2LR-FB-N	TST-72SD-D4R(L)-FB-N	TST-72SD-D6-FB-N
Voltage	115/60/1	115/60/1	115/60/1	115/60/1	115/60/1
Plug Type	Ⓢ NEMA 5-15P	Ⓢ NEMA 5-15P	Ⓢ NEMA 5-15P	Ⓢ NEMA 5-15P	Ⓢ NEMA 5-15P
Full Load Amp.	8.9	8.9	9.9	9.9	9.9
Compressor HP	1/5	1/5	3/8	3/8	3/8
Cord Length (ft.)	10	10	10	10	10
Refrigerant	R-290	R-290	R-290	R-290	R-290
DIMENSIONAL DATA					
Net Capacity (cu. ft.)	14.8	14.8	20.5	17.6	17.6
Ext. Dimension (L x D x H†) (in.)	60 ^{1/4} x 30 x 37 ^{5/8}	60 ^{1/4} x 30 x 37 ^{5/8}	72 ^{5/8} x 30 x 37 ^{5/8}	72 ^{5/8} x 30 x 37 ^{5/8}	72 ^{5/8} x 30 x 37 ^{5/8}
# of Doors	1	-	2	1	-
# of Drawers	2	4	2	4	6
# of Shelves (Size (L x D) (in.))	1 (27 x 17)	-	2 (27 x 17)	1 (21 x 17)	-
# of Pans	16	16	18	18	18
Net Weight (lbs.)	284	294	352	344	354
Gross Weight (lbs.)	316	326	392	372	382

Design and specifications subject to change without notice. Most updated spec sheets are available at www.turboairinc.com.

Actual shipping weight may differ due to extra packing materials for product protection.

† Height does not include 4-1/2" for caster height.

■ **WARRANTY: 5 Year Parts and Labor Warranty, 7 Year Compressor Warranty**

MEGA TOP UNITS - FRONT BREATHING AIRFLOW/GLASS LID NATURAL Refrigerant

Self-Cleaning Condenser Equipped Units

■ **Self-Cleaning Condenser (Patented)**

The accumulation of dust in the condenser can cause the failure or breakdown of refrigerators. Refrigerators run normally until they reach a certain level of accumulation. At some point, when they are over the limit, their performance drops quickly resulting in damage to, or disposal of the stored products inside. The Self-Cleaning Condenser device keeps the condenser clean and prevents system failure by automatically brushing daily.

■ **Digital temperature control & monitor system**

Keeps food products safe by maintaining constant temperatures. External digital display allows for easy monitoring.

■ **Front Breathing airflow**

Front Breathing airflow is designed to draw in air and discharge from the front, allowing units to run at high efficiency in tight spaces and eliminates the need for surrounding clearances.

■ **Hydrocarbon refrigerants (R-290)**

With innovative and eco-friendly technology, Turbo Air brings you hydrocarbon refrigerators designed to meet DOE's Energy Conservation Standards in 2017 and to use EPA's SNAP Program approved HC refrigerants. Hydrocarbon refrigerants do not deplete the ozone layer and have very low contribution to global warming (ODP-0, GWP-3).

■ **Stainless steel cabinet construction**

The Turbo Air Super Deluxe model boasts a stainless steel interior (ABS door liner) and exterior (galvanized steel back & bottom). It guarantees the utmost in cleanliness and long product life. The Super Deluxe adds a touch of style to the most refined setting.

■ **Sturdy, clean stainless steel shelving**

Shelves are the most important part of cleanliness as they come in direct contact with food. After a while, PVC coated wire shelves may peel, rust and lead to unsanitary conditions. The Super Deluxe series uniquely provides stainless steel shelving.

■ **6-1/4" deep, 1/2" thick high-density Polyethylene cutting board included with convenient side rail**

■ **Refrigerator holds 33°F ~ 39°F for the best in food preservation**



TST-48SD-18-FB-N-GL

TST-60SD-24-FB-N-GL

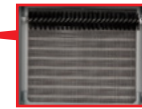

Self-Cleaning Condenser
Maintenance-free during warranty period

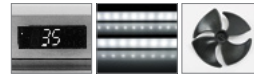

LED interior lighting & fan control

Energy efficient LED lighting lights every corner, making items easy to find. Fan control function automatically shuts off the fan when the door is open, which prevents hot air from being drawn in, thus maintaining the cool inner temperature.

■ **Standard features**

- Anti-corrosion coated evaporator
- Self-contained system
- 4" dia. swivel casters with locks on the front set
- 1/6 size, 4" deep condiment pans included
- High-density polyurethane insulation

■ **Optional features**

- Legs available for all models: 6"
- Door locks available (extra lead time will apply)
- Casters available for all models: 1", 2.5", 5"

TST MODELS SPECIFICATIONS

ELECTRICAL DATA	TST-48SD-18-FB-N-GL	TST-60SD-24-FB-N-GL	TST-72SD-30-FB-N-GL
Voltage	115/60/1	115/60/1	115/60/1
Plug Type	Ⓜ NEMA 5-15P	Ⓜ NEMA 5-15P	Ⓜ NEMA 5-15P
Full Load Amp.	6.5	8.9	9.9
Compressor HP	1/5	1/5	3/8
Cord Length (ft.)	10	10	10
Refrigerant	R-290	R-290	R-290
DIMENSIONAL DATA			
Net Capacity (cu. ft.)	11.1	14.8	17.6
Ext. Dimension (L x D [†] x H [†]) (in.)	48 1/4 x 34 5/8 x 32 5/8	60 1/4 x 34 5/8 x 32 5/8	72 5/8 x 34 5/8 x 32 5/8
# of Doors	2	2	3
# of Shelves (Size (L x D) (in.))	2 (21 x 17)	2 (27 x 17)	3 (21 x 17 (L/R), 23 x 17 (M))
# of Pans	18	24	30
Net Weight (lbs.)	244	321	356
Gross Weight (lbs.)	264	352	396

Design and specifications subject to change without notice. Most updated spec sheets are available at www.turboairinc.com.

Actual shipping weight may differ due to extra packing materials for product protection.

* Depth does not include 1" for cutting boards. † Height does not include 4-1/2" for caster height.

■ **WARRANTY: 5 Year Parts and Labor Warranty, 7 Year Compressor Warranty**

MEGA TOP UNITS - FRONT BREATHING AIRFLOW NATURAL Refrigerant

Self-Cleaning Condenser Equipped Units

Self-Cleaning Condenser (Patented)

The accumulation of dust in the condenser can cause the failure or breakdown of refrigerators. Refrigerators run normally until they reach a certain level of accumulation. At some point, when they are over the limit, their performance drops quickly resulting in damage to, or disposal of the stored products inside. The Self-Cleaning Condenser device keeps the condenser clean and prevents system failure by automatically brushing daily.

Digital temperature control & monitor system

Keeps food products safe by maintaining constant temperatures. External digital display allows for easy monitoring.

Front Breathing airflow

Front Breathing airflow is designed to draw in air and discharge from the front, allowing units to run at high efficiency in tight spaces and eliminates the need for surrounding clearances.

Hydrocarbon refrigerants (R-290)

With innovative and eco-friendly technology, Turbo Air brings you hydrocarbon refrigerators designed to meet DOE's Energy Conservation Standards in 2017 and to use EPA's SNAP Program approved HC refrigerants. Hydrocarbon refrigerants do not deplete the ozone layer and have very low contribution to global warming (ODP-0, GWP-3).

Stainless steel cabinet construction

The Turbo Air Super Deluxe model boasts a stainless steel interior (ABS door liner) and exterior (galvanized steel back & bottom). It guarantees the utmost in cleanliness and long product life. The Super Deluxe adds a touch of style to the most refined setting.

Sturdy, clean stainless steel shelving

Shelves are the most important part of cleanliness as they come in direct contact with food. After a while, PVC coated wire shelves may peel, rust and lead to unsanitary conditions. The Super Deluxe series uniquely provides stainless steel shelving.

9-1/2" deep, 1/2" thick high-density Polyethylene cutting board included with convenient side rail

Insulated pan cover

Refrigerator holds 33°F ~ 39°F for the best in food preservation



TST-48SD-18-FB-N

TST-72SD-30-FB-N



Self-Cleaning Condenser
Maintenance-free during warranty period

LED interior lighting & fan control

Energy efficient LED lighting lights every corner, making items easy to find. Fan control function automatically shuts off the fan when the door is open, which prevents hot air from being drawn in, thus maintaining the cool inner temperature.

Standard features

- Anti-corrosion coated evaporator
- Self-contained system
- 4" dia. swivel casters with locks on the front set
- 1/6 size, 4" deep condiment pans included
- High-density polyurethane insulation

Optional features

- Stainless steel single overshelf available (except TST-28SD-12-FB-N, TST-36SD-15-FB-N)
- Stainless steel double overshelf available (except TST-28SD-12-FB-N)
- Clear lids available
- Removable food covers available
- Legs available for all models: 6"
- Door locks available (extra lead time will apply)
- Casters available for all models: 1" / 2.5" (except TST-28SD-12-FB-N), 5"

TST MODELS SPECIFICATIONS

ELECTRICAL DATA	TST-28SD-12-FB-N	TST-36SD-15-FB-N	TST-48SD-18-FB-N	TST-60SD-24-FB-N	TST-72SD-30-FB-N
Voltage	115/60/1	115/60/1	115/60/1	115/60/1	115/60/1
Plug Type	Ⓜ NEMA 5-15P	Ⓜ NEMA 5-15P	Ⓜ NEMA 5-15P	Ⓜ NEMA 5-15P	Ⓜ NEMA 5-15P
Full Load Amp.	3.8	3.8	4.4	4.4	5.7
Compressor HP	1/5	1/5	1/3	1/3	2/5
Cord Length (ft.)	10	10	10	10	10
Refrigerant	R-290	R-290	R-290	R-290	R-290
DIMENSIONAL DATA					
Net Capacity (cu. ft.)	7.4	8.8	13.9	17.6	21.3
Ext. Dimension (L x D* x H†) (in.)	27 1/2 x 34 x 39 5/8	36 1/4 x 34 x 39 5/8	48 1/4 x 34 x 39 5/8	60 1/4 x 34 x 39 5/8	72 5/8 x 34 x 39 5/8
# of Doors	1	2	2	2	3
# of Shelves (Size (L x D) (in.))	1 (22 1/2 x 17)	2 (15 x 17)	2 (21 x 17)	2 (27 x 17)	3 (21 x 17 (L/R), 23 x 17 (M))
# of Pans	12	15	18	24	30
Net Weight (lbs.)	206	226	244	321	356
Gross Weight (lbs.)	220	242	264	352	396

Design and specifications subject to change without notice. Most updated spec sheets are available at www.turboairinc.com.

Actual shipping weight may differ due to extra packing materials for product protection.

* Depth does not include 3" for cutting boards. † Height does not include 4-1/2" for caster height.

WARRANTY: 5 Year Parts and Labor Warranty, 7 Year Compressor Warranty

MEGA TOP UNITS - FRONT BREATHING AIRFLOW/DRAWERS NATURAL Refrigerant

Self-Cleaning Condenser Equipped Units

■ **Self-Cleaning Condenser (Patented)**

The accumulation of dust in the condenser can cause the failure or breakdown of refrigerators. Refrigerators run normally until they reach a certain level of accumulation. At some point, when they are over the limit, their performance drops quickly resulting in damage to, or disposal of the stored products inside. The Self-Cleaning Condenser device keeps the condenser clean and prevents system failure by automatically brushing daily.

■ **Digital temperature control & monitor system**

Keeps food products safe by maintaining constant temperatures. External digital display allows for easy monitoring.

■ **Front Breathing airflow**

Front Breathing airflow is designed to draw in air and discharge from the front, allowing units to run at high efficiency in tight spaces and eliminates the need for surrounding clearances.

■ **Hydrocarbon refrigerants (R-290)**

With innovative and eco-friendly technology, Turbo Air brings you hydrocarbon refrigerators designed to meet DOE's Energy Conservation Standards in 2017 and to use EPA's SNAP Program approved HC refrigerants. Hydrocarbon refrigerants do not deplete the ozone layer and have very low contribution to global warming (ODP-0, GWP-3).

■ **Stainless steel cabinet construction**

The Turbo Air Super Deluxe model boasts a stainless steel interior (ABS door liner) and exterior (galvanized steel back & bottom) including durable stainless steel drawers. It guarantees the utmost in cleanliness and long product life. The Super Deluxe adds a touch of style to the most refined setting.

■ **Sturdy, clean stainless steel shelving**

Shelves are the most important part of cleanliness as they come in direct contact with food. After a while, PVC coated wire shelves may peel, rust and lead to unsanitary conditions. The Super Deluxe series uniquely provides stainless steel shelving (only TST-48SD-18-D2R(L)-FB-N, TST-60SD-24-D2R(L)-FB-N).

■ **9-1/2" deep, 1/2" thick high-density Polyethylene cutting board included with convenient side rail**

■ **Ergonomically designed doors & drawers**

Customers' fatigue fades away with easy door grip and drawers that open effortlessly. These features along with self-closing doors make this the ultimate choice in customer convenience. ABS sheet door liners resist water condensation with thermal efficiency.



TST-28SD-12-D2-FB-N

TST-60SD-24-D2L-FB-N

Each drawer accommodates up to 6" deep sixth (1/6) size pans

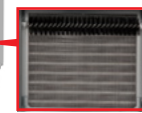

Self-Cleaning Condenser Maintenance-free during warranty period

■ **Insulated pan cover**

■ **Refrigerator holds 33°F ~ 39°F for the best in food preservation**

■ **Standard features**

- Anti-corrosion coated evaporator
- Self-contained system
- 4" dia. swivel casters with locks on the front set
- 1/6 size, 4" deep condiment pans included (top of cabinet)
- Lead time applies

■ **Optional features**

- Stainless steel single/double overs shelf available (except TST-28SD-12-D2-FB-N)
- Clear lids available
- Removable food covers available
- Legs available for all models: 6"
- Casters available for all models: 1" / 2.5" (except TST-28SD-12-D2-FB-N), 5"

TST MODELS SPECIFICATIONS

ELECTRICAL DATA	TST-28SD-12-D2-FB-N	TST-48SD-18-D2R(L)-FB-N	TST-48SD-18-D4-FB-N	TST-60SD-24-D2R(L)-FB-N
Voltage	115/60/1	115/60/1	115/60/1	115/60/1
Plug Type	Ⓜ NEMA 5-15P	Ⓜ NEMA 5-15P	Ⓜ NEMA 5-15P	Ⓜ NEMA 5-15P
Full Load Amp.	6.6	6.5	6.5	8.9
Compressor HP	1/5	1/5	1/5	1/5
Cord Length (ft.)	10	10	10	10
Refrigerant	R-290	R-290	R-290	R-290
DIMENSIONAL DATA				
Net Capacity (cu. ft.)	6.5	11.1	11.1	14.8
Ext. Dimension (L x D x H†) (in.)	27 1/2 x 34 x 39 5/8	48 1/4 x 34 x 39 5/8	48 1/4 x 34 x 39 5/8	60 1/4 x 34 x 39 5/8
# of Doors	-	1	-	1
# of Drawers	2	2	4	2
# of Shelves (Size (L x D) (in.))	-	1 (21 x 17)	-	1 (27 x 17)
# of Pans	12	18	18	24
Net Weight (lbs.)	206	244	254	321
Gross Weight (lbs.)	220	264	274	352

Design and specifications subject to change without notice. Most updated spec sheets are available at www.turboairinc.com.

Actual shipping weight may differ due to extra packing materials for product protection.

* Depth does not include 3" for cutting boards. † Height does not include 4-1/2" for caster height.

■ **WARRANTY: 5 Year Parts and Labor Warranty, 7 Year Compressor Warranty**

MEGA TOP UNITS - FRONT BREATHING AIRFLOW/DRAWERS NATURAL Refrigerant

Self-Cleaning Condenser Equipped Units

■ **Self-Cleaning Condenser (Patented)**

The accumulation of dust in the condenser can cause the failure or breakdown of refrigerators. Refrigerators run normally until they reach a certain level of accumulation. At some point, when they are over the limit, their performance drops quickly resulting in damage to, or disposal of the stored products inside. The Self-Cleaning Condenser device keeps the condenser clean and prevents system failure by automatically brushing daily.

■ **Digital temperature control & monitor system**

Keeps food products safe by maintaining constant temperatures. External digital display allows for easy monitoring.

■ **Front Breathing airflow**

Front Breathing airflow is designed to draw in air and discharge from the front, allowing units to run at high efficiency in tight spaces and eliminates the need for surrounding clearances.

■ **Hydrocarbon refrigerants (R-290)**

With innovative and eco-friendly technology, Turbo Air brings you hydrocarbon refrigerators designed to meet DOE's Energy Conservation Standards in 2017 and to use EPA's SNAP Program approved HC refrigerants. Hydrocarbon refrigerants do not deplete the ozone layer and have very low contribution to global warming (ODP-0, GWP-3).

■ **Stainless steel cabinet construction**

The Turbo Air Super Deluxe model boasts a stainless steel interior (ABS door liner) and exterior (galvanized steel back & bottom) including durable stainless steel drawers. It guarantees the utmost in cleanliness and long product life. The Super Deluxe adds a touch of style to the most refined setting.

■ **Sturdy, clean stainless steel shelving**

Shelves are the most important part of cleanliness as they come in direct contact with food. After a while, PVC coated wire shelves may peel, rust and lead to unsanitary conditions. The Super Deluxe series uniquely provides stainless steel shelving (only TST-72SD-30-LD2R-FB-N, TST-72SD-30-D4R(L)-FB-N).

■ **9-1/2" deep, 1/2" thick high-density Polyethylene cutting board included with convenient side rail**

■ **Ergonomically designed doors & drawers**

Customers' fatigue fades away with easy door grip and drawers that open effortlessly. These features along with self-closing doors make this the ultimate choice in customer convenience. ABS sheet door liners resist water condensation with thermal efficiency.



■ **Insulated pan cover**

■ **Refrigerator holds 33°F ~ 39°F for the best in food preservation**

■ **Standard features**

- Anti-corrosion coated evaporator
- Self-contained system
- 4" dia. swivel casters with locks on the front set
- 1/6 size, 4" deep condiment pans included (top of cabinet)
- Lead time applies

■ **Optional features**

- Stainless steel single/double overself available
- Clear lids available
- Removable food covers available
- Legs available for all models: 6"
- Casters available for all models: 1", 2.5", 5"

TST MODELS SPECIFICATIONS

ELECTRICAL DATA	TST-60SD-24-D4-FB-N	TST-72SD-30-LD2R-FB-N	TST-72SD-30-D4R(L)-FB-N	TST-72SD-30-D6-FB-N
Voltage	115/60/1	115/60/1	115/60/1	115/60/1
Plug Type	Ⓢ NEMA 5-15P	Ⓢ NEMA 5-15P	Ⓢ NEMA 5-15P	Ⓢ NEMA 5-15P
Full Load Amp.	8.9	9.9	9.9	9.9
Compressor HP	1/5	3/8	3/8	3/8
Cord Length (ft.)	10	10	10	10
Refrigerant	R-290	R-290	R-290	R-290
DIMENSIONAL DATA				
Net Capacity (cu. ft.)	14.8	20.5	17.6	17.6
Ext. Dimension (L x D [*] x H [†]) (in.)	60 ^{1/4} x 34 x 39 ^{5/8}	72 ^{5/8} x 34 x 39 ^{5/8}	72 ^{5/8} x 34 x 39 ^{5/8}	72 ^{5/8} x 34 x 39 ^{5/8}
# of Doors	-	2	1	-
# of Drawers	4	2	4	6
# of Shelves (Size (L x D) (in.))	-	2 (21 x 17 (L/R))	1 (21 x 17)	-
# of Pans	24	30	30	30
Net Weight (lbs.)	331	352	356	366
Gross Weight (lbs.)	362	392	396	406

Design and specifications subject to change without notice. Most updated spec sheets are available at www.turboairinc.com.

Actual shipping weight may differ due to extra packing materials for product protection.

* Depth does not include 3" for cutting boards. † Height does not include 4-1/2" for caster height.

■ **WARRANTY: 5 Year Parts and Labor Warranty, 7 Year Compressor Warranty**

MEGA TOP UNITS - DRAWERS/FRONT BREATHING AIRFLOW/SLIDE BACK LID

Self-Cleaning Condenser Equipped Units

■ **Self-Cleaning Condenser (Patented)**

The accumulation of dust in the condenser can cause the failure or breakdown of refrigerators. Refrigerators run normally until they reach a certain level of accumulation. At some point, when they are over the limit, their performance drops quickly resulting in damage to, or disposal of the stored products inside. The Self-Cleaning Condenser device keeps the condenser clean and prevents system failure by automatically brushing daily.

■ **Digital temperature control & monitor system**

Keeps food products safe by maintaining constant temperatures. External digital display allows for easy monitoring.

■ **Front Breathing airflow**

Front Breathing airflow is designed to draw in air and discharge from the front, allowing units to run at high efficiency in tight spaces and eliminates the need for surrounding clearances.

■ **Hydrocarbon refrigerants (R-290)**

With innovative and eco-friendly technology, Turbo Air brings you hydrocarbon refrigerators designed to meet DOE's Energy Conservation Standards in 2017 and to use EPA's SNAP Program approved HC refrigerants. Hydrocarbon refrigerants do not deplete the ozone layer and have very low contribution to global warming (ODP-0, GWP-3).

■ **Stainless steel cabinet construction**

The Turbo Air Super Deluxe model boasts a stainless steel interior (ABS door liner) and exterior (galvanized steel back & bottom) including durable stainless steel drawers. It guarantees the utmost in cleanliness and long product life. The Super Deluxe adds a touch of style to the most refined setting.

■ **Cold Bunker System**

Our innovative forced air system allows cold air to flow all around the food pan area, covering not only underneath the pan, but also the front, top and the rear. This unique air flow creates a cold air-shield around the pan, which maintains the food temperature at under 41°F (NSF requirement) even when the lids are opened. In addition, the compartment isolates pans from the reach-in area to prevent food spillage.

■ **9-1/2" deep, 1/2" thick high-density Polyethylene cutting board included with convenient side rail**

■ **High-density polyurethane insulation**

The entire cabinet structure and solid doors are foamed-in-place high density, CFC free polyurethane insulation.

■ **Insulated pan cover**



TST-72SD-30-LRD2-FB-N-SL

Each drawer accommodates up to 6" deep sixth (1/6) size pans

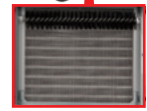

Self-Cleaning Condenser
Maintenance-free during warranty period

■ **Refrigerator holds 33°F ~ 39°F for the best in food preservation**

■ **Standard features**

- Anti-corrosion coated evaporator
- Self-contained system
- 4" dia. swivel casters with locks on the front set
- 1/6 size, 4" deep condiment pans included (top of cabinet)

■ **Optional features**

- Stainless steel single/double overshef available
- Clear lids available
- Removable food covers available
- Legs available for all models: 6"
- Casters available for all models: 1", 2.5", 5"
- Additional stainless steel shelf

TST MODELS SPECIFICATIONS

ELECTRICAL DATA		TST-72SD-30-LRD2-FB-N-SL
Voltage		115/60/1
Plug Type		Ⓜ NEMA 5-15P
Full Load Amp.		9.9
Compressor HP		3/8
Cord Length (ft.)		10
Refrigerant		R-290
DIMENSIONAL DATA		
Net Capacity (cu. ft.)		20.5
Ext. Dimension (L x D x H†) (in.)		72 5/8 x 34 x 39 5/8
# of Doors		2
# of Drawers		2
# of Shelves (Size (L x D) (in.))		2 (21 x 17(L), 23 X 17(M))
# of Pans		30
Net Weight (lbs.)		356
Gross Weight (lbs.)		396

Design and specifications subject to change without notice. Most updated spec sheets are available at www.turboairinc.com.

Actual shipping weight may differ due to extra packing materials for product protection.

* Depth does not include 3" for cutting boards. † Height does not include 4-1/2" for caster height.

■ **WARRANTY: 5 Year Parts and Labor Warranty, 7 Year Compressor Warranty**

SANDWICH/SALAD UNITS - FRONT BREATHING AIRFLOW

Self-Cleaning Condenser Equipped Units

Self-Cleaning Condenser (Patented)

The accumulation of dust in the condenser can cause the failure or breakdown of refrigerators. Refrigerators run normally until they reach a certain level of accumulation. At some point, when they are over the limit, their performance drops quickly resulting in damage to, or disposal of the stored products inside. The Self-Cleaning Condenser device keeps the condenser clean and prevents system failure by automatically brushing daily.

Digital temperature control & monitor system

Keeps food products safe by maintaining constant temperatures. External digital display allows for easy monitoring.

Front Breathing airflow

Front Breathing airflow is designed to draw in air and discharge from the front, allowing units to run at high efficiency in tight spaces and eliminates the need for surrounding clearances.

Hydrocarbon refrigerants (R-290)

With innovative and eco-friendly technology, Turbo Air brings you hydrocarbon refrigerators designed to meet DOE's Energy Conservation Standards in 2017 and to use EPA's SNAP Program approved HC refrigerants. Hydrocarbon refrigerants do not deplete the ozone layer and have very low contribution to global warming (ODP-0, GWP-3).

Stainless steel cabinet construction

The Turbo Air Super Deluxe model boasts a stainless steel interior (ABS door liner) and exterior (galvanized steel back & bottom). It guarantees the utmost in cleanliness and long product life. The Super Deluxe adds a touch of style to the most refined setting.

Sturdy, clean stainless steel shelving

Shelves are the most important part of cleanliness as they come in direct contact with food. After a while, PVC coated wire shelves may peel, rust and lead to unsanitary conditions. The Super Deluxe series uniquely provides stainless steel shelving.

High-density polyurethane insulation

The entire cabinet structure and solid doors are foamed-in-place high density, CFC free polyurethane insulation.

9-1/2" deep, 1/2" thick high-density Polyethylene cutting board included with convenient side rail

Insulated pan cover

Refrigerator holds 33°F ~ 39°F for the best in food preservation



TST-48SD-08S-FB-N

TST-72SD-10S-N-FB-LW

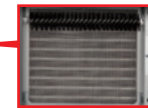

Self-Cleaning Condenser
Maintenance-free during warranty period

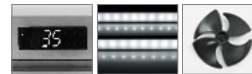

LED interior lighting & fan control

Energy efficient LED lighting lights every corner, making items easy to find. Fan control function automatically shuts off the fan when the door is open, which prevents hot air from being drawn in, thus maintaining the cool inner temperature.

Standard features

- Anti-corrosion coated evaporator
- Self-contained system
- 4" dia. swivel casters with locks on the front set
- 1/6 size, 4" deep condiment pans included
- Lead time applies

Optional features

- Stainless steel single/double overshelf available
- Removable food covers available
- Legs available for all models: 6"
- Door locks available (extra lead time will apply)
- Casters available for all models: 1", 2.5", 5"

TST MODELS SPECIFICATIONS

ELECTRICAL DATA	TST-48SD-08S-FB-N(-LW)	TST-60SD-08S-FB-N(-LW)	TST-72SD-08S-FB-N(-LW)	TST-72SD-10S-FB-N(-LW)	TST-72SD-12S-FB-N(-LW)
Voltage	115/60/1	115/60/1	115/60/1	115/60/1	115/60/1
Plug Type	Ⓜ NEMA 5-15P	Ⓜ NEMA 5-15P	Ⓜ NEMA 5-15P	Ⓜ NEMA 5-15P	Ⓜ NEMA 5-15P
Full Load Amp.	4.4	4.4	5.7	5.7	9.9
Compressor HP	1/3	1/3	2/5	2/5	3/8
Cord Length (ft.)	9	9	9	9	9
Refrigerant	R-290	R-290	R-290	R-290	R-290
DIMENSIONAL DATA					
Net Capacity (cu. ft.)	11.1	14.8	17.6	17.6	20.5
Ext. Dimension (L x D x H†) (in.)	48 ¹ / ₄ x 30 x 42 ¹ / ₈	60 ¹ / ₄ x 30 x 42 ¹ / ₈	72 ⁵ / ₈ x 30 x 42 ¹ / ₈	72 ⁵ / ₈ x 30 x 42 ¹ / ₈	72 ⁵ / ₈ x 30 x 42 ¹ / ₈
# of Doors	2	2	3	3	3
# of Shelves (Size (L x D) (in.))	2 (21 x 17)	2 (27 x 17)	3 (21 x 17 (L/R), 23 x 17 (M))	3 (21 x 17 (L/R), 23 x 17 (M))	3 (21 x 17 (L/R), 23 x 17 (M))
# of Pans	8	8	8	10	12
Net Weight (lbs.)	243	284	344	344	344
Gross Weight (lbs.)	273	316	372	372	372

Design and specifications subject to change without notice. Most updated spec sheets are available at www.turboairinc.com.

Actual shipping weight may differ due to extra packing materials for product protection.

† Height does not include 4-1/2" for caster height.

WARRANTY: 5 Year Parts and Labor Warranty, 7 Year Compressor Warranty

SANDWICH/SALAD UNITS - FRONT BREATHING AIRFLOW/DRAWERS

Self-Cleaning Condenser Equipped Units

Self-Cleaning Condenser (Patented)

The accumulation of dust in the condenser can cause the failure or breakdown of refrigerators. Refrigerators run normally until they reach a certain level of accumulation. At some point, when they are over the limit, their performance drops quickly resulting in damage to, or disposal of the stored products inside. The Self-Cleaning Condenser device keeps the condenser clean and prevents system failure by automatically brushing daily.

Digital temperature control & monitor system

Keeps food products safe by maintaining constant temperatures. External digital display allows for easy monitoring.

Front Breathing airflow

Front Breathing airflow is designed to draw in air and discharge from the front, allowing units to run at high efficiency in tight spaces and eliminates the need for surrounding clearances.

Hydrocarbon refrigerants (R-290)

With innovative and eco-friendly technology, Turbo Air brings you hydrocarbon refrigerators designed to meet DOE's Energy Conservation Standards in 2017 and to use EPA's SNAP Program approved HC refrigerants. Hydrocarbon refrigerants do not deplete the ozone layer and have very low contribution to global warming (ODP-0, GWP-3).

Stainless steel cabinet construction

The Turbo Air Super Deluxe model boasts a stainless steel interior (ABS door liner) and exterior (galvanized steel back & bottom). It guarantees the utmost in cleanliness and long product life. The Super Deluxe adds a touch of style to the most refined setting.

Sturdy, clean stainless steel shelving

Shelves are the most important part of cleanliness as they come in direct contact with food. After a while, PVC coated wire shelves may peel, rust and lead to unsanitary conditions. The Super Deluxe series uniquely provides stainless steel shelving (only TST-48SD-08S-D2R(L)-FB-N, TST-60SD-08S-D2R(L)-FB-N).

High-density polyurethane insulation

The entire cabinet structure and solid doors are foamed-in-place high density, CFC free polyurethane insulation.

9-1/2" deep, 1/2" thick high-density Polyethylene cutting board included with convenient side rail

Insulated pan cover



TST-60SD-08S-D2L-FB-N

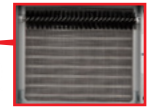

Self-Cleaning Condenser
Maintenance-free during warranty period

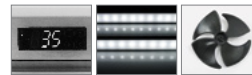

LED interior lighting & fan control

Energy efficient LED lighting lights every corner, making items easy to find. Fan control function automatically shuts off the fan when the door is open, which prevents hot air from being drawn in, thus maintaining the cool inner temperature (only TST-48SD-08S-D2R(L)-FB-N, TST-60SD-08S-D2R(L)-FB-N).

Refrigerator holds 33°F ~ 39°F for the best in food preservation

Standard features

- Anti-corrosion coated evaporator
- Self-contained system
- 4" dia. swivel casters with locks on the front set
- 1/6 size, 4" deep condiment pans included
- Lead time applies

Optional features

- Stainless steel single/double overself available
- Removable food covers available
- Legs available for all models: 6"
- Door locks available (extra lead time will apply)
- Casters available for all models: 1", 2.5", 5"

TST MODELS SPECIFICATIONS

ELECTRICAL DATA	TST-48SD-08S-D2R-FB-N(-LW) TST-48SD-08S-D2L-FB-N(-LW)	TST-48SD-08S-D4-FB-N(-LW)	TST-60SD-08S-D2R-FB-N(-LW) TST-60SD-08S-D2L-FB-N(-LW)	TST-60SD-08S-D4-FB-N(-LW)
Voltage	115/60/1	115/60/1	115/60/1	115/60/1
Plug Type	Ⓢ NEMA 5-15P	Ⓢ NEMA 5-15P	Ⓢ NEMA 5-15P	Ⓢ NEMA 5-15P
Full Load Amp.	4.4	4.4	4.4	4.4
Compressor HP	1/3	1/3	1/3	1/3
Cord Length (ft.)	9	9	9	9
Refrigerant	R-290	R-290	R-290	R-290
DIMENSIONAL DATA				
Net Capacity (cu. ft.)	11.1	11.1	14.8	14.8
Ext. Dimension (L x D x H†) (in.)	48 1/4 x 30 x 42 1/8	48 1/4 x 30 x 42 1/8	60 1/4 x 30 x 42 1/8	60 1/4 x 30 x 42 1/8
# of Doors	1	-	1	-
# of Drawers	2	4	2	4
# of Shelves (Size (L x D) (in.))	1 (21 x 17)	-	27 x 17	-
# of Pans	8	8	8	12
Net Weight (lbs.)	243	243	284	284
Gross Weight (lbs.)	273	273	316	316

Design and specifications subject to change without notice. Most updated spec sheets are available at www.turboairinc.com.

Actual shipping weight may differ due to extra packing materials for product protection.

† Height does not include 4-1/2" for caster height.

WARRANTY: 5 Year Parts and Labor Warranty, 7 Year Compressor Warranty

SANDWICH/SALAD UNITS - FRONT BREATHING AIRFLOW/DRAWERS

Self-Cleaning Condenser Equipped Units

■ **Self-Cleaning Condenser (Patented)**

The accumulation of dust in the condenser can cause the failure or breakdown of refrigerators. Refrigerators run normally until they reach a certain level of accumulation. At some point, when they are over the limit, their performance drops quickly resulting in damage to, or disposal of the stored products inside. The Self-Cleaning Condenser device keeps the condenser clean and prevents system failure by automatically brushing daily.

■ **Digital temperature control & monitor system**

Keeps food products safe by maintaining constant temperatures. External digital display allows for easy monitoring.

■ **Front Breathing airflow**

Front Breathing airflow is designed to draw in air and discharge from the front, allowing units to run at high efficiency in tight spaces and eliminates the need for surrounding clearances.

■ **Hydrocarbon refrigerants (R-290)**

With innovative and eco-friendly technology, Turbo Air brings you hydrocarbon refrigerators designed to meet DOE's Energy Conservation Standards in 2017 and to use EPA's SNAP Program approved HC refrigerants. Hydrocarbon refrigerants do not deplete the ozone layer and have very low contribution to global warming (ODP-0, GWP-3).

■ **Stainless steel cabinet construction**

The Turbo Air Super Deluxe model boasts a stainless steel interior (ABS door liner) and exterior (galvanized steel back & bottom). It guarantees the utmost in cleanliness and long product life. The Super Deluxe adds a touch of style to the most refined setting.

■ **Sturdy, clean stainless steel shelving**

Shelves are the most important part of cleanliness as they come in direct contact with food. After a while, PVC coated wire shelves may peel, rust and lead to unsanitary conditions. The Super Deluxe series uniquely provides stainless steel shelving (except TST-72SD-08S-D6-FB-N).

■ **High-density polyurethane insulation**

The entire cabinet structure and solid doors are foamed-in-place high density, CFC free polyurethane insulation.

■ **9-1/2" deep, 1/2" thick high-density Polyethylene cutting board included with convenient side rail**

■ **Insulated pan cover**

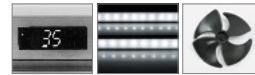

LED interior lighting & fan control

Energy efficient LED lighting lights every corner, making items easy to find. Fan control function automatically shuts off the fan when the door is open, which prevents hot air from being drawn in, thus maintaining the cool inner temperature (except TST-72SD-08S-D6-FB-N).

■ **Refrigerator holds 33°F ~ 39°F for the best in food preservation**

■ **Standard features**

- Anti-corrosion coated evaporator
- Self-contained system
- 4" dia. swivel casters with locks on the front set
- 1/6 size, 4" deep condiment pans included
- Lead time applies

■ **Optional features**

- Stainless steel single/double overself available
- Removable food covers available
- Legs available for all models: 6"
- Door locks available (extra lead time will apply)
- Casters available for all models: 1", 2.5", 5"

TST MODELS SPECIFICATIONS

ELECTRICAL DATA	TST-72SD-08S-D2LR-FB-N(-LW)	TST-72SD-08S-D4R-FB-N(-LW) TST-72SD-08S-D4L-FB-N(-LW)	TST-72SD-08S-D6-FB-N(-LW)	TST-72SD-10S-D2LR-FB-N(-LW)
Voltage	115/60/1	115/60/1	115/60/1	115/60/1
Plug Type	Ⓜ NEMA 5-15P	Ⓜ NEMA 5-15P	Ⓜ NEMA 5-15P	Ⓜ NEMA 5-15P
Full Load Amp.	5.7	5.7	5.7	5.7
Compressor HP	2/5	2/5	2/5	2/5
Cord Length (ft.)	9	9	9	9
Refrigerant	R-290	R-290	R-290	R-290
DIMENSIONAL DATA				
Net Capacity (cu. ft.)	17.6	17.6	17.6	17.6
Ext. Dimension (L x D x H†) (in.)	72 ⁵ / ₈ x 30 x 42 ¹ / ₈	72 ⁵ / ₈ x 30 x 42 ¹ / ₈	72 ⁵ / ₈ x 30 x 42 ¹ / ₈	72 ⁵ / ₈ x 30 x 42 ¹ / ₈
# of Doors	2	1	-	2
# of Drawers	2	4	6	2
# of Shelves (Size (L x D) (in.))	2 (21 x 17)	1 (21 x 17)	0	2 (21 x 17 (L/R))
# of Pans	8	8	8	10
Net Weight (lbs.)	344	344	344	344
Gross Weight (lbs.)	372	372	372	372

Design and specifications subject to change without notice. Most updated spec sheets are available at www.turboairinc.com.

Actual shipping weight may differ due to extra packing materials for product protection.

† Height does not include 4-1/2" for caster height.

■ **WARRANTY: 5 Year Parts and Labor Warranty, 7 Year Compressor Warranty**

SANDWICH/SALAD UNITS - FRONT BREATHING AIRFLOW/DRAWERS

Self-Cleaning Condenser Equipped Units

■ **Self-Cleaning Condenser (Patented)**

The accumulation of dust in the condenser can cause the failure or breakdown of refrigerators. Refrigerators run normally until they reach a certain level of accumulation. At some point, when they are over the limit, their performance drops quickly resulting in damage to, or disposal of the stored products inside. The Self-Cleaning Condenser device keeps the condenser clean and prevents system failure by automatically brushing daily.

■ **Digital temperature control & monitor system**

Keeps food products safe by maintaining constant temperatures. External digital display allows for easy monitoring.

■ **Front Breathing airflow**

Front Breathing airflow is designed to draw in air and discharge from the front, allowing units to run at high efficiency in tight spaces and eliminates the need for surrounding clearances.

■ **Hydrocarbon refrigerants (R-290)**

With innovative and eco-friendly technology, Turbo Air brings you hydrocarbon refrigerators designed to meet DOE's Energy Conservation Standards in 2017 and to use EPA's SNAP Program approved HC refrigerants. Hydrocarbon refrigerants do not deplete the ozone layer and have very low contribution to global warming (ODP-0, GWP-3).

■ **Stainless steel cabinet construction**

The Turbo Air Super Deluxe model boasts a stainless steel interior (ABS door liner) and exterior (galvanized steel back & bottom). It guarantees the utmost in cleanliness and long product life. The Super Deluxe adds a touch of style to the most refined setting.

■ **Sturdy, clean stainless steel shelving**

Shelves are the most important part of cleanliness as they come in direct contact with food. After a while, PVC coated wire shelves may peel, rust and lead to unsanitary conditions. The Super Deluxe series uniquely provides stainless steel shelving (only TST-72SD-10S-D4R(L)-FB-N, TST-72SD-12S-LD2R-FB-N, TST-72SD-12S-D4R(L)-FB-N).

■ **High-density polyurethane insulation**

The entire cabinet structure and solid doors are foamed-in-place high density, CFC free polyurethane insulation.

■ **9-1/2" deep, 1/2" thick high-density Polyethylene cutting board included with convenient side rail**

■ **Insulated pan cover**

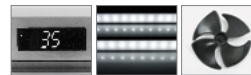
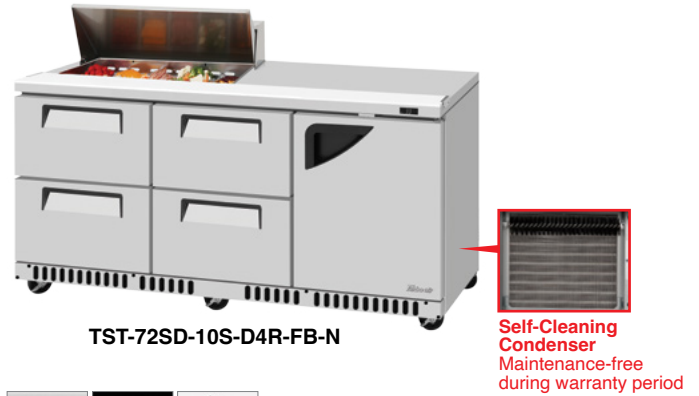

LED interior lighting & fan control

Energy efficient LED lighting lights every corner, making items easy to find. Fan control function automatically shuts off the fan when the door is open, which prevents hot air from being drawn in, thus maintaining the cool inner temperature (only TST-72SD-10S-D4R(L)-FB-N, TST-72SD-12S-LD2R-FB-N, TST-72SD-12S-D4R(L)-FB-N).

■ **Refrigerator holds 33°F ~ 39°F for the best in food preservation**

■ **Standard features**

- Anti-corrosion coated evaporator
- Self-contained system
- 4" dia. swivel casters with locks on the front set
- 1/6 size, 4" deep condiment pans included
- Lead time applies

■ **Optional features**

- Stainless steel single/double overself available
- Removable food covers available
- Legs available for all models: 6"
- Door locks available (extra lead time will apply)
- Casters available for all models: 1", 2.5", 5"

TST MODELS SPECIFICATIONS

ELECTRICAL DATA	TST-72SD-10S-D4R-FB-N(-LW) TST-72SD-10S-D4L-FB-N(-LW)	TST-72SD-10S-D6 -FB-N(-LW)	TST-72SD-12S-D2LR -FB-N(-LW)	TST-72SD-12S-D4R-FB-N(-LW) TST-72SD-12S-D4L-FB-N(-LW)	TST-72SD-12S-D6 -FB-N(-LW)
Voltage	115/60/1	115/60/1	115/60/1	115/60/1	115/60/1
Plug Type	Ⓜ NEMA 5-15P	Ⓜ NEMA 5-15P	Ⓜ NEMA 5-15P	Ⓜ NEMA 5-15P	Ⓜ NEMA 5-15P
Full Load Amp.	5.7	5.7	9.9	9.9	9.9
Compressor HP	2/5	2/5	3/8	3/8	3/8
Cord Length (ft.)	9	9	9	9	9
Refrigerant	R-290	R-290	R-290	R-290	R-290
DIMENSIONAL DATA					
Net Capacity (cu. ft.)	17.6	17.6	20.5	20.5	20.5
Ext. Dimension (L x D x H†) (in.)	72 ⁵ / ₈ x 30 x 42 ¹ / ₈	72 ⁵ / ₈ x 30 x 42 ¹ / ₈	72 ⁵ / ₈ x 30 x 37 ⁵ / ₈	72 ⁵ / ₈ x 30 x 37 ⁵ / ₈	72 ⁵ / ₈ x 30 x 37 ⁵ / ₈
# of Doors	1	-	2	1	-
# of Drawers	4	6	2	4	6
# of Shelves (Size (L x D) (in.))	1 (21 x 17)	-	2 (21 x 17 (L/R))	1 (21 x 17)	-
# of Pans	10	10	12	12	12
Net Weight (lbs.)	344	344	344	352	352
Gross Weight (lbs.)	372	372	372	392	392

Design and specifications subject to change without notice. Most updated spec sheets are available at www.turboairinc.com.

Actual shipping weight may differ due to extra packing materials for product protection.

† Height does not include 4-1/2" for caster height.

■ **WARRANTY: 5 Year Parts and Labor Warranty, 7 Year Compressor Warranty**

SANDWICH/SALAD UNITS - FRONT BREATHING AIRFLOW/SPECIALTY LIDS

Self-Cleaning Condenser Equipped Units



Prep + Work Stations - CL

Clear Lids
Right or left side workstation option

Model	Ext. dimension (L x D x H†) (in.)	Net / Gross Weight (lbs.)
TST-48SD-08S-FB-N-CL(-LW)	48 1/4 x 30 x 42 1/8	243 / 273
TST-60SD-08S-FB-N-CL(-LW)	60 1/4 x 30 x 42 1/8	284 / 316
TST-72SD-08S-FB-N-CL(-LW)	72 5/8 x 30 x 42 1/8	344 / 372
TST-72SD-10S-FB-N-CL(-LW)	72 5/8 x 30 x 42 1/8	344 / 372
TST-72SD-12S-FB-N-CL(-LW)	72 5/8 x 30 x 42 1/8	344 / 372

See page 138 for specification.



Prep + Work Stations - CL

Clear Lids / Drawers
Right or left side workstation option

Model	Ext. dimension (L x D x H†) (in.)	Net / Gross Weight (lbs.)
TST-48SD-08S-D2R-FB-N-CL(-LW)	48 1/4 x 30 x 42 1/8	243 / 273
TST-48SD-08S-D2L-FB-N-CL(-LW)	48 1/4 x 30 x 42 1/8	243 / 273
TST-48SD-08S-D4-FB-N-CL(-LW)	48 1/4 x 30 x 42 1/8	243 / 273
TST-60SD-08S-D2R-FB-N-CL(-LW)	60 1/4 x 30 x 42 1/8	284 / 316
TST-60SD-08S-D2L-FB-N-CL(-LW)	60 1/4 x 30 x 42 1/8	284 / 316
TST-60SD-08S-D4-FB-N-CL(-LW)	60 1/4 x 30 x 42 1/8	284 / 316
TST-72SD-08S-D2LR-FB-N-CL(-LW)	72 5/8 x 30 x 42 1/8	344 / 372
TST-72SD-08S-D4R-FB-N-CL(-LW)	72 5/8 x 30 x 42 1/8	344 / 372
TST-72SD-08S-D4L-FB-N-CL(-LW)	72 5/8 x 30 x 42 1/8	344 / 372
TST-72SD-08S-D6-FB-N-CL(-LW)	72 5/8 x 30 x 42 1/8	344 / 372
TST-72SD-10S-D2LR-FB-N-CL(-LW)	72 5/8 x 30 x 42 1/8	344 / 372
TST-72SD-10S-D4R-FB-N-CL(-LW)	72 5/8 x 30 x 42 1/8	344 / 372
TST-72SD-10S-D4L-FB-N-CL(-LW)	72 5/8 x 30 x 42 1/8	344 / 372
TST-72SD-10S-D6-FB-N-CL(-LW)	72 5/8 x 30 x 42 1/8	344 / 372
TST-72SD-12S-D2LR-FB-N-CL(-LW)	72 5/8 x 30 x 42 1/8	344 / 372
TST-72SD-12S-D4R-FB-N-CL(-LW)	72 5/8 x 30 x 42 1/8	344 / 372
TST-72SD-12S-D4L-FB-N-CL(-LW)	72 5/8 x 30 x 42 1/8	344 / 372
TST-72SD-12S-D6-FB-N-CL(-LW)	72 5/8 x 30 x 42 1/8	344 / 372

See pages 139-140 for specification.



Prep + Work Stations - FL

Flat Lids
Right or left side workstation option

Model	Ext. dimension (L x D x H†) (in.)	Net / Gross Weight (lbs.)
TST-48SD-08S-FB-N-FL(-LW)	48 1/4 x 30 x 37 3/8	243 / 273
TST-60SD-08S-FB-N-FL(-LW)	60 1/4 x 30 x 36 3/4	284 / 316
TST-72SD-08S-FB-N-FL(-LW)	72 5/8 x 30 x 36 3/4	344 / 372
TST-72SD-10S-FB-N-FL(-LW)	72 5/8 x 30 x 36 3/4	344 / 372
TST-72SD-12S-FB-N-FL(-LW)	72 5/8 x 30 x 36 3/4	344 / 372

See page 138 for specification.

Design and specifications subject to change without notice. Most updated spec sheets are available at www.turboairinc.com.

Actual shipping weight may differ due to extra packing materials for product protection.

† Height does not include 4-1/2" for caster height.

■ **WARRANTY: 5 Year Parts and Labor Warranty, 7 Year Compressor Warranty**

SANDWICH/SALAD UNITS - FRONT BREATHING AIRFLOW/SPECIALTY LIDS

Self-Cleaning Condenser Equipped Units



Prep + Work Stations - FL

Flat Lids / Drawer
No left side workstation option



Prep + Work Stations - FCL

Flat Clear Lids
No left side workstation option



Prep + Work Stations - FCL

Flat Clear Lids / Drawers
No left side workstation option

Model	Ext. dimension (L x D x H†) (in.)	Net / Gross Weight (lbs.)
TST-48SD-08S-D2R-FB-N-FL	48 1/4 x 30 x 37 3/8	243 / 273
TST-48SD-08S-D2L-FB-N-FL	48 1/4 x 30 x 37 3/8	243 / 273
TST-48SD-08S-D4-FB-N-FL	48 1/4 x 30 x 36 3/4	284 / 316
TST-60SD-08S-D2R-FB-N-FL	60 1/4 x 30 x 36 3/4	284 / 316
TST-60SD-08S-D2L-FB-N-FL	60 1/4 x 30 x 36 3/4	284 / 316
TST-60SD-08S-D4-FB-N-FL	60 1/4 x 30 x 36 3/4	344 / 372
TST-72SD-08S-D2LR-FB-N-FL	72 5/8 x 30 x 36 3/4	344 / 372
TST-72SD-08S-D4R-FB-N-FL	72 5/8 x 30 x 36 3/4	344 / 372
TST-72SD-08S-D4L-FB-N-FL	72 5/8 x 30 x 36 3/4	344 / 372
TST-72SD-08S-D6-FB-N-FL	72 5/8 x 30 x 36 3/4	344 / 372
TST-72SD-10S-D2LR-FB-N-FL	72 5/8 x 30 x 36 3/4	344 / 372
TST-72SD-10S-D4R-FB-N-FL	72 5/8 x 30 x 36 3/4	344 / 372
TST-72SD-10S-D4L-FB-N-FL	72 5/8 x 30 x 36 3/4	344 / 372
TST-72SD-10S-D6-FB-N-FL	72 5/8 x 30 x 36 3/4	344 / 372
TST-72SD-12S-D2LR-FB-N-FL	72 5/8 x 30 x 36 3/4	344 / 372
TST-72SD-12S-D4R-FB-N-FL	72 5/8 x 30 x 36 3/4	344 / 372
TST-72SD-12S-D4L-FB-N-FL	72 5/8 x 30 x 36 3/4	344 / 372
TST-72SD-12S-D6-FB-N-FL	72 5/8 x 30 x 36 3/4	344 / 372

See pages 139-140 for specification.

Model	Ext. dimension (L x D x H†) (in.)	Net / Gross Weight (lbs.)
TST-48SD-08S-FB-N-FCL	48 1/4 x 30 x 38	243 / 273
TST-60SD-08S-FB-N-FCL	60 1/4 x 30 x 38	284 / 316
TST-72SD-08S-FB-N-FCL	72 5/8 x 30 x 38	344 / 372
TST-72SD-10S-FB-N-FCL	72 5/8 x 30 x 38	344 / 372
TST-72SD-12S-FB-N-FCL	72 5/8 x 30 x 38	344 / 372

See page 138 for specification.

Model	Ext. dimension (L x D x H†) (in.)	Net / Gross Weight (lbs.)
TST-48SD-08S-D2R-FB-N-FCL	48 1/4 x 30 x 38	243 / 273
TST-48SD-08S-D2L-FB-N-FCL	48 1/4 x 30 x 38	243 / 273
TST-48SD-08S-D4-FB-N-FCL	48 1/4 x 30 x 38	243 / 273
TST-60SD-08S-D2R-FB-N-FCL	60 1/4 x 30 x 38	284 / 316
TST-60SD-08S-D2L-FB-N-FCL	60 1/4 x 30 x 38	284 / 316
TST-60SD-08S-D4-FB-N-FCL	60 1/4 x 30 x 38	284 / 316
TST-72SD-08S-LD2R-FB-N-FCL	72 5/8 x 30 x 38	344 / 372
TST-72SD-08S-D4R-FB-N-FCL	72 5/8 x 30 x 38	344 / 372
TST-72SD-08S-D4L-FB-N-FCL	72 5/8 x 30 x 38	344 / 372
TST-72SD-08S-D6-FB-N-FCL	72 5/8 x 30 x 38	344 / 372
TST-72SD-10S-LD2R-FB-N-FCL	72 5/8 x 30 x 38	344 / 372
TST-72SD-10S-D4R-FB-N-FCL	72 5/8 x 30 x 38	344 / 372
TST-72SD-10S-D4L-FB-N-FCL	72 5/8 x 30 x 38	344 / 372
TST-72SD-10S-D6-FB-N-FCL	72 5/8 x 30 x 38	344 / 372
TST-72SD-12S-LD2R-FB-N-FCL	72 5/8 x 30 x 38	344 / 372
TST-72SD-12S-D4R-FB-N-FCL	72 5/8 x 30 x 38	344 / 372
TST-72SD-12S-D4L-FB-N-FCL	72 5/8 x 30 x 38	344 / 372
TST-72SD-12S-D6-FB-N-FCL	72 5/8 x 30 x 38	344 / 372

See pages 139-140 for specification.

Design and specifications subject to change without notice. Most updated spec sheets are available at www.turboairinc.com.

Actual shipping weight may differ due to extra packing materials for product protection.

† Height does not include 4-1/2" for caster height.

■ **WARRANTY: 5 Year Parts and Labor Warranty, 7 Year Compressor Warranty**

MEGA TOP UNITS - FRONT BREATHING AIRFLOW NATURAL Refrigerant

Self-Cleaning Condenser Equipped Units

■ **Self-Cleaning Condenser (Patented)**

The accumulation of dust in the condenser can cause the failure or breakdown of refrigerators. Refrigerators run normally until they reach a certain level of accumulation. At some point, when they are over the limit, their performance drops quickly resulting in damage to, or disposal of the stored products inside. The Self-Cleaning Condenser device keeps the condenser clean and prevents system failure by automatically brushing daily.

■ **Digital temperature control & monitor system**

Keeps food products safe by maintaining constant temperatures. External digital display allows for easy monitoring.

■ **Front Breathing airflow**

Front Breathing airflow is designed to draw in air and discharge from the front, allowing units to run at high efficiency in tight spaces and eliminates the need for surrounding clearances.

■ **Hydrocarbon refrigerants (R-290)**

With innovative and eco-friendly technology, Turbo Air brings you hydrocarbon refrigerators designed to meet DOE's Energy Conservation Standards in 2017 and to use EPA's SNAP Program approved HC refrigerants. Hydrocarbon refrigerants do not deplete the ozone layer and have very low contribution to global warming (ODP-0, GWP-3).

■ **Stainless steel cabinet construction**

The Turbo Air Super Deluxe model boasts a stainless steel interior (ABS door liner) and exterior (galvanized steel back & bottom). It guarantees the utmost in cleanliness and long product life. The Super Deluxe adds a touch of style to the most refined setting.

■ **Sturdy, clean stainless steel shelving**

Shelves are the most important part of cleanliness as they come in direct contact with food. After a while, PVC coated wire shelves may peel, rust and lead to unsanitary conditions. The Super Deluxe series uniquely provides stainless steel shelving.

■ **High-density polyurethane insulation**

The entire cabinet structure and solid doors are foamed-in-place high density, CFC free polyurethane insulation.

■ **9-1/2" deep, 1/2" thick high-density Polyethylene cutting board included with convenient side rail**

■ **Insulated pan cover**

■ **Refrigerator holds 33°F ~ 39°F for the best in food preservation**

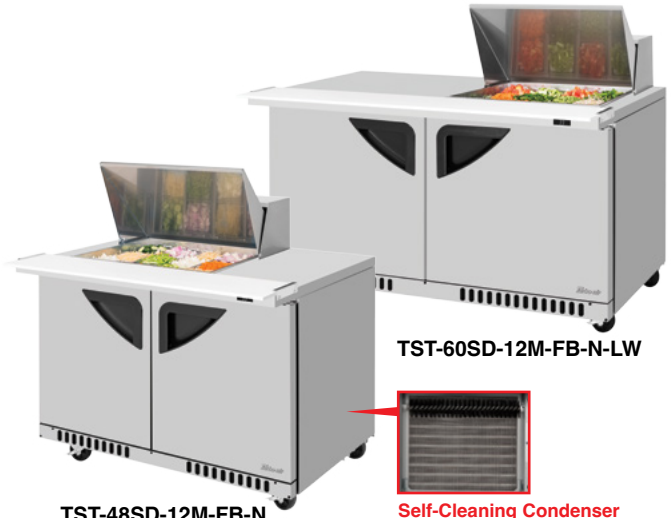

TST-60SD-12M-FB-N-LW

TST-48SD-12M-FB-N

Self-Cleaning Condenser
Maintenance-free during warranty period

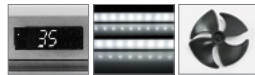

LED interior lighting & fan control

Energy efficient LED lighting lights every corner, making items easy to find. Fan control function automatically shuts off the fan when the door is open, which prevents hot air from being drawn in, thus maintaining the cool inner temperature.

■ **Standard features**

- Anti-corrosion coated evaporator
- Self-contained system
- 4" dia. swivel casters with locks on the front set
- 1/6 size, 4" deep condiment pans included
- Lead time applies

■ **Optional features**

- Stainless steel single/double overself available
- Removable food covers available
- Legs available for all models: 6"
- Door locks available (extra lead time will apply)
- Casters available for all models: 1", 2.5", 5"

TST MODELS SPECIFICATIONS

ELECTRICAL DATA	TST-48SD-12M-FB-N(-LW)	TST-60SD-12M-FB-N(-LW)	TST-60SD-18M-FB-N(-LW)	TST-72SD-15M-FB-N(-LW)	TST-72SD-18M-FB-N(-LW)
Voltage	115/60/1	115/60/1	115/60/1	115/60/1	115/60/1
Plug Type	Ⓜ NEMA 5-15P	Ⓜ NEMA 5-15P	Ⓜ NEMA 5-15P	Ⓜ NEMA 5-15P	Ⓜ NEMA 5-15P
Full Load Amp.	8.9	8.9	8.9	9.9	9.9
Compressor HP	1/5	1/5	1/5	3/8	3/8
Cord Length (ft.)	10	9	9	10	10
Refrigerant	R-290	R-290	R-290	R-290	R-290
DIMENSIONAL DATA					
Net Capacity (cu. ft.)	11.1	14.8	14.8	20.5	23
Ext. Dimension (L x D* x H†) (in.)	48 1/4 x 37 x 44 1/8	60 1/4 x 37 x 44 1/8	60 1/4 x 37 x 44 1/8	72 3/4 x 37 x 44 1/8	72 3/4 x 37 x 44 1/8
# of Doors	2	2	2	3	3
# of Shelves (Size (L x D) (in.))	2 (21 x 17)	2 (21 x 17)	2 (21 x 17)	3 (21 x 17)	3 (21 x 17)
# of Pans	12	12	18	15	18
Net Weight (lbs.)	244	294	294	344	344
Gross Weight (lbs.)	264	326	326	372	372

Design and specifications subject to change without notice. Most updated spec sheets are available at www.turboairinc.com.

Actual shipping weight may differ due to extra packing materials for product protection.

* Depth does not include 3" for cutting boards. † Height does not include 4-1/2" for caster height.

■ **WARRANTY: 5 Year Parts and Labor Warranty, 7 Year Compressor Warranty**

MEGA TOP UNITS - FRONT BREATHING AIRFLOW/DRAWERS NATURAL Refrigerant

Self-Cleaning Condenser Equipped Units

■ **Self-Cleaning Condenser (Patented)**

The accumulation of dust in the condenser can cause the failure or breakdown of refrigerators. Refrigerators run normally until they reach a certain level of accumulation. At some point, when they are over the limit, their performance drops quickly resulting in damage to, or disposal of the stored products inside. The Self-Cleaning Condenser device keeps the condenser clean and prevents system failure by automatically brushing daily.

■ **Digital temperature control & monitor system**

Keeps food products safe by maintaining constant temperatures. External digital display allows for easy monitoring.

■ **Front Breathing airflow**

Front Breathing airflow is designed to draw in air and discharge from the front, allowing units to run at high efficiency in tight spaces and eliminates the need for surrounding clearances.

■ **Hydrocarbon refrigerants (R-290)**

With innovative and eco-friendly technology, Turbo Air brings you hydrocarbon refrigerators designed to meet DOE's Energy Conservation Standards in 2017 and to use EPA's SNAP Program approved HC refrigerants. Hydrocarbon refrigerants do not deplete the ozone layer and have very low contribution to global warming (ODP-0, GWP-3).

■ **Stainless steel cabinet construction**

The Turbo Air Super Deluxe model boasts a stainless steel interior (ABS door liner) and exterior (galvanized steel back & bottom) including durable stainless steel drawers. It guarantees the utmost in cleanliness and long product life. The Super Deluxe adds a touch of style to the most refined setting.

■ **Sturdy, clean stainless steel shelving**

Shelves are the most important part of cleanliness as they come in direct contact with food. After a while, PVC coated wire shelves may peel, rust and lead to unsanitary conditions. The Super Deluxe series uniquely provides stainless steel shelving (only TST-48SD-12M-D2R(L)-FB-N, TST-60SD-12M-D2R(L)-FB-N).

■ **9-1/2" deep, 1/2" thick high-density Polyethylene cutting board included with convenient side rail**

■ **Insulated pan cover**

■ **Ergonomically designed doors & drawers**

Customers' fatigue fades away with easy door grip and drawers that open effortlessly. These features along with self-closing doors make this the ultimate choice in customer convenience. ABS sheet door liners resist water condensation with thermal efficiency.



TST-48SD-12M-D2R-FB-N

Each drawer accommodates up to 6" deep sixth (1/6) size pans

TST-60SD-12M-D4-FB-N-LW

Self-Cleaning Condenser
Maintenance-free during warranty period

■ **Refrigerator holds 33°F ~ 39°F for the best in food preservation**

■ **Standard features**

- Anti-corrosion coated evaporator
- Self-contained system
- 4" dia. swivel casters with locks on the front set
- 1/6 size, 4" deep condiment pans included (top of cabinet)
- Lead time applies

■ **Optional features**

- Stainless steel single/double overshelf available
- Clear lids available
- Removable food covers available
- Legs available for all models: 6"
- Casters available for all models: 1", 2.5", 5"

TST MODELS SPECIFICATIONS

ELECTRICAL DATA	TST-48SD-12M-D2R-FB-N(-LW) TST-48SD-12M-D2L-FB-N(-LW)	TST-48SD-12M-D4 -FB-N(-LW)	TST-60SD-12M-D2R-FB-N(-LW) TST-60SD-12M-D2L-FB-N(-LW)	TST-60SD-12M-D4 -FB-N(-LW)
Voltage	115/60/1	115/60/1	115/60/1	115/60/1
Plug Type	Ⓜ NEMA 5-15P	Ⓜ NEMA 5-15P	Ⓜ NEMA 5-15P	Ⓜ NEMA 5-15P
Full Load Amp.	6.5	6.5	8.9	8.9
Compressor HP	1/5	1/5	1/5	1/5
Cord Length (ft.)	9	9	9	9
Refrigerant	R-290	R-290	R-290	R-290
DIMENSIONAL DATA				
Net Capacity (cu. ft.)	13.4	13.4	14.8	16.9
Ext. Dimension (L x D* x H†) (in.)	48 1/4 x 34 x 39 5/8	48 1/4 x 34 x 39 5/8	60 1/4 x 37 x 44 1/8	60 1/4 x 34 x 39 5/8
# of Doors	1	-	1	-
# of Drawers	2	4	2	4
# of Shelves (Size (L x D) (in.))	1 (21 x 17)	-	1 (21 x 17)	-
# of Pans	12	12	12	12
Net Weight (lbs.)	239	239	294	280
Gross Weight (lbs.)	269	269	326	312

Design and specifications subject to change without notice. Most updated spec sheets are available at www.turboairinc.com.

Actual shipping weight may differ due to extra packing materials for product protection.

* Depth does not include 3" for cutting boards. † Height does not include 4-1/2" for caster height.

■ **WARRANTY: 5 Year Parts and Labor Warranty, 7 Year Compressor Warranty**

MEGA TOP UNITS - FRONT BREATHING AIRFLOW/DRAWERS NATURAL Refrigerant

Self-Cleaning Condenser Equipped Units

■ **Self-Cleaning Condenser (Patented)**

The accumulation of dust in the condenser can cause the failure or breakdown of refrigerators. Refrigerators run normally until they reach a certain level of accumulation. At some point, when they are over the limit, their performance drops quickly resulting in damage to, or disposal of the stored products inside. The Self-Cleaning Condenser device keeps the condenser clean and prevents system failure by automatically brushing daily.

■ **Digital temperature control & monitor system**

Keeps food products safe by maintaining constant temperatures. External digital display allows for easy monitoring.

■ **Front Breathing airflow**

Front Breathing airflow is designed to draw in air and discharge from the front, allowing units to run at high efficiency in tight spaces and eliminates the need for surrounding clearances.

■ **Hydrocarbon refrigerants (R-290)**

With innovative and eco-friendly technology, Turbo Air brings you hydrocarbon refrigerators designed to meet DOE's Energy Conservation Standards in 2017 and to use EPA's SNAP Program approved HC refrigerants. Hydrocarbon refrigerants do not deplete the ozone layer and have very low contribution to global warming (ODP-0, GWP-3).

■ **Stainless steel cabinet construction**

The Turbo Air Super Deluxe model boasts a stainless steel interior (ABS door liner) and exterior (galvanized steel back & bottom) including durable stainless steel drawers. It guarantees the utmost in cleanliness and long product life. The Super Deluxe adds a touch of style to the most refined setting.

■ **Sturdy, clean stainless steel shelving**

Shelves are the most important part of cleanliness as they come in direct contact with food. After a while, PVC coated wire shelves may peel, rust and lead to unsanitary conditions. The Super Deluxe series uniquely provides stainless steel shelving (except TST-60SD-18M-D4-FB-N).

■ **9-1/2" deep, 1/2" thick high-density Polyethylene cutting board included with convenient side rail**

■ **Insulated pan cover**

■ **Ergonomically designed doors & drawers**

Customers' fatigue fades away with easy door grip and drawers that open effortlessly. These features along with self-closing doors make this the ultimate choice in customer convenience. ABS sheet door liners resist water condensation with thermal efficiency.



■ **Refrigerator holds 33°F ~ 39°F for the best in food preservation**

■ **Standard features**

- Anti-corrosion coated evaporator
- Self-contained system
- 4" dia. swivel casters with locks on the front set
- 1/6 size, 4" deep condiment pans included (top of cabinet)
- Lead time applies

■ **Optional features**

- Stainless steel single/double overshelf available
- Clear lids available
- Removable food covers available
- Legs available for all models: 6"
- Casters available for all models: 1", 2.5", 5"

TST MODELS SPECIFICATIONS

ELECTRICAL DATA	TST-60SD-18M-D2R-FB-N(-LW) TST-60SD-18M-D2L-FB-N(-LW)	TST-60SD-18M-D4 -FB-N(-LW)	TST-72SD-15M -D2LR-FB-N(-LW)	TST-72SD-15M-D4R-FB-N(-LW) TST-72SD-15M-D4L-FB-N(-LW)
Voltage	115/60/1	115/60/1	115/60/1	115/60/1
Plug Type	Ⓜ NEMA 5-15P	Ⓜ NEMA 5-15P	Ⓜ NEMA 5-15P	Ⓜ NEMA 5-15P
Full Load Amp.	8.9	8.9	9.9	9.9
Compressor HP	1/5	1/5	3/8	3/8
Cord Length (ft.)	9	9	10	10
Refrigerant	R-290	R-290	R-290	R-290
DIMENSIONAL DATA				
Net Capacity (cu. ft.)	14.8	14.8	23	23
Ext. Dimension (L x D* x H†) (in.)	60 ^{1/4} x 37 x 44 ^{1/8}	60 ^{1/4} x 37 x 44 ^{1/8}	72 ^{3/4} x 37 x 44 ^{1/8}	72 ^{3/4} x 37 x 44 ^{1/8}
# of Doors	1	-	2	1
# of Drawers	2	4	2	4
# of Shelves (Size (L x D) (in.))	1 (21 x 17)	-	2 (21 x 17 (L/R))	1 (21 x 17)
# of Pans	18	18	15	15
Net Weight (lbs.)	294	280	344	344
Gross Weight (lbs.)	326	312	372	372

Design and specifications subject to change without notice. Most updated spec sheets are available at www.turboairinc.com.

Actual shipping weight may differ due to extra packing materials for product protection.

* Depth does not include 3" for cutting boards. † Height does not include 4-1/2" for caster height.

■ **WARRANTY: 5 Year Parts and Labor Warranty, 7 Year Compressor Warranty**

MEGA TOP UNITS - FRONT BREATHING AIRFLOW/DRAWERS

Self-Cleaning Condenser Equipped Units

■ **Self-Cleaning Condenser (Patented)**

The accumulation of dust in the condenser can cause the failure or breakdown of refrigerators. Refrigerators run normally until they reach a certain level of accumulation. At some point, when they are over the limit, their performance drops quickly resulting in damage to, or disposal of the stored products inside. The Self-Cleaning Condenser device keeps the condenser clean and prevents system failure by automatically brushing daily.

■ **Digital temperature control & monitor system**

Keeps food products safe by maintaining constant temperatures. External digital display allows for easy monitoring.

■ **Front Breathing airflow**

Front Breathing airflow is designed to draw in air and discharge from the front, allowing units to run at high efficiency in tight spaces and eliminates the need for surrounding clearances.

■ **Hydrocarbon refrigerants (R-290)**

With innovative and eco-friendly technology, Turbo Air brings you hydrocarbon refrigerators designed to meet DOE's Energy Conservation Standards in 2017 and to use EPA's SNAP Program approved HC refrigerants. Hydrocarbon refrigerants do not deplete the ozone layer and have very low contribution to global warming (ODP-0, GWP-3).

■ **Stainless steel cabinet construction**

The Turbo Air Super Deluxe model boasts a stainless steel interior (ABS door liner) and exterior (galvanized steel back & bottom) including durable stainless steel drawers. It guarantees the utmost in cleanliness and long product life. The Super Deluxe adds a touch of style to the most refined setting.

■ **Sturdy, clean stainless steel shelving**

Shelves are the most important part of cleanliness as they come in direct contact with food. After a while, PVC coated wire shelves may peel, rust and lead to unsanitary conditions. The Super Deluxe series uniquely provides stainless steel shelving (only TST-72SD-18M-LD2R-FB-N, TST-72SD-18M-D4R(L)-FB-N).

■ **9-1/2" deep, 1/2" thick high-density Polyethylene cutting board included with convenient side rail**

■ **Insulated pan cover**

■ **Ergonomically designed doors & drawers**

Customers' fatigue fades away with easy door grip and drawers that open effortlessly. These features along with self-closing doors make this the ultimate choice in customer convenience. ABS sheet door liners resist water condensation with thermal efficiency.



TST-72SD-15M-D6-FB-N

Each drawer accommodates up to 6" deep sixth (1/6) size pans

TST-72SD-18M-LD2R-FB-N

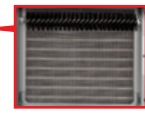

Self-Cleaning Condenser Maintenance-free during warranty period

■ **Refrigerator holds 33°F ~ 39°F for the best in food preservation**

■ **Standard features**

- Anti-corrosion coated evaporator
- Self-contained system
- 4" dia. swivel casters with locks on the front set
- 1/6 size, 4" deep condiment pans included (top of cabinet)
- Lead time applies

■ **Optional features**

- Stainless steel single/double overshef available
- Clear lids available
- Removable food covers available
- Legs available for all models: 6"
- Casters available for all models: 1", 2.5", 5"

TST MODELS SPECIFICATIONS

ELECTRICAL DATA	TST-72SD-15M-D6 -FB-N(-LW)	TST-72SD-18M-D2LR -FB-N(-LW)	TST-72SD-18M-D4R-FB-N(-LW) TST-72SD-18M-D4L-FB-N(-LW)	TST-72SD-18M-D6 -FB-N(-LW)
Voltage	115/60/1	115/60/1	115/60/1	115/60/1
Plug Type	Ⓜ NEMA 5-15P	Ⓜ NEMA 5-15P	Ⓜ NEMA 5-15P	Ⓜ NEMA 5-15P
Full Load Amp.	9.9	9.9	9.9	9.9
Compressor HP	3/8	3/8	3/8	3/8
Cord Length (ft.)	10	10	10	10
Refrigerant	R-290	R-290	R-290	R-290
DIMENSIONAL DATA				
Net Capacity (cu. ft.)	23	23	23	23
Ext. Dimension (L x D* x H†) (in.)	72 ³ / ₄ x 37 x 44 ¹ / ₈	72 ³ / ₄ x 37 x 44 ¹ / ₈	72 ³ / ₄ x 37 x 44 ¹ / ₈	72 ³ / ₄ x 37 x 44 ¹ / ₈
# of Doors	-	2	1	-
# of Drawers	6	2	4	6
# of Shelves (Size (L x D) (in.))	-	2 (21 x 17)	1 (21 x 17)	-
# of Pans	15	18	18	18
Net Weight (lbs.)	344	344	344	344
Gross Weight (lbs.)	372	372	372	372

Design and specifications subject to change without notice. Most updated spec sheets are available at www.turboairinc.com.

Actual shipping weight may differ due to extra packing materials for product protection.

* Depth does not include 3" for cutting boards. † Height does not include 4-1/2" for caster height.

■ **WARRANTY: 5 Year Parts and Labor Warranty, 7 Year Compressor Warranty**

MEGA TOP UNITS - FRONT BREATHING AIRFLOW/SPECIALTY LIDS

Self-Cleaning Condenser Equipped Units



Prep + Work Stations - CL

Clear Lids
No left side workstation option

Model	Ext. dimension (L x D* x H†) (in.)	Net / Gross Weight (lbs.)
TST-48SD-12M-FB-N-CL	48 1/4 x 37 x 44 1/8	244 / 264
TST-60SD-12M-FB-N-CL	60 1/4 x 37 x 44 1/8	294 / 326
TST-72SD-15M-FB-N-CL	72 3/4 x 37 x 44 1/8	344 / 372

See page 144 for specification.



Prep + Work Stations - CL

Clear Lids / Drawers
No left side workstation option

Model	Ext. dimension (L x D* x H†) (in.)	Net / Gross Weight (lbs.)
TST-48SD-12M-D4-FB-N-CL	48 1/4 x 37 x 44 1/8	244 / 264
TST-48SD-12M-D2R-FB-N-CL	48 1/4 x 37 x 44 1/8	244 / 264
TST-48SD-12M-D2L-FB-N-CL	48 1/4 x 37 x 44 1/8	244 / 264
TST-60SD-12M-D4-FB-N-CL	60 1/4 x 37 x 44 1/8	294 / 326
TST-60SD-12M-D2R-FB-N-CL	60 1/4 x 37 x 44 1/8	294 / 326
TST-60SD-12M-D2L-FB-N-CL	60 1/4 x 37 x 44 1/8	344 / 372
TST-72SD-15M-D6-FB-N-CL	72 3/4 x 37 x 44 1/8	344 / 372
TST-72SD-15M-D4R-FB-N-CL	72 3/4 x 37 x 44 1/8	344 / 372
TST-72SD-15M-D4L-FB-N-CL	72 3/4 x 37 x 44 1/8	344 / 372
TST-72SD-15M-D2LR-FB-N-CL	72 3/4 x 37 x 44 1/8	244 / 264

See pages 145-146 for specification.



Prep + Work Stations - FL

Flat Lids
No left side workstation option

Model	Ext. dimension (L x D* x H†) (in.)	Net / Gross Weight (lbs.)
TST-48SD-12M-FB-N-FL	48 1/4 x 37 x 37 3/8	244 / 264
TST-60SD-12M-FB-N-FL	60 1/4 x 37 x 36 3/4	294 / 326
TST-72SD-15M-FB-N-FL	72 3/4 x 37 x 36 7/8	344 / 372

See page 144 for specification.



Prep + Work Stations - FL

Flat Lids / Drawers
No left side workstation option

Model	Ext. dimension (L x D* x H†) (in.)	Net / Gross Weight (lbs.)
TST-48SD-12M-D2R-FB-N-FL	48 1/4 x 37 x 37 3/8	244 / 264
TST-48SD-12M-D2L-FB-N-FL	48 1/4 x 37 x 37 3/8	244 / 264
TST-48SD-12M-D4-FB-N-FL	48 1/4 x 37 x 37 3/8	244 / 264
TST-60SD-12M-D2R-FB-N-FL	60 1/4 x 37 x 36 3/4	294 / 326
TST-60SD-12M-D2L-FB-N-FL	60 1/4 x 37 x 36 3/4	294 / 326
TST-60SD-12M-D4-FB-N-FL	60 1/4 x 37 x 36 3/4	294 / 326
TST-72SD-15M-D4R-FB-N-FL	72 3/4 x 37 x 36 7/8	344 / 372
TST-72SD-15M-D4L-FB-N-FL	72 3/4 x 37 x 36 7/8	344 / 372
TST-72SD-15M-D2LR-FB-N-FL	72 3/4 x 37 x 36 7/8	344 / 372
TST-72SD-15M-D6-FB-N-FL	72 3/4 x 37 x 36 7/8	344 / 372

See pages 145-146 for specification.

Design and specifications subject to change without notice. Most updated spec sheets are available at www.turboairinc.com.

Actual shipping weight may differ due to extra packing materials for product protection.

* Depth does not include 3" for cutting boards. † Height does not include 4-1/2" for caster height.

■ **WARRANTY: 5 Year Parts and Labor Warranty, 7 Year Compressor Warranty**

MEGA TOP UNITS - FRONT BREATHING AIRFLOW/SPECIALTY LIDS

Self-Cleaning Condenser Equipped Units



Prep + Work Stations - FCL

Flat Clear Lids
No left side workstation option

Model	Ext. dimension (L x D* x H†) (in.)	Net / Gross Weight (lbs.)
TST-48SD-12M-FB-N-FCL	48 1/4 x 37 x 37 3/8	244 / 264
TST-60SD-12M-FB-N-FCL	60 1/4 x 37 x 36 3/4	294 / 326
TST-72SD-15M-FB-N-FCL	72 3/4 x 37 x 36 7/8	344 / 372

See page 144 for specification.



Prep + Work Stations - FCL

Flat Clear Lids / Drawers
No left side workstation option

Model	Ext. dimension (L x D* x H†) (in.)	Net / Gross Weight (lbs.)
TST-48SD-12M-D2R-FB-N-FCL	48 1/4 x 37 x 37 3/8	244 / 264
TST-48SD-12M-D2L-FB-N-FCL	48 1/4 x 37 x 37 3/8	244 / 264
TST-48SD-12M-D4-FB-N-FCL	48 1/4 x 37 x 37 3/8	244 / 264
TST-60SD-12M-D2R-FB-N-FCL	60 1/4 x 37 x 36 3/4	294 / 326
TST-60SD-12M-D2L-FB-N-FCL	60 1/4 x 37 x 36 3/4	294 / 326
TST-60SD-12M-D4-FB-N-FCL	60 1/4 x 37 x 36 3/4	294 / 326
TST-72SD-15M-D4R-FB-N-FCL	72 3/4 x 37 x 36 7/8	344 / 372
TST-72SD-15M-D4L-FB-N-FCL	72 3/4 x 37 x 36 7/8	344 / 372
TST-72SD-15M-D2LR-FB-N-FCL	72 3/4 x 37 x 36 7/8	344 / 372
TST-72SD-15M-D6-FB-N-FCL	72 3/4 x 37 x 36 7/8	344 / 372

See pages 145-146 for specification.

Design and specifications subject to change without notice. Most updated spec sheets are available at www.turboairinc.com.

Actual shipping weight may differ due to extra packing materials for product protection.

* Depth does not include 3" for cutting boards. † Height does not include 4-1/2" for caster height.

■ **WARRANTY: 5 Year Parts and Labor Warranty, 7 Year Compressor Warranty**

SANDWICH/SALAD UNITS NATURAL Refrigerant

Self-Cleaning Condenser Equipped Units

■ **Self-Cleaning Condenser (Patented)**

The accumulation of dust in the condenser can cause the failure or breakdown of refrigerators. Refrigerators run normally until they reach a certain level of accumulation. At some point, when they are over the limit, their performance drops quickly resulting in damage to, or disposal of the stored products inside. The Self-Cleaning Condenser device keeps the condenser clean and prevents system failure by automatically brushing daily.

■ **Digital temperature control & monitor system**

Keeps food products safe by maintaining constant temperatures. External digital display allows for easy monitoring.

■ **Hydrocarbon refrigerants (R-290 / R-600a)**

With innovative and eco-friendly technology, Turbo Air brings you hydrocarbon refrigerators designed to meet DOE's Energy Conservation Standards in 2017 and to use EPA's SNAP Program approved HC refrigerants. Hydrocarbon refrigerants do not deplete the ozone layer and have very low contribution to global warming (ODP-0, GWP-3).

■ **Cold Bunker system**

Our innovative forced air system allows cold air to flow all around the food pan area, covering not only underneath the pan, but also the front, top and the rear. This unique air flow creates a cold air-shield around the pan, which maintains the food temperature at under 41°F (NSF requirement) even when the lids are opened. In addition, the compartment isolates pans from the reach-in area to prevent food spillage.

■ **Stainless steel exterior**

The Turbo Air M3 model boasts a stainless steel exterior (galvanized steel back and bottom). Interior is AL cabinet with stainless steel floor and ABS door liner. It guarantees the utmost in cleanliness and long product life. The M3 model adds a touch of style to the most refined setting.

■ **Field reversible hinge (only MST-28-N)**

■ **Insulated pan cover**

■ **9-1/2" deep, 1/2" thick high-density Polyethylene cutting board included with convenient side rail**

■ **Adjustable, heavy duty, PE (polyethylene) coated wire shelves**

■ **Refrigerator holds 33°F ~ 39°F for the best in food preservation**



Self-Cleaning Condenser
Maintenance-free during warranty period

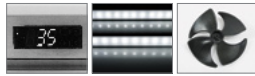

LED interior lighting & fan control

Energy efficient LED lighting lights every corner, making items easy to find. Fan control function automatically shuts off the fan when the door is open, which prevents hot air from being drawn in, thus maintaining the cool inner temperature.

■ **Standard features**

- Anti-corrosion coated evaporator
- Self-contained system
- 4" dia. swivel casters with locks on the front set
- 1/6 size, 4" deep condiment pans included
- High-density polyurethane insulation

■ **Optional features**

- Stainless steel single overself available (except MST-28-N, MST-36-N6)
- Stainless steel double overself available (except MST-28-N)
- Clear lids available
- Removable food covers available
- Legs available for all models: 6"
- Door locks available (extra lead time will apply)
- Casters available for all models: 1", 2.5", 5"

MST MODELS SPECIFICATIONS

ELECTRICAL DATA	MST-28-N	MST-36-N6	MST-48-N	MST-60-N	MST-72-N
Voltage	115/60/1	115/60/1	115/60/1	115/60/1	115/60/1
Plug Type	Ⓢ NEMA 5-15P	Ⓢ NEMA 5-15P	Ⓢ NEMA 5-15P	Ⓢ NEMA 5-15P	Ⓢ NEMA 5-15P
Full Load Amp.	3.8	3.9	4.4	4.4	5.7
Compressor HP	1/6	1/5	1/5	1/5	2/5
Cord Length (ft.)	9	9	9	9	9
Refrigerant	R-290	R-600a	R-290	R-290	R-290
DIMENSIONAL DATA					
Net Capacity (cu. ft.)	7	9.5	12	17	19
Ext. Dimension (L x D x H) (in.)	27 1/2 x 30* x 37 5/8†	36 3/8 x 30* x 37 5/8†	48 1/4 x 30* x 37 5/8†	60 1/4 x 30* x 37 5/8†	72 5/8 x 30* x 37 1/2‡
# of Doors	1	2	2	2	3
# of Shelves (Size (L x D) (in.))	1 (22 1/2 x 17)	2 (15 x 17)	2 (21 x 17)	2 (27 x 17)	3 (21 x 17 (L/R), 23 x 17 (M))
# of Pan	8	10	12	16	18
Net Weight (lbs.)	181	205	225	308	325
Gross Weight (lbs.)	198	220	242	330	374

Design and specifications subject to change without notice. Most updated spec sheets are available at www.turboairinc.com.

Actual shipping weight may differ due to extra packing materials for product protection.

* Depth does not include 1" for rear spacers. † Height does not include 5" for caster height. ‡ Height does not include 4-3/4" for caster height.

■ **WARRANTY: 5 Year Parts and Labor Warranty, 7 Year Compressor Warranty**

MEGA TOP UNITS NATURAL Refrigerant

Self-Cleaning Condenser Equipped Units

■ **Self-Cleaning Condenser (Patented)**

The accumulation of dust in the condenser can cause the failure or breakdown of refrigerators. Refrigerators run normally until they reach a certain level of accumulation. At some point, when they are over the limit, their performance drops quickly resulting in damage to, or disposal of the stored products inside. The Self-Cleaning Condenser device keeps the condenser clean and prevents system failure by automatically brushing daily.

■ **Digital temperature control & monitor system**

Keeps food products safe by maintaining constant temperatures. External digital display allows for easy monitoring.

■ **Hydrocarbon refrigerants (R-290 / R-600a)**

With innovative and eco-friendly technology, Turbo Air brings you hydrocarbon refrigerators designed to meet DOE's Energy Conservation Standards in 2017 and to use EPA's SNAP Program approved HC refrigerants. Hydrocarbon refrigerants do not deplete the ozone layer and have very low contribution to global warming (ODP-0, GWP-3).

■ **Cold Bunker system**

Our innovative forced air system allows cold air to flow all around the food pan area, covering not only underneath the pan, but also the front, top and the rear. This unique air flow creates a cold air-shield around the pan, which maintains the food temperature at under 41°F (NSF requirement) even when the lids are opened. In addition, the compartment isolates pans from the reach-in area to prevent food spillage.

■ **Stainless steel exterior**

The Turbo Air M3 model boasts a stainless steel exterior (galvanized steel back and bottom). Interior is AL with stainless steel floor and ABS door liner. It guarantees the utmost in cleanliness and long product life. The M3 model adds a touch of style to the most refined setting.

■ **Field reversible hinge (only MST-28-12-N)**

■ **Insulated pan cover**

■ **9-1/2" deep, 1/2" thick high-density Polyethylene cutting board included with convenient side rail**

■ **Adjustable, heavy duty, PE (polyethylene) coated wire shelves**

■ **Refrigerator holds 33°F ~ 39°F for the best in food preservation**

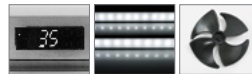

LED interior lighting & fan control

Energy efficient LED lighting lights every corner, making items easy to find. Fan control function automatically shuts off the fan when the door is open, which prevents hot air from being drawn in, thus maintaining the cool inner temperature.

■ **Standard features**

- Anti-corrosion coated evaporator
- Self-contained system
- 4" dia. swivel casters with locks on the front set
- 1/6 size, 4" deep condiment pans included
- High-density polyurethane insulation

■ **Optional features**

- Stainless steel single overshef available (except MST-28-12-N, MST-36-15-N6)
- Stainless steel double overshef available (except MST-28-12-N)
- Clear lids available
- Removable food covers available
- Legs available for all models: 6"
- Door locks available (extra lead time will apply)
- Casters available for all models: 1", 2.5", 5"

MST MODELS SPECIFICATIONS

ELECTRICAL DATA	MST-28-12-N	MST-36-15-N6	MST-48-18-N	MST-60-24-N	MST-72-30-N
Voltage	115/60/1	115/60/1	115/60/1	115/60/1	115/60/1
Plug Type	Ⓜ NEMA 5-15P	Ⓜ NEMA 5-15P	Ⓜ NEMA 5-15P	Ⓜ NEMA 5-15P	Ⓜ NEMA 5-15P
Full Load Amp.	3.8	2.9	4.4	4.4	5.7
Compressor HP	1/6	1/5	1/5	1/5	2/5
Cord Length (ft.)	9	9	9	9	9
Refrigerant	R-290	R-600a	R-290	R-290	R-290
DIMENSIONAL DATA					
Net Capacity (cu. ft.)	8	11	15	19	23
Ext. Dimension (L x D x H) (in.)	27 ¹ / ₂ x 34 ⁺ x 39 ⁵ / ₈ [†]	36 ³ / ₈ x 34 ⁺ x 39 ⁵ / ₈ [†]	48 ¹ / ₄ x 34 ⁺ x 39 ⁵ / ₈ [†]	60 ¹ / ₄ x 34 ⁺ x 39 ⁵ / ₈ [†]	72 ⁵ / ₈ x 34 ⁺ x 39 ⁵ / ₈ [‡]
# of Doors	1	2	2	2	3
# of Shelves (Size (L x D) (in.))	1 (22 ¹ / ₂ x 17)	2 (15 x 17)	2 (21 x 17)	2 (27 x 17)	3 (21 x 17 (L/R), 23 x 17 (M))
# of Pan	12	15	18	24	30
Net Weight (lbs.)	206	221	244	321	356
Gross Weight (lbs.)	220	242	264	352	396

Design and specifications subject to change without notice. Most updated spec sheets are available at www.turboairinc.com.

Actual shipping weight may differ due to extra packing materials for product protection.

* Depth does not include 3" for cutting boards and 1" for rear spacers. † Height does not include 5" for caster height. ‡ Height does not include 4-3/4" for caster height.

■ **WARRANTY: 5 Year Parts and Labor Warranty, 7 Year Compressor Warranty**

SANDWICH/SALAD UNITS - FRONT BREATHING AIRFLOW/CLEAR LID

■ **Digital temperature control & monitor system**

Keeps food products safe by maintaining constant temperatures. External digital display allows for easy monitoring.

■ **Hydrocarbon refrigerants (R-600a)**

With innovative and eco-friendly technology, Turbo Air brings you hydrocarbon refrigerators designed to meet DOE's Energy Conservation Standards in 2017 and to use EPA's SNAP Program approved HC refrigerants. Hydrocarbon refrigerants do not deplete the ozone layer and have very low contribution to global warming (ODP-0, GWP-3).

■ **Front Breathing airflow**

Front Breathing airflow is designed to draw in air and discharge from the front, allowing units to run at high efficiency in tight spaces and eliminates the need for surrounding clearances.

■ **Cold Bunker system**

Our innovative forced air system allows cold air to flow all around the food pan area, covering not only underneath the pan, but also the front, top and the rear. This unique air flow creates a cold air-shield around the pan, which maintains the food temperature at under 41°F (NSF requirement) even when the lids are opened. In addition, the compartment isolates pans from the reach-in area to prevent food spillage.

■ **Stainless steel exterior**

The Turbo Air M3 model boasts a stainless steel exterior (galvanized steel back and bottom). Interior is AL cabinet with stainless steel floor and ABS door liner. It guarantees the utmost in cleanliness and long product life. The M3 model adds a touch of style to the most refined setting.

■ **High-density polyurethane insulation**

The entire cabinet structure and solid doors are foamed-in-place using high density, CFC free polyurethane insulation.

■ **Ergonomically designed doors**

Customers' fatigue fades away with easy grip handles and doors that open effortlessly. These features along with self-closing doors make this the ultimate choice in customer convenience. ABS sheet door liners resist water condensation with thermal efficiency.

■ **9-1/2" deep, 1/2" thick high-density Polyethylene cutting board included with convenient side rail**

■ **Adjustable, heavy duty, PE (polyethylene) coated wire shelves**



MST-24S-N6

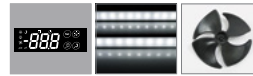

LED interior lighting & fan control

Energy efficient LED lighting lights every corner, making items easy to find. Fan control function automatically shuts off the fan when the door is open, which prevents hot air from being drawn in, thus maintaining the cool inner temperature.

■ **Refrigerator holds 33°F ~ 39°F for the best in food preservation**

■ **Standard features**

- Anti-corrosion coated evaporator
- Self-contained system
- 3" dia. swivel casters with locks on the front set
- 1/6 size, 4" deep condiment pans included
- High-density polyurethane insulation
- Lead time applies (8~10 weeks)

■ **Optional features**

- Legs available for all models: 6"
- Door locks available (extra lead time will apply)
- Casters available for all models: 2.5", 5"

MST MODELS SPECIFICATIONS

ELECTRICAL DATA		MST-24S-N6
Voltage		115/60/1
Plug Type		Ⓢ NEMA 5-15P
Full Load Amp.		2.6
Compressor HP		1/5
Cord Length (ft.)		9
Refrigerant		R-600a
DIMENSIONAL DATA		
Net Capacity (cu. ft.)		2.83
Ext. Dimension (L x D x H†) (in.)		24 x 23 ⁵ / ₈ x 28 ¹ / ₈
# of Doors		1
# of Shelves (Size (L x D) (in.))		1 (19 ³ / ₈ x 11 ¹ / ₈)
# of Pan		6
Net Weight (lbs.)		126
Gross Weight (lbs.)		137

Design and specifications subject to change without notice. Most updated spec sheets are available at www.turboairinc.com.

Actual shipping weight may differ due to extra packing materials for product protection.

* Depth does not include 3-3/8" for cutting board and 1" for rear spacers. † Height does not include 3-7/8" for caster height.

■ **WARRANTY: 5 Year Parts and Labor Warranty, 7 Year Compressor Warranty**

SANDWICH/SALAD UNITS NATURAL Refrigerant

- Digital temperature control & monitor system**
Keeps food products safe by maintaining constant temperatures. External digital display allows for easy monitoring.
- Hydrocarbon refrigerants (R-290)**
With innovative and eco-friendly technology, Turbo Air brings you hydrocarbon refrigerators designed to meet DOE's Energy Conservation Standards in 2017 and to use EPA's SNAP Program approved HC refrigerants. Hydrocarbon refrigerants do not deplete the ozone layer and have very low contribution to global warming (ODP-0, GWP-3).
- Stainless steel exterior**
The Turbo Air J series boasts a stainless steel exterior (galvanized steel back and bottom). Interior is stainless steel floor with AL sides, back and AL door liners. It guarantees the utmost in cleanliness and long product life. The J series adds a touch of style to the most refined setting.
- Side mount compressor unit**
With compressors positioned on the side of the unit, our refrigerators can now be serviced without being moved. Our front air intake feature also allows this model to be highly efficient in narrow spaces.
- Ergonomically designed doors**
Customers' fatigue fades away with easy grip handles and doors that open effortlessly. These features along with self-closing doors make this the ultimate choice in customer convenience.
- Easy open front grille with condenser cleaning brush kit**
Front grille cover is easily removable without any tools, which makes condenser cleaning easy and convenient at any time. Handy condenser cleaning brush is included inside the front grille cover.
- 9-1/2" deep, 1/2" thick high-density Polyethylene cutting board included with convenient side rail**
- Adjustable, heavy duty, PE (polyethylene) coated wire shelves**
- Refrigerator holds 33°F ~ 39°F for the best in food preservation**
- Standard features**

 - Anti-corrosion coated evaporator
 - Self-contained system
 - 4" dia. swivel casters with locks on the front set
 - 1/6 size, 4" deep condiment pans included
 - High-density polyurethane insulation

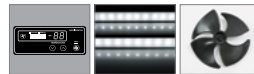

LED interior lighting & fan control
Energy efficient LED lighting lights every corner, making items easy to find. Fan control function automatically shuts off the fan when the door is open, which prevents hot air from being drawn in, thus maintaining the cool inner temperature.

- Optional features**

 - Door locks available (extra lead time will apply)
 - Legs available for all models: 6"
 - Casters available for all models: 1", 2.5", 5"

JST MODELS SPECIFICATIONS

ELECTRICAL DATA	JST-36-N	JST-48-N	JST-60-N	JST-72-N
Voltage	115/60/1	115/60/1	115/60/1	115/60/1
Plug Type	Ⓢ NEMA 5-15P	Ⓢ NEMA 5-15P	Ⓢ NEMA 5-15P	Ⓢ NEMA 5-15P
Full Load Amp.	2.4	3.2	3.5	3.2
Compressor HP	1/3	1/3	2/5	2/5
Cord Length (ft.)	9	9	9	9
Refrigerant	R-290	R-290	R-290	R-290
DIMENSIONAL DATA				
Net Capacity (cu. ft.)	7.5	11	15	18
Ext. Dimension (L x D [†] x H [†]) (in.)	35 ³ / ₈ x 27 ¹ / ₂ x 35 ⁷ / ₈	47 ¹ / ₄ x 27 ¹ / ₂ x 35 ⁷ / ₈	59 x 27 ¹ / ₂ x 35 ⁷ / ₈	70 ⁷ / ₈ x 27 ¹ / ₂ x 35 ⁷ / ₈
# of Doors	1	2	2	3
# of Shelves (Size (L x D) (in.))	1 (19 ¹ / ₂ x 17 ³ / ₄)	2 (15 ³ / ₄ x 17 ³ / ₄)	2 (21 ¹ / ₂ x 17 ³ / ₄)	3 (17 ¹ / ₄ x 17 ³ / ₄ (L/R), 19 ¹ / ₂ x 17 ³ / ₄ (M))
# of Pan	8	12	14	18
Net Weight (lbs.)	157	191	213	254
Gross Weight (lbs.)	177	212	231	275

Design and specifications subject to change without notice. Most updated spec sheets are available at www.turboairinc.com.

Actual shipping weight may differ due to extra packing materials for product protection.

* Depth does not include 1-1/2" for cutting boards and 1" for rear spacers. † Height does not include 4-3/4" for caster height.

- WARRANTY: 2 Year Parts and Labor Warranty, 5 Year Compressor Warranty**

BUFFET DISPLAY TABLES NATURAL Refrigerant

■ **Digital temperature control & monitor system**

Keeps food products safe by maintaining constant temperatures. External digital display allows for easy monitoring.

■ **Hydrocarbon refrigerants (R-290)**

With innovative and eco-friendly technology, Turbo Air brings you hydrocarbon refrigerators designed to meet DOE's Energy Conservation Standards in 2017 and to use EPA's SNAP Program approved HC refrigerants. Hydrocarbon refrigerants do not deplete the ozone layer and have very low contribution to global warming (ODP-0, GWP-3).

■ **Stainless steel exterior**

The Turbo Air J series boasts all stainless steel exterior including back (galvanized steel bottom). Interior is stainless steel floor with AL sides, back and AL door liners. It guarantees the utmost in cleanliness and long product life. The J series adds a touch of style to the most refined setting.

■ **Side mount compressor unit**

With compressors positioned on the side of the unit, our refrigerators can now be serviced without being moved. Our front air intake feature also allows this model to be highly efficient in narrow spaces.

■ **High-density polyurethane insulation**

The entire cabinet structure and solid doors are foamed-in-place using high density, CFC free polyurethane insulation.

■ **Ergonomically designed doors**

Customers' fatigue fades away with easy grip handles and doors that open effortlessly. These features along with self-closing doors make this the ultimate choice in customer convenience.

■ **Easy open front grille with condenser cleaning brush kit**

Front grille cover is easily removable without any tools, which makes condenser cleaning easy and convenient at any time. Handy condenser cleaning brush is included inside the front grille cover.

■ **Adjustable, heavy duty, PE (polyethylene) coated wire shelves**

■ **Double sided polycarbonate sneeze guard (optional)**

The transparent polycarbonate cover is durable, and the two 304 stainless steel side stands are easy to clean and anticorrosive.

■ **Refrigerator holds 33°F ~ 39°F for the best in food preservation**



JBT-60-N
* Sneeze guard not included (optional)

JBT-36-N

■ **Standard features**

- Anti-corrosion coated evaporator
- Self-contained system
- 4" dia. swivel casters with locks on the front set
- 1/3 size condiment pan included

■ **Optional features**

- Door locks available (extra lead time will apply)
- Legs available for all models: 6"
- Sneeze guard available
- Tray slide available
- Clear pan cover available
- Casters available for all models: 1", 2.5", 5"

JBT MODELS SPECIFICATIONS

ELECTRICAL DATA	JBT-36-N	JBT-48-N	JBT-60-N	JBT-72-N
Voltage	115/60/1	115/60/1	115/60/1	115/60/1
Plug Type	Ⓜ NEMA 5-15P	Ⓜ NEMA 5-15P	Ⓜ NEMA 5-15P	Ⓜ NEMA 5-15P
Full Load Amp.	3.2	3.8	6.2	6.1
Compressor HP	2/5	2/5	1/2	1/2
Cord Length (ft.)	9	9	9	9
Refrigerant	R-290	R-290	R-290	R-290
DIMENSIONAL DATA				
Net Capacity (cu. ft.)	7.5	11	15	18
Ext. Dimension (L x D x H†) (in.)	35 ³ / ₈ x 27 ¹ / ₂ x 29	47 ¹ / ₄ x 27 ¹ / ₂ x 29	59 x 27 ¹ / ₂ x 29	70 ⁷ / ₈ x 27 ¹ / ₂ x 29
# of Doors	1	2	2	3
# of Shelves (Size (L x D) (in.))	1 (19 ¹ / ₂ x 17 ³ / ₄)	2 (15 ³ / ₄ x 17 ³ / ₄)	2 (21 ¹ / ₂ x 17 ³ / ₄)	3 (17 ¹ / ₄ x 17 ³ / ₄ (L/R), 19 ¹ / ₂ x 17 ³ / ₄ (M))
# of Pan	6	9	12	15
Net Weight (lbs.)	152	179	200	234
Gross Weight (lbs.)	171	200	235	279

Design and specifications subject to change without notice. Most updated spec sheets are available at www.turboairinc.com.

Actual shipping weight may differ due to extra packing materials for product protection.

† Height does not include 4-3/4" for caster height.

■ **WARRANTY: 2 Year Parts and Labor Warranty, 5 Year Compressor Warranty**

COUNTERTOP SALAD TABLES NATURAL Refrigerant

■ **Hydrocarbon refrigerants (R-290)**

With innovative and eco-friendly technology, Turbo Air brings you hydrocarbon refrigerators designed to meet DOE's Energy Conservation Standards in 2017 and to use EPA's SNAP Program approved HC refrigerants. Hydrocarbon refrigerants do not deplete the ozone layer and have very low contribution to global warming (ODP-0, GWP-3).

■ **Digital temperature display on front panel**

Keeps food products safe by maintaining constant temperatures. External digital display allows for easy monitoring.

■ **Stainless steel cabinet construction**

The Turbo Air model boasts a stainless steel interior and exterior. It guarantees the utmost in cleanliness and long product life. The countertop salad table adds a touch of style to the most refined setting.

■ **Side mount compressor makes it easy to be serviced without being moved**

■ **High-density polyurethane insulation**

The entire cabinet structure and solid doors are foamed-in-place using high density, CFC free polyurethane insulation.

■ **Easy cleaning and excellent durability**

■ **Static cooling system**

■ **Stainless steel lids**

■ **On/off Power switch easily accessible**

■ **Refrigerator holds 32°F ~ 41°F for the best in food preservation**

■ **Accommodates standard GN 1/4 size, 6" deep condiment pans (pans not included)**

■ **Standard features**

- Self-contained system
- ABS legs
- Lead time applies

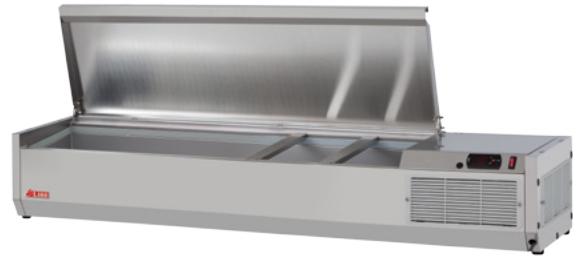

CTST-1200-N



CTST-1500-N



CTST-1800-N

CTST MODELS SPECIFICATIONS

ELECTRICAL DATA	CTST-1200-N	CTST-1500-N	CTST-1800-N
Voltage	115/60/1	115/60/1	115/60/1
Plug Type	Ⓢ NEMA 5-15P	Ⓢ NEMA 5-15P	Ⓢ NEMA 5-15P
Full Load Amp.	1.3	1.3	1.3
Compressor HP	1/6	1/6	1/6
Cord Length (ft.)	9	9	9
Refrigerant	R-290	R-290	R-290
DIMENSIONAL DATA			
Ext. Dimension (L x D x H*) (in.)	48 3/8 x 13 1/4 x 9 3/4	60 1/4 x 13 1/4 x 9 3/4	72 x 13 1/4 x 9 3/4
# of Pans	5	7	9
Pan Dimension (in.)	10 3/8 x 6 3/8 x 6	10 3/8 x 6 3/8 x 6	10 3/8 x 6 3/8 x 6
# of Pan Guide	2 (10 1/2 x 1 5/8)	2 (10 1/2 x 1 1/8)	-
Net Weight (lbs.)	55	64	73
Gross Weight (lbs.)	62	70	79

Design and specifications subject to change without notice. Most updated spec sheets are available at www.turboairinc.com.

Actual shipping weight may differ due to extra packing materials for product protection.

* Height does not include 3/8" for leg height.

■ **WARRANTY: 2 Year Parts and Labor Warranty, 5 Year Compressor Warranty**

COUNTERTOP SALAD TABLES NATURAL Refrigerant

■ **Hydrocarbon refrigerants (R-290)**

With innovative and eco-friendly technology, Turbo Air brings you hydrocarbon refrigerators designed to meet DOE's Energy Conservation Standards in 2017 and to use EPA's SNAP Program approved HC refrigerants. Hydrocarbon refrigerants do not deplete the ozone layer and have very low contribution to global warming (ODP-0, GWP-3).

■ **Digital temperature display on front panel**

Keeps food products safe by maintaining constant temperatures. External digital display allows for easy monitoring.

■ **Stainless steel cabinet construction**

The Turbo Air model boasts a stainless steel interior and exterior. It guarantees the utmost in cleanliness and long product life. The countertop salad table adds a touch of style to the most refined setting.

■ **Side mount compressor makes it easy to be serviced without being moved**

■ **High-density polyurethane insulation**

The entire cabinet structure and solid doors are foamed-in-place using high density, CFC free polyurethane insulation.

■ **Easy cleaning and excellent durability**

■ **Static cooling system**

■ **Stainless steel lids**

■ **On/off Power switch easily accessible**

■ **Refrigerator holds 32°F ~ 41°F for the best in food preservation**

■ **Accommodates standard GN 1/4 size, 6" deep condiment pans (pans not included)**

■ **Standard features**

- Self-contained system
- ABS legs
- Lead time applies



CTST-1200-13-N



CTST-1500-13-N

CTST MODELS SPECIFICATIONS

ELECTRICAL DATA		CTST-1200-13-N	CTST-1500-13-N	CTST-1800-13-N
Voltage		115/60/1	115/60/1	115/60/1
Plug Type		ⓘ NEMA 5-15P	ⓘ NEMA 5-15P	ⓘ NEMA 5-15P
Full Load Amp.		2	2	2
Compressor HP		1/6	1/6	1/6
Cord Length (ft.)		9	9	9
Refrigerant		R-290	R-290	R-290
DIMENSIONAL DATA				
Ext. Dimension (L x D x H*) (in.)		47 1/4 x 15 1/2 x 9 7/8	59 x 15 1/2 x 9 7/8	70 7/8 x 15 1/2 x 9 7/8
Pan Dimension (L x W) (in.) (# of Pans)	1/6	6 7/8 x 6 3/8 (8)	6 7/8 x 6 3/8 (12)	6 7/8 x 6 3/8 (16)
	1/3	12 3/4 x 6 7/8 (4)	12 3/4 x 6 7/8 (6)	12 3/4 x 6 7/8 (8)
# of Pan Guide		1 (13 x 3 1/2), 2 (13 x 1 3/8)	3 (13 x 1 3/8)	-
Net Weight (lbs.)		68	77	86
Gross Weight (lbs.)		75	84	93

Design and specifications subject to change without notice. Most updated spec sheets are available at www.turboairinc.com.

Actual shipping weight may differ due to extra packing materials for product protection.

* Height does not include 3/8" for leg height.

■ **WARRANTY: 2 Year Parts and Labor Warranty, 5 Year Compressor Warranty**

COUNTERTOP SALAD TABLES - CLEAR HOOD NATURAL Refrigerant

■ **Hydrocarbon refrigerants (R-290)**

With innovative and eco-friendly technology, Turbo Air brings you hydrocarbon refrigerators designed to meet DOE's Energy Conservation Standards in 2017 and to use EPA's SNAP Program approved HC refrigerants. Hydrocarbon refrigerants do not deplete the ozone layer and have very low contribution to global warming (ODP-0, GWP-3).

■ **Digital temperature display on front panel**

Keeps food products safe by maintaining constant temperatures. External digital display allows for easy monitoring.

■ **Stainless steel cabinet construction**

The Turbo Air model boasts a stainless steel interior and exterior. It guarantees the utmost in cleanliness and long product life. The countertop salad table adds a touch of style to the most refined setting.

■ **Side mount compressor makes it easy to be serviced without being moved**

■ **High-density polyurethane insulation**

The entire cabinet structure and solid doors are foamed-in-place using high density, CFC free polyurethane insulation.

■ **Easy cleaning and excellent durability**

■ **Static cooling system**

■ **On/off Power switch easily accessible**

■ **Refrigerator holds 32°F ~ 41°F for the best in food preservation**

■ **Accommodates standard GN 1/4 size, 6" deep condiment pans (pans not included)**

■ **Standard features**

- Self-contained system
- ABS legs
- Lead time applies



CTST-1200G-N



CTST-1500G-N



CTST-1800G-N

CTST MODELS SPECIFICATIONS

ELECTRICAL DATA	CTST-1200G-N	CTST-1500G-N	CTST-1800G-N
Voltage	115/60/1	115/60/1	115/60/1
Plug Type	Ⓜ NEMA 5-15P	Ⓜ NEMA 5-15P	Ⓜ NEMA 5-15P
Full Load Amp.	1.3	1.3	1.3
Compressor HP	1/6	1/6	1/6
Cord Length (ft.)	9	9	9
Refrigerant	R-290	R-290	R-290
DIMENSIONAL DATA			
Ext. Dimension (L x D x H*) (in.)	48 ³ / ₈ x 13 ¹ / ₄ x 16 ³ / ₄	60 ¹ / ₄ x 13 ¹ / ₄ x 16 ³ / ₄	72 x 13 ¹ / ₄ x 16 ³ / ₄
# of Pans	5	7	9
Pan Dimension (in.)	10 ³ / ₈ x 6 ³ / ₈ x 6	10 ³ / ₈ x 6 ³ / ₈ x 6	10 ³ / ₈ x 6 ³ / ₈ x 6
# of Pan Guide	2 (10 ¹ / ₂ x 1 ⁵ / ₈)	2 (10 ¹ / ₂ x 1 ¹ / ₈)	-
Net Weight (lbs.)	59	70	81
Gross Weight (lbs.)	66	77	88

Design and specifications subject to change without notice. Most updated spec sheets are available at www.turboairinc.com.

Actual shipping weight may differ due to extra packing materials for product protection.

* Height does not include 3/8" for leg height.

■ **WARRANTY: 2 Year Parts and Labor Warranty, 5 Year Compressor Warranty**

COUNTERTOP SALAD TABLES - CLEAR HOOD NATURAL Refrigerant

■ **Hydrocarbon refrigerants (R-290)**

With innovative and eco-friendly technology, Turbo Air brings you hydrocarbon refrigerators designed to meet DOE's Energy Conservation Standards in 2017 and to use EPA's SNAP Program approved HC refrigerants. Hydrocarbon refrigerants do not deplete the ozone layer and have very low contribution to global warming (ODP-0, GWP-3).

■ **Digital temperature display on front panel**

Keeps food products safe by maintaining constant temperatures. External digital display allows for easy monitoring.

■ **Stainless steel cabinet construction**

The Turbo Air model boasts a stainless steel interior and exterior. It guarantees the utmost in cleanliness and long product life. The countertop salad table adds a touch of style to the most refined setting.

■ **Side mount compressor makes it easy to be serviced without being moved**

■ **High-density polyurethane insulation**

The entire cabinet structure and solid doors are foamed-in-place using high density, CFC free polyurethane insulation.

■ **Easy cleaning and excellent durability**

■ **Static cooling system**

■ **On/off Power switch easily accessible**

■ **Refrigerator holds 32°F ~ 41°F for the best in food preservation**

■ **Accommodates standard GN 1/4 size, 6" deep condiment pans (pans not included)**

■ **Standard features**

- Self-contained system
- ABS legs
- Lead time applies



CTST-1200G-13-N



CTST-1500G-13-N



CTST-1800G-13-N

CTST MODELS SPECIFICATIONS

ELECTRICAL DATA	CTST-1200G-13-N	CTST-1500G-13-N	CTST-1800G-13-N
Voltage	115/60/1	115/60/1	115/60/1
Plug Type	Ⓜ NEMA 5-15P	Ⓜ NEMA 5-15P	Ⓜ NEMA 5-15P
Full Load Amp.	2	2	2
Compressor HP	1/6	1/6	1/6
Cord Length (ft.)	9	9	9
Refrigerant	R-290	R-290	R-290
DIMENSIONAL DATA			
Ext. Dimension (L x D x H*) (in.)	47 1/4 x 15 1/2 x 16 3/4	59 x 15 1/2 x 16 3/4	70 7/8 x 15 1/2 x 16 3/4
Pan Dimension (L x W) (in.) (# of Pans)	1/6	6 7/8 x 6 3/8 (8)	6 7/8 x 6 3/8 (16)
	1/3	12 3/4 x 6 7/8 (4)	12 3/4 x 6 7/8 (8)
# of Pan Guide	1 (13 x 3 1/2), 2 (13 x 1 3/8)	3 (13 x 1 3/8)	-
Net Weight (lbs.)	73	84	95
Gross Weight (lbs.)	79	90	101

Design and specifications subject to change without notice. Most updated spec sheets are available at www.turboairinc.com.

Actual shipping weight may differ due to extra packing materials for product protection.

* Height does not include 3/8" for leg height.

■ **WARRANTY: 2 Year Parts and Labor Warranty, 5 Year Compressor Warranty**



Undercounters Worktops Chef Bases

Undercounter Refrigerators & Freezers

PRO Series

Solid / Glass Doors / Drawers
Front Breathing Airflow - Solid Doors / Drawers

Super Deluxe Series

Solid Doors / Drawers
Front Breathing Airflow - Solid Doors / Drawers

M3 Series

Solid Doors / Low Boy / Shallow Depth

J Series

Solid Doors / Narrow Depth / Extra Deep
Glass Doors / Dual Temp.

Worktop Refrigerators & Freezers

PRO Series

Solid Doors / Glass Doors / Drawers
Front Breathing Airflow - Solid Doors / Drawers

Super Deluxe Series

Solid Doors / Drawers
Front Breathing Airflow - Solid Doors / Drawers

M3 Series

Solid Doors - Shallow Depth

Chef Bases

PRO Series

Regular

Super Deluxe Series

Regular / Extended Top

UNDERCOUNTER REFRIGERATORS NATURAL Refrigerant

Self-Cleaning Condenser Equipped Units

■ **Self-Cleaning Condenser (Patented)**

The accumulation of dust in the condenser can cause the failure or breakdown of refrigerators. Refrigerators run normally until they reach a certain level of accumulation. At some point, when they are over the limit, their performance drops quickly resulting in damage to, or disposal of the stored products inside. The Self-Cleaning Condenser device keeps the condenser clean and prevents system failure by automatically brushing daily.

■ **Digital temperature control & monitor system**

Keeps food products safe by maintaining constant temperatures. External digital display allows for easy monitoring.

■ **Hydrocarbon refrigerants (R-290)**

With innovative and eco-friendly technology, Turbo Air brings you hydrocarbon refrigerators designed to meet DOE's Energy Conservation Standards in 2017 and to use EPA's SNAP Program approved HC refrigerants. Hydrocarbon refrigerants do not deplete the ozone layer and have very low contribution to global warming (ODP-0, GWP-3).

■ **Stainless steel cabinet construction**

The PRO series model boasts a stainless steel interior and a 22 gauge stainless steel exterior (galvanized steel bottom). It guarantees the utmost in cleanliness and long product life. The PRO series adds a touch of style to the most refined setting.

■ **Sturdy, clean stainless steel shelving**

Shelves are the most important part of cleanliness as they come in direct contact with food. The PRO series uniquely provides stainless steel shelving.

■ **Ergonomically designed doors**

Customers' fatigue fades away with easy grip handles and doors that open effortlessly. These features along with self-closing doors make this the ultimate choice in customer convenience.

■ **High-density polyurethane insulation**

The entire cabinet structure and solid doors are foamed-in-place using high density, CFC free polyurethane insulation.

■ **Left hinged (PUR-28-N-L), all left hinged (PUR-48-N-AL, PUR-72-N-AL) and all right hinged (PUR-48-N-AR) models available**

■ **Spring assisted heavy duty gravity hinge**

■ **Refrigerator holds 33°F ~ 38°F for the best in food preservation**



PUR-72-N



PUR-48-N

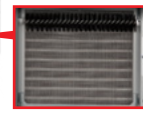

Self-Cleaning Condenser
Maintenance-free during warranty period

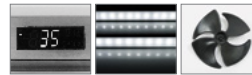

LED interior lighting & fan control

Energy efficient LED lighting lights every corner, making items easy to find. Fan control function automatically shuts off the fan when the door is open, which prevents hot air from being drawn in, thus maintaining the cool inner temperature.

■ **Standard features**

- Anti-corrosion coated evaporator
- Self-contained system
- 4" dia. swivel casters with locks on the front set
- Door locks
- Lead time applies

■ **Optional features**

- Legs available for all models: 6"
- Stainless steel single/double overshef available (except PUR-28-N)
- Casters available for all models: 1" (1.5" low profile caster kit for PUR-28-N), 2.5" (except PUR-28-N), 5"
- Stacking kit for PUR-28-N available

PUR MODELS SPECIFICATIONS

ELECTRICAL DATA	PUR-28-N	PUR-48-N	PUR-60-N	PUR-72-N
Voltage	115/60/1	115/60/1	115/60/1	115/60/1
Plug Type	Ⓜ NEMA 5-15P	Ⓜ NEMA 5-15P	Ⓜ NEMA 5-15P	Ⓜ NEMA 5-15P
Full Load Amp.	6.6	6.5	8.9	9.9
Compressor HP	1/6	1/6	1/6	1/6
Cord Length (ft.)	10	10	10	10
Refrigerant	R-290	R-290	R-290	R-290
DIMENSIONAL DATA				
Net Capacity (cu. ft.)	6.8	12.2	15.5	18.8
Ext. Dimension (L x D* x H†) (in.)	27 1/2 x 30 x 30 1/2	48 1/4 x 30 x 30 1/2	60 1/4 x 30 x 30 1/2	72 5/8 x 30 x 30 1/2
# of Doors	1	2	2	2
# of Shelves	1	2	2	2
Shelf Size (L x D) (in.)	22 1/2 x 17	21 x 17	27 x 17	33 1/8 x 17
Net Weight (lbs.)	153	235	255	318
Gross Weight (lbs.)	163	246	282	352

Design and specifications subject to change without notice. Most updated spec sheets are available at www.turboairinc.com.

Actual shipping weight may differ due to extra packing materials for product protection.

* Depth does not include 2" for door handles and rear spacers. † Height does not include 4-1/2" for caster height.

■ **WARRANTY: 5 Year Parts and Labor Warranty, 7 Year Compressor Warranty**

GLASS DOOR UNDERCOUNTER REF. NATURAL Refrigerant

Self-Cleaning Condenser Equipped Units

■ **Self-Cleaning Condenser (Patented)**

The accumulation of dust in the condenser can cause the failure or breakdown of refrigerators. Refrigerators run normally until they reach a certain level of accumulation. At some point, when they are over the limit, their performance drops quickly resulting in damage to, or disposal of the stored products inside. The Self-Cleaning Condenser device keeps the condenser clean and prevents system failure by automatically brushing daily.

■ **Digital temperature control & monitor system**

Keeps food products safe by maintaining constant temperatures. External digital display allows for easy monitoring.

■ **Hydrocarbon refrigerants (R-290)**

With innovative and eco-friendly technology, Turbo Air brings you hydrocarbon refrigerators designed to meet DOE's Energy Conservation Standards in 2017 and to use EPA's SNAP Program approved HC refrigerants. Hydrocarbon refrigerants do not deplete the ozone layer and have very low contribution to global warming (ODP-0, GWP-3).

■ **Stainless steel cabinet construction**

The PRO series model boasts a stainless steel interior and a **22 gauge** stainless steel exterior (galvanized steel bottom). It guarantees the utmost in cleanliness and long product life. The PRO series adds a touch of style to the most refined setting.

■ **Sturdy, clean stainless steel shelving**

Shelves are the most important part of cleanliness as they come in direct contact with food. The PRO series uniquely provides stainless steel shelving.

■ **Ergonomically designed doors**

Customers' fatigue fades away with easy grip handles and doors that open effortlessly. These features along with self-closing doors make this the ultimate choice in customer convenience.

■ **High-density polyurethane insulation**

The entire cabinet structure and solid doors are foamed-in-place using high density, CFC free polyurethane insulation.

■ **Left hinged model available (PUR-28-G-N-L)**

■ **Spring assisted heavy duty gravity hinge**

■ **Refrigerator holds 33°F ~ 38°F for the best in food preservation**

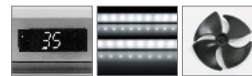

LED interior lighting & fan control

Energy efficient LED lighting lights every corner, making items easy to find. Fan control function automatically shuts off the fan when the door is open, which prevents hot air from being drawn in, thus maintaining the cool inner temperature.

■ **Standard features**

- Anti-corrosion coated evaporator
- Self-contained system
- 4" dia. swivel casters with locks on the front set
- Door locks
- Lead time applies

■ **Optional features**

- Legs available for all models: 6"
- Stainless steel single/double overshelf available (except PUR-28-G-N)
- Casters available for all models: 1" (1.5" low profile caster kit for PUR-28-G-N), 2.5" (except PUR-28-G-N), 5"
- Stacking kit for PUR-28-G-N available

PUR-G MODELS SPECIFICATIONS

ELECTRICAL DATA	PUR-28-G-N	PUR-48-G-N	PUR-60-G-N	PUR-72-G-N
Voltage	115/60/1	115/60/1	115/60/1	115/60/1
Plug Type	Ⓜ NEMA 5-15P	Ⓜ NEMA 5-15P	Ⓜ NEMA 5-15P	Ⓜ NEMA 5-15P
Full Load Amp.	6.6	6.5	8.9	9.9
Compressor HP	1/6	1/6	1/6	1/6
Cord Length (ft.)	10	10	10	10
Refrigerant	R-290	R-290	R-290	R-290
DIMENSIONAL DATA				
Net Capacity (cu. ft.)	6.8	12.2	17	18.8
Ext. Dimension (L x D [†] x H [†]) (in.)	27 ^{1/2} x 30 x 30 ^{1/2}	48 ^{1/4} x 30 x 30 ^{1/2}	60 ^{1/4} x 30 x 30 ^{1/2}	72 ^{5/8} x 30 x 30 ^{1/2}
# of Doors	1	2	2	2
# of Shelves	1	2	2	2
Shelf Size (L x D) (in.)	22 ^{1/2} x 17	21 x 17	27 x 17	33 ^{1/8} x 17
Net Weight (lbs.)	161	248	265	325
Gross Weight (lbs.)	171	260	290	358

Design and specifications subject to change without notice. Most updated spec sheets are available at www.turboairinc.com.

Actual shipping weight may differ due to extra packing materials for product protection.

* Depth does not include 2" for door handles and rear spacers. † Height does not include 4-1/2" for caster height.

■ **WARRANTY: 5 Year Parts and Labor Warranty, 7 Year Compressor Warranty**

UNDERCOUNTER REFRIGERATORS - DRAWERS NATURAL Refrigerant

Self-Cleaning Condenser Equipped Units

■ **Self-Cleaning Condenser (Patented)**

The accumulation of dust in the condenser can cause the failure or breakdown of refrigerators. Refrigerators run normally until they reach a certain level of accumulation. At some point, when they are over the limit, their performance drops quickly resulting in damage to, or disposal of the stored products inside. The Self-Cleaning Condenser device keeps the condenser clean and prevents system failure by automatically brushing daily.

■ **Digital temperature control & monitor system**

Keeps food products safe by maintaining constant temperatures. External digital display allows for easy monitoring.

■ **Hydrocarbon refrigerants (R-290)**

With innovative and eco-friendly technology, Turbo Air brings you hydrocarbon refrigerators designed to meet DOE's Energy Conservation Standards in 2017 and to use EPA's SNAP Program approved HC refrigerants. Hydrocarbon refrigerants do not deplete the ozone layer and have very low contribution to global warming (ODP-0, GWP-3).

■ **Stainless steel cabinet construction**

The PRO series model boasts a stainless steel interior and a **22 gauge** stainless steel exterior (galvanized steel bottom). It guarantees the utmost in cleanliness and long product life. The PRO series adds a touch of style to the most refined setting.

■ **Sturdy, clean stainless steel shelving**

Shelves are the most important part of cleanliness as they come in direct contact with food. The PRO series uniquely provides stainless steel shelving (only PUR-48-D2R(L)-N).

■ **Ergonomically designed doors**

Customers' fatigue fades away with easy grip handles and doors that open effortlessly. These features along with self-closing doors make this the ultimate choice in customer convenience (only PUR-48-D2R(L)-N).

■ **High-density polyurethane insulation**

The entire cabinet structure and solid doors are foamed-in-place using high density, CFC free polyurethane insulation.

■ **Spring assisted heavy duty gravity hinge**

(only PUR-48-D2R(L)-N)

■ **Refrigerator holds 33°F ~ 38°F for the best in food preservation**

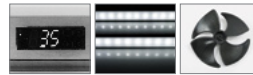

LED interior lighting & fan control

Energy efficient LED lighting lights every corner, making items easy to find. Fan control function automatically shuts off the fan when the door is open, which prevents hot air from being drawn in, thus maintaining the cool inner temperature (only PUR-48-D2R(L)-N).

■ **Standard features**

- Anti-corrosion coated evaporator
- Self-contained system
- 4" dia. swivel casters with locks on the front set
- Door locks (only PUR-48-D2R(L)-N)
- Lead time applies

■ **Optional features**

- Legs available for all models: 6"
- Stainless steel single/double overshef available (except PUR-28-D2-N)
- Casters available for all models: 1" (1.5" low profile caster kit for PUR-28-D2-N), 2.5" (except PUR-28-D2-N), 5"
- Stacking kit for PUR-28-D2-N available

PUR MODELS SPECIFICATIONS

ELECTRICAL DATA	PUR-28-D2-N	PUR-48-D2R(L)-N	PUR-48-D4-N
Voltage	115/60/1	115/60/1	115/60/1
Plug Type	Ⓜ NEMA 5-15P	Ⓜ NEMA 5-15P	Ⓜ NEMA 5-15P
Full Load Amp.	6.6	6.5	6.5
Compressor HP	1/6	1/6	1/6
Cord Length (ft.)	10	10	10
Refrigerant	R-290	R-290	R-290
DIMENSIONAL DATA			
Net Capacity (cu. ft.)	6.8	12.2	12.2
Ext. Dimension (L x D [*] x H [†]) (in.)	27 ¹ / ₂ x 30 x 30 ¹ / ₂	48 ¹ / ₄ x 30 x 30 ¹ / ₂	48 ¹ / ₄ x 30 x 30 ¹ / ₂
# of Doors	-	1	-
# of Drawers	2	2	4
# of Shelves	-	1	-
Shelf Size (L x D) (in.)	-	21 x 17	-
Net Weight (lbs.)	159	240	245
Gross Weight (lbs.)	175	259	267

Design and specifications subject to change without notice. Most updated spec sheets are available at www.turboairinc.com.

Actual shipping weight may differ due to extra packing materials for product protection.

* Depth does not include 2" for door handles and rear spacers. † Height does not include 4-1/2" for caster height.

■ **WARRANTY: 5 Year Parts and Labor Warranty, 7 Year Compressor Warranty**

UNDERCOUNTER REFRIGERATORS - DRAWERS NATURAL Refrigerant

Self-Cleaning Condenser Equipped Units

■ **Self-Cleaning Condenser (Patented)**

The accumulation of dust in the condenser can cause the failure or breakdown of refrigerators. Refrigerators run normally until they reach a certain level of accumulation. At some point, when they are over the limit, their performance drops quickly resulting in damage to, or disposal of the stored products inside. The Self-Cleaning Condenser device keeps the condenser clean and prevents system failure by automatically brushing daily.

■ **Digital temperature control & monitor system**

Keeps food products safe by maintaining constant temperatures. External digital display allows for easy monitoring.

■ **Hydrocarbon refrigerants (R-290)**

With innovative and eco-friendly technology, Turbo Air brings you hydrocarbon refrigerators designed to meet DOE's Energy Conservation Standards in 2017 and to use EPA's SNAP Program approved HC refrigerants. Hydrocarbon refrigerants do not deplete the ozone layer and have very low contribution to global warming (ODP-0, GWP-3).

■ **Stainless steel cabinet construction**

The PRO series model boasts a stainless steel interior and a **22 gauge** stainless steel exterior (galvanized steel bottom). It guarantees the utmost in cleanliness and long product life. The PRO series adds a touch of style to the most refined setting.

■ **Sturdy, clean stainless steel shelving**

Shelves are the most important part of cleanliness as they come in direct contact with food. The PRO series uniquely provides stainless steel shelving (only PUR-60-D2R(L)-N, PUR-72-D2R(L)-N).

■ **Ergonomically designed doors**

Customers' fatigue fades away with easy grip handles and doors that open effortlessly. These features along with self-closing doors make this the ultimate choice in customer convenience (only PUR-60-D2R(L)-N, PUR-72-D2R(L)-N).

■ **High-density polyurethane insulation**

The entire cabinet structure and solid doors are foamed-in-place using high density, CFC free polyurethane insulation.

■ **Spring assisted heavy duty gravity hinge**

(only PUR-60-D2R(L)-N, PUR-72-D2R(L)-N)

■ **Refrigerator holds 33°F ~ 38°F for the best in food preservation**

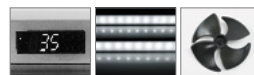

LED interior lighting & fan control

Energy efficient LED lighting lights every corner, making items easy to find. Fan control function automatically shuts off the fan when the door is open, which prevents hot air from being drawn in, thus maintaining the cool inner temperature (only PUR-60-D2R(L)-N, PUR-72-D2R(L)-N).

■ **Standard features**

- Anti-corrosion coated evaporator
- Self-contained system
- 4" dia. swivel casters with locks on the front set
- Door locks (only PUR-60-D2R(L)-N, PUR-72-D2R(L)-N)
- Lead time applies

■ **Optional features**

- Legs available for all models: 6"
- Stainless steel single/double overshef available
- Casters available for all models: 1", 2.5", 5"

PUR MODELS SPECIFICATIONS

ELECTRICAL DATA	PUR-60-D2R(L)-N	PUR-60-D4-N	PUR-72-D2R(L)-N	PUR-72-D4-N
Voltage	115/60/1	115/60/1	115/60/1	115/60/1
Plug Type	Ⓜ NEMA 5-15P	Ⓜ NEMA 5-15P	Ⓜ NEMA 5-15P	Ⓜ NEMA 5-15P
Full Load Amp.	8.9	8.9	9.9	9.9
Compressor HP	1/6	1/6	1/6	1/6
Cord Length (ft.)	10	10	10	10
Refrigerant	R-290	R-290	R-290	R-290
DIMENSIONAL DATA				
Net Capacity (cu. ft.)	15.5	15.5	18.8	18.8
Ext. Dimension (L x D* x H†) (in.)	60 ¹ / ₄ x 30 x 30 ¹ / ₂	60 ¹ / ₄ x 30 x 30 ¹ / ₂	72 ⁵ / ₈ x 30 x 30 ¹ / ₂	72 ⁵ / ₈ x 30 x 30 ¹ / ₂
# of Doors	1	-	1	-
# of Drawers	2	4	2	4
# of Shelves	1	-	1	-
Shelf Size (L x D) (in.)	27 x 17	-	33 ¹ / ₈ x 17	-
Net Weight (lbs.)	265	268	324	327
Gross Weight (lbs.)	293	298	359	362

Design and specifications subject to change without notice. Most updated spec sheets are available at www.turboairinc.com.

Actual shipping weight may differ due to extra packing materials for product protection.

* Depth does not include 2" for door handles and rear spacers. † Height does not include 4-1/2" for caster height.

■ **WARRANTY: 5 Year Parts and Labor Warranty, 7 Year Compressor Warranty**

UNDERCOUNTER FREEZERS NATURAL Refrigerant

Self-Cleaning Condenser Equipped Units

■ **Self-Cleaning Condenser (Patented)**

The accumulation of dust in the condenser can cause the failure or breakdown of refrigerators. Refrigerators run normally until they reach a certain level of accumulation. At some point, when they are over the limit, their performance drops quickly resulting in damage to, or disposal of the stored products inside. The Self-Cleaning Condenser device keeps the condenser clean and prevents system failure by automatically brushing daily.

■ **Digital temperature control & monitor system**

Keeps food products safe by maintaining constant temperatures. External digital display allows for easy monitoring.

■ **Hydrocarbon refrigerants (R-290)**

With innovative and eco-friendly technology, Turbo Air brings you hydrocarbon refrigerators designed to meet DOE's Energy Conservation Standards in 2017 and to use EPA's SNAP Program approved HC refrigerants. Hydrocarbon refrigerants do not deplete the ozone layer and have very low contribution to global warming (ODP-0, GWP-3).

■ **Stainless steel cabinet construction**

The PRO series model boasts a stainless steel interior and a 22 gauge stainless steel exterior (galvanized steel bottom). It guarantees the utmost in cleanliness and long product life. The PRO series adds a touch of style to the most refined setting.

■ **Sturdy, clean stainless steel shelving**

Shelves are the most important part of cleanliness as they come in direct contact with food. The PRO series uniquely provides stainless steel shelving.

■ **Ergonomically designed doors**

Customers' fatigue fades away with easy grip handles and doors that open effortlessly. These features along with self-closing doors make this the ultimate choice in customer convenience.

■ **High-density polyurethane insulation**

The entire cabinet structure and solid doors are foamed-in-place using high density, CFC free polyurethane insulation.

■ **Left hinged model available (PUF-28-N-L)**

■ **Spring assisted heavy duty gravity hinge**

■ **Freezer holds -10°F ~ 0°F for the best in frozen food preservation**

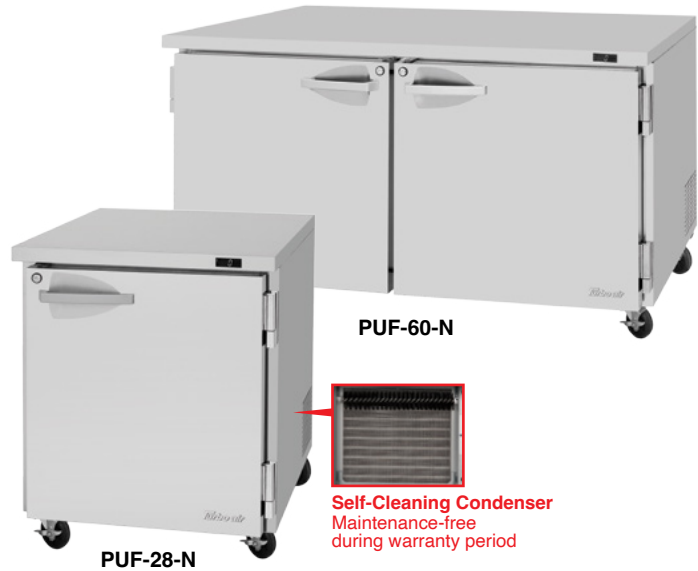

LED interior lighting & fan control

Energy efficient LED lighting lights every corner, making items easy to find. Fan control function automatically shuts off the fan when the door is open, which prevents hot air from being drawn in, thus maintaining the cool inner temperature.

■ **Standard features**

- Anti-corrosion coated evaporator
- Self-contained system
- 4" dia. swivel casters with locks on the front set
- Door locks
- Lead time applies

■ **Optional features**

- Legs available for all models: 6"
- Stainless steel single/double overself available (except PUF-28-N)
- Casters available for all models: 1" (1.5" low profile caster kit for PUF-28-N), 2.5" (except PUF-28-N), 5"
- Stacking kit for PUF-28-N available

PUF MODELS SPECIFICATIONS

ELECTRICAL DATA	PUF-28-N	PUF-48-N	PUF-60-N
Voltage	115/60/1	115/60/1	115/60/1
Plug Type	Ⓜ NEMA 5-15P	Ⓜ NEMA 5-15P	Ⓜ NEMA 5-15P
Full Load Amp.	4.5	8	5.6
Compressor HP	1/4	1/3	1/2
Cord Length (ft.)	10	10	10
Refrigerant	R-290	R-290	R-290
DIMENSIONAL DATA			
Net Capacity (cu. ft.)	6.8	12.2	17.2
Ext. Dimension (L x D* x H†) (in.)	27 1/2 x 30 x 30 1/2	48 1/4 x 30 x 30 1/2	60 1/4 x 30 x 30 1/2
# of Doors	1	2	2
# of Shelves	1	2	2
Shelf Size (L x D) (in.)	22 1/2 x 17	21 x 17	27 x 17
Net Weight (lbs.)	154	235	254
Gross Weight (lbs.)	163	246	282

Design and specifications subject to change without notice. Most updated spec sheets are available at www.turboairinc.com.

Actual shipping weight may differ due to extra packing materials for product protection.

* Depth does not include 2" for door handles and rear spacers. † Height does not include 4-1/2" for caster height.

■ **WARRANTY: 5 Year Parts and Labor Warranty, 7 Year Compressor Warranty**

UNDERCOUNTER FREEZER - DRAWERS NATURAL Refrigerant

Self-Cleaning Condenser Equipped Units

■ **Self-Cleaning Condenser (Patented)**

The accumulation of dust in the condenser can cause the failure or breakdown of refrigerators. Refrigerators run normally until they reach a certain level of accumulation. At some point, when they are over the limit, their performance drops quickly resulting in damage to, or disposal of the stored products inside. The Self-Cleaning Condenser device keeps the condenser clean and prevents system failure by automatically brushing daily.

■ **Digital temperature control & monitor system**

Keeps food products safe by maintaining constant temperatures. External digital display allows for easy monitoring.

■ **Hydrocarbon refrigerants (R-290)**

With innovative and eco-friendly technology, Turbo Air brings you hydrocarbon refrigerators designed to meet DOE's Energy Conservation Standards in 2017 and to use EPA's SNAP Program approved HC refrigerants. Hydrocarbon refrigerants do not deplete the ozone layer and have very low contribution to global warming (ODP-0, GWP-3).

■ **Stainless steel cabinet construction**

The PRO series model boasts a stainless steel interior and a 22 gauge stainless steel exterior (galvanized steel bottom). It guarantees the utmost in cleanliness and long product life. The PRO series adds a touch of style to the most refined setting.

■ **Sturdy, clean stainless steel shelving**

Shelves are the most important part of cleanliness as they come in direct contact with food. The PRO series uniquely provides stainless steel shelving (only PUF-48-D2R(L)-N, PUF-60-D2R(L)-N).

■ **Ergonomically designed doors**

Customers' fatigue fades away with easy grip handles and doors that open effortlessly. These features along with self-closing doors make this the ultimate choice in customer convenience (only PUF-48-D2R(L)-N, PUF-60-D2R(L)-N).

■ **High-density polyurethane insulation**

The entire cabinet structure and solid doors are foamed-in-place using high density, CFC free polyurethane insulation.

■ **Spring assisted heavy duty gravity hinge (only PUF-48-D2R(L)-N, PUF-60-D2R(L)-N)**

■ **Freezer holds -10°F ~ 0°F for the best in frozen food preservation**

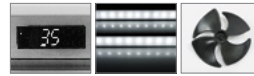

LED interior lighting & fan control

Energy efficient LED lighting lights every corner, making items easy to find. Fan control function automatically shuts off the fan when the door is open, which prevents hot air from being drawn in, thus maintaining the cool inner temperature (only PUF-48-D2R(L)-N, PUF-60-D2R(L)-N).

■ **Standard features**

- Anti-corrosion coated evaporator
- Self-contained system
- 4" dia. swivel casters with locks on the front set
- Door locks (only PUF-48-D2R(L)-N, PUF-60-D2R(L)-N)
- Lead time applies

■ **Optional features**

- Legs available for all models: 6"
- Stainless steel single/double overshef available (except PUF-28-D2-N)
- Casters available for all models: 1" (1.5" low profile caster kit for PUF-28-D2-N), 2.5" (except PUF-28-D2-N), 5"
- Stacking kit for PUF-28-D2-N available

PUF MODELS SPECIFICATIONS

ELECTRICAL DATA	PUF-28-D2-N	PUF-48-D2R(L)-N	PUF-48-D4-N	PUF-60-D2R(L)-N	PUF-60-D4-N
Voltage	115/60/1	115/60/1	115/60/1	115/60/1	115/60/1
Plug Type	Ⓢ NEMA 5-15P	Ⓢ NEMA 5-15P	Ⓢ NEMA 5-15P	Ⓢ NEMA 5-15P	Ⓢ NEMA 5-15P
Full Load Amp.	4.5	8	8	5.6	5.6
Compressor HP	1/4	1/3	1/3	1/2	1/2
Cord Length (ft.)	10	10	10	10	10
Refrigerant	R-290	R-290	R-290	R-290	R-290
DIMENSIONAL DATA					
Net Capacity (cu. ft.)	6.8	12.2	12.2	17.2	17.2
Ext. Dimension (L x D [†] x H [†]) (in.)	27 ^{1/2} x 30 x 30 ^{1/2}	48 ^{1/4} x 30 x 30 ^{1/2}	48 ^{1/4} x 30 x 30 ^{1/2}	60 ^{1/4} x 30 x 30 ^{1/2}	60 ^{1/4} x 30 x 30 ^{1/2}
# of Doors	-	1	-	1	-
# of Drawers	2	2	4	2	4
# of Shelves	-	1	-	1	-
Shelf Size (L x D) (in.)	-	21 x 17	-	27 x 17	-
Net Weight (lbs.)	160	240	242	265	267
Gross Weight (lbs.)	176	258	269	291	299

Design and specifications subject to change without notice. Most updated spec sheets are available at www.turboairinc.com.

Actual shipping weight may differ due to extra packing materials for product protection.

* Depth does not include 2" for door handles and rear spacers. † Height does not include 4-1/2" for caster height.

■ **WARRANTY: 5 Year Parts and Labor Warranty, 7 Year Compressor Warranty**

UNDERCOUNTER REF. - FRONT BREATHING AIRFLOW NATURAL Refrigerant

Self-Cleaning Condenser Equipped Units

■ **Self-Cleaning Condenser (Patented)**

The accumulation of dust in the condenser can cause the failure or breakdown of refrigerators. Refrigerators run normally until they reach a certain level of accumulation. At some point, when they are over the limit, their performance drops quickly resulting in damage to, or disposal of the stored products inside. The Self-Cleaning Condenser device keeps the condenser clean and prevents system failure by automatically brushing daily.

■ **Digital temperature control & monitor system**

Keeps food products safe by maintaining constant temperatures. External digital display allows for easy monitoring.

■ **Front Breathing airflow**

Front Breathing airflow is designed to draw in air and discharge from the front, allowing units to run at high efficiency in tight spaces and eliminates the need for surrounding clearances.

■ **Hydrocarbon refrigerants (R-290)**

With innovative and eco-friendly technology, Turbo Air brings you hydrocarbon refrigerators designed to meet DOE's Energy Conservation Standards in 2017 and to use EPA's SNAP Program approved HC refrigerants. Hydrocarbon refrigerants do not deplete the ozone layer and have very low contribution to global warming (ODP-0, GWP-3).

■ **Stainless steel cabinet construction**

The PRO series model boasts a stainless steel interior and a 22 gauge stainless steel exterior (galvanized steel bottom). It guarantees the utmost in cleanliness and long product life. The PRO series adds a touch of style to the most refined setting.

■ **Sturdy, clean stainless steel shelving**

Shelves are the most important part of cleanliness as they come in direct contact with food. The PRO series uniquely provides stainless steel shelving.

■ **Ergonomically designed doors**

Customers' fatigue fades away with easy grip handles and doors that open effortlessly. These features along with self-closing doors make this the ultimate choice in customer convenience.

■ **High-density polyurethane insulation**

The entire cabinet structure and solid doors are foamed-in-place using high density, CFC free polyurethane insulation.

■ **Spring assisted heavy duty gravity hinge**

■ **Refrigerator holds 33°F ~ 38°F for the best in food preservation**

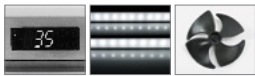

LED interior lighting & fan control

Energy efficient LED lighting lights every corner, making items easy to find. Fan control function automatically shuts off the fan when the door is open, which prevents hot air from being drawn in, thus maintaining the cool inner temperature.

■ **Standard features**

- Anti-corrosion coated evaporator
- Self-contained system
- 4" dia. swivel casters with locks on the front set
- Door locks
- Lead time applies

■ **Optional features**

- Legs available for all models: 6"
- Stainless steel single/double overshelf available (except PUR-28-FB-N)
- Casters available for all models: 1" (1.5" low profile caster kit for PUR-28-FB-N), 2.5" (except PUR-28-FB-N), 5"

PUR MODELS SPECIFICATIONS

ELECTRICAL DATA	PUR-28-FB-N	PUR-48-FB-N	PUR-60-FB-N	PUR-72-FB-N
Voltage	115/60/1	115/60/1	115/60/1	115/60/1
Plug Type	Ⓜ NEMA 5-15P	Ⓜ NEMA 5-15P	Ⓜ NEMA 5-15P	Ⓜ NEMA 5-15P
Full Load Amp.	3.8	8.9	8.9	5.7
Compressor HP	1/5	1/6	1/6	2/5
Cord Length (ft.)	10	10	10	10
Refrigerant	R-290	R-290	R-290	R-290
DIMENSIONAL DATA				
Net Capacity (cu. ft.)	6.5	11.1	14.8	17.6
Ext. Dimension (L x D x H†) (in.)	27 1/2 x 30 x 30 1/2	48 1/4 x 30 x 30 1/2	60 1/4 x 30 x 30 1/2	72 5/8 x 30 x 30 1/2
# of Doors	1	2	2	2
# of Shelves	1	2	2	2
Shelf Size (L x D) (in.)	22 1/2 x 17	21 x 17	27 x 17	33 1/8 x 17
Net Weight (lbs.)	153	235	255	318
Gross Weight (lbs.)	163	246	282	352

Design and specifications subject to change without notice. Most updated spec sheets are available at www.turboairinc.com.

Actual shipping weight may differ due to extra packing materials for product protection.

* Depth does not include 3/4" for door handles. † Height does not include 4-1/2" for caster height.

■ **WARRANTY: 5 Year Parts and Labor Warranty, 7 Year Compressor Warranty**

UNDERCOUNTER REF. - FRONT BREATHING AIRFLOW/DRAWERS

Self-Cleaning Condenser Equipped Units

■ **Self-Cleaning Condenser (Patented)**

The accumulation of dust in the condenser can cause the failure or breakdown of refrigerators. Refrigerators run normally until they reach a certain level of accumulation. At some point, when they are over the limit, their performance drops quickly resulting in damage to, or disposal of the stored products inside. The Self-Cleaning Condenser device keeps the condenser clean and prevents system failure by automatically brushing daily.

■ **Digital temperature control & monitor system**

Keeps food products safe by maintaining constant temperatures. External digital display allows for easy monitoring.

■ **Front Breathing airflow**

Front Breathing airflow is designed to draw in air and discharge from the front, allowing units to run at high efficiency in tight spaces and eliminates the need for surrounding clearances.

■ **Hydrocarbon refrigerants (R-290)**

With innovative and eco-friendly technology, Turbo Air brings you hydrocarbon refrigerators designed to meet DOE's Energy Conservation Standards in 2017 and to use EPA's SNAP Program approved HC refrigerants. Hydrocarbon refrigerants do not deplete the ozone layer and have very low contribution to global warming (ODP-0, GWP-3).

■ **Stainless steel cabinet construction**

The PRO series model boasts a stainless steel interior and a 22 gauge stainless steel exterior (galvanized steel bottom). It guarantees the utmost in cleanliness and long product life. The PRO series adds a touch of style to the most refined setting.

■ **Sturdy, clean stainless steel shelving**

Shelves are the most important part of cleanliness as they come in direct contact with food. The PRO series uniquely provides stainless steel shelving (only PUR-48-D2R(L)-FB-N).

■ **Ergonomically designed doors**

Customers' fatigue fades away with easy grip handles and doors that open effortlessly. These features along with self-closing doors make this the ultimate choice in customer convenience (only PUR-48-D2R(L)-FB-N).

■ **High-density polyurethane insulation**

The entire cabinet structure and solid doors are foamed-in-place using high density, CFC free polyurethane insulation.

■ **Spring assisted heavy duty gravity hinge (only PUR-48-D2R(L)-FB-N)**

■ **Refrigerator holds 33°F ~ 38°F for the best in food preservation**

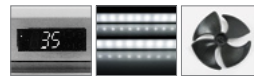
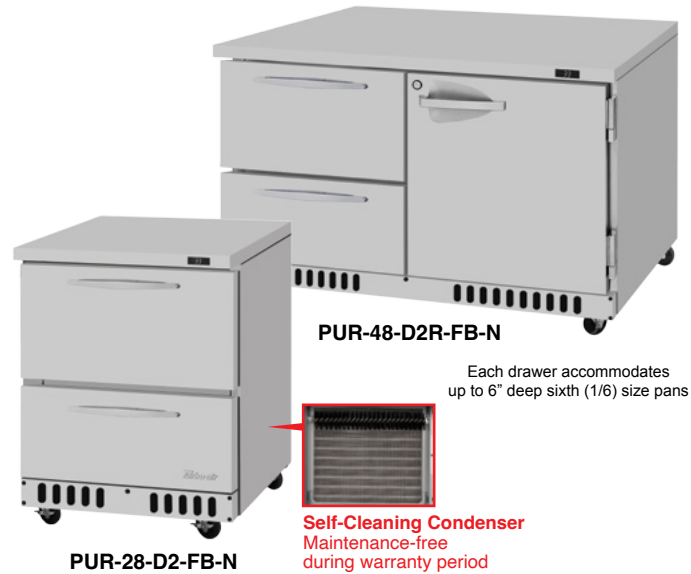

LED interior lighting & fan control

Energy efficient LED lighting lights every corner, making items easy to find. Fan control function automatically shuts off the fan when the door is open, which prevents hot air from being drawn in, thus maintaining the cool inner temperature (only PUR-48-D2R(L)-FB-N).

■ **Standard features**

- Anti-corrosion coated evaporator
- Self-contained system
- 4" dia. swivel casters with locks on the front set
- Door locks
- Lead time applies

■ **Optional features**

- Legs available for all models: 6"
- Stainless steel single/double overshef available (except PUR-28-D2-FB-N)
- Casters available for all models: 1" (1.5" low profile caster kit for PUR-28-D2-FB-N), 2.5" (except PUR-28-D2-FB-N), 5"

PUR MODELS SPECIFICATIONS

ELECTRICAL DATA	PUR-28-D2-FB-N	PUR-48-D2R(L)-FB-N	PUR-48-D4-FB-N
Voltage	115/60/1	115/60/1	115/60/1
Plug Type	Ⓜ NEMA 5-15P	Ⓜ NEMA 5-15P	Ⓜ NEMA 5-15P
Full Load Amp.	6.6	6.5	6.5
Compressor HP	1/6	1/6	1/6
Cord Length (ft.)	10	10	10
Refrigerant	R-290	R-290	R-290
DIMENSIONAL DATA			
Net Capacity (cu. ft.)	6.5	11.1	11.1
Ext. Dimension (L x D* x H†) (in.)	27 1/2 x 30 x 30 1/2	48 1/4 x 30 x 30 1/2	48 1/4 x 30 x 30 1/2
# of Doors	-	1	-
# of Drawers	2	2	4
# of Shelves	-	1	-
Shelf Size (L x D) (in.)	-	21 x 17	-
Net Weight (lbs.)	159	240	245
Gross Weight (lbs.)	175	259	267

Design and specifications subject to change without notice. Most updated spec sheets are available at www.turboairinc.com.

Actual shipping weight may differ due to extra packing materials for product protection.

* Depth does not include 7/8" for drawer handles. † Height does not include 4-1/2" for caster height.

■ **WARRANTY: 5 Year Parts and Labor Warranty, 7 Year Compressor Warranty**

UNDERCOUNTER REF. - FRONT BREATHING AIRFLOW/DRAWERS

Self-Cleaning Condenser Equipped Units

Self-Cleaning Condenser (Patented)

The accumulation of dust in the condenser can cause the failure or breakdown of refrigerators. Refrigerators run normally until they reach a certain level of accumulation. At some point, when they are over the limit, their performance drops quickly resulting in damage to, or disposal of the stored products inside. The Self-Cleaning Condenser device keeps the condenser clean and prevents system failure by automatically brushing daily.

Digital temperature control & monitor system

Keeps food products safe by maintaining constant temperatures. External digital display allows for easy monitoring.

Front Breathing airflow

Front Breathing airflow is designed to draw in air and discharge from the front, allowing units to run at high efficiency in tight spaces and eliminates the need for surrounding clearances.

Hydrocarbon refrigerants (R-290)

With innovative and eco-friendly technology, Turbo Air brings you hydrocarbon refrigerators designed to meet DOE's Energy Conservation Standards in 2017 and to use EPA's SNAP Program approved HC refrigerants. Hydrocarbon refrigerants do not deplete the ozone layer and have very low contribution to global warming (ODP-0, GWP-3).

Stainless steel cabinet construction

The PRO series model boasts a stainless steel interior and a 22 gauge stainless steel exterior (galvanized steel bottom). It guarantees the utmost in cleanliness and long product life. The PRO series adds a touch of style to the most refined setting.

Sturdy, clean stainless steel shelving

Shelves are the most important part of cleanliness as they come in direct contact with food. The PRO series uniquely provides stainless steel shelving (only PUR-60-D2R(L)-FB-N, PUR-72-D2R(L)-FB-N).

Ergonomically designed doors

Customers' fatigue fades away with easy grip handles and doors that open effortlessly. These features along with self-closing doors make this the ultimate choice in customer convenience (only PUR-60-D2R(L)-FB-N, PUR-72-D2R(L)-FB-N).

High-density polyurethane insulation

The entire cabinet structure and solid doors are foamed-in-place using high density, CFC free polyurethane insulation.

Spring assisted heavy duty gravity hinge

(only PUR-60-D2R(L)-FB-N, PUR-72-D2R(L)-FB-N)

Refrigerator holds 33°F ~ 38°F for the best in food preservation



PUR-60-D2R-FB-N

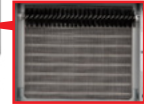

Self-Cleaning Condenser Maintenance-free during warranty period



PUR-60-D4-FB-N

Each drawer accommodates up to 6" deep sixth (1/6) size pans



LED interior lighting & fan control

Energy efficient LED lighting lights every corner, making items easy to find. Fan control function automatically shuts off the fan when the door is open, which prevents hot air from being drawn in, thus maintaining the cool inner temperature (only PUR-60-D2R(L)-FB-N, PUR-72-D2R(L)-FB-N).

Standard features

- Anti-corrosion coated evaporator
- Self-contained system
- 4" dia. swivel casters with locks on the front set
- Door locks
- Lead time applies

Optional features

- Legs available for all models: 6"
- Stainless steel single/double overshef available
- Casters available for all models: 1", 2.5", 5"

PUR MODELS SPECIFICATIONS

ELECTRICAL DATA	PUR-60-D2R(L)-FB-N	PUR-60-D4-FB-N	PUR-72-D2R(L)-FB-N	PUR-72-D4-FB-N
Voltage	115/60/1	115/60/1	115/60/1	115/60/1
Plug Type	Ⓢ NEMA 5-15P	Ⓢ NEMA 5-15P	Ⓢ NEMA 5-15P	Ⓢ NEMA 5-15P
Full Load Amp.	8.9	8.9	9.9	9.9
Compressor HP	1/6	1/6	1/6	1/6
Cord Length (ft.)	10	10	10	10
Refrigerant	R-290	R-290	R-290	R-290
DIMENSIONAL DATA				
Net Capacity (cu. ft.)	14.8	14.8	17.6	17.6
Ext. Dimension (L x D* x H†) (in.)	60 1/4 x 30 x 30 1/2	60 1/4 x 30 x 30 1/2	72 5/8 x 30 x 30 1/2	72 5/8 x 30 x 30 1/2
# of Doors	1	-	1	-
# of Drawers	2	4	2	4
# of Shelves	1	-	1	-
Shelf Size (L x D) (in.)	27 x 17	-	33 1/8 x 17	-
Net Weight (lbs.)	265	268	324	327
Gross Weight (lbs.)	293	298	359	362

Design and specifications subject to change without notice. Most updated spec sheets are available at www.turboairinc.com.

Actual shipping weight may differ due to extra packing materials for product protection.

* Depth does not include 7/8" for drawer handles. † Height does not include 4-1/2" for caster height.

WARRANTY: 5 Year Parts and Labor Warranty, 7 Year Compressor Warranty

UNDERCOUNTER FREEZER - FRONT BREATHING AIRFLOW

Self-Cleaning Condenser Equipped Units

■ **Self-Cleaning Condenser (Patented)**

The accumulation of dust in the condenser can cause the failure or breakdown of refrigerators. Refrigerators run normally until they reach a certain level of accumulation. At some point, when they are over the limit, their performance drops quickly resulting in damage to, or disposal of the stored products inside. The Self-Cleaning Condenser device keeps the condenser clean and prevents system failure by automatically brushing daily.

■ **Digital temperature control & monitor system**

Keeps food products safe by maintaining constant temperatures. External digital display allows for easy monitoring.

■ **Front Breathing airflow**

Front Breathing airflow is designed to draw in air and discharge from the front, allowing units to run at high efficiency in tight spaces and eliminates the need for surrounding clearances.

■ **Hydrocarbon refrigerants (R-290)**

With innovative and eco-friendly technology, Turbo Air brings you hydrocarbon refrigerators designed to meet DOE's Energy Conservation Standards in 2017 and to use EPA's SNAP Program approved HC refrigerants. Hydrocarbon refrigerants do not deplete the ozone layer and have very low contribution to global warming (ODP-0, GWP-3).

■ **Stainless steel cabinet construction**

The PRO series model boasts a stainless steel interior and a 22 gauge stainless steel exterior (galvanized steel bottom). It guarantees the utmost in cleanliness and long product life. The PRO series adds a touch of style to the most refined setting.

■ **Sturdy, clean stainless steel shelving**

Shelves are the most important part of cleanliness as they come in direct contact with food. The PRO series uniquely provides stainless steel shelving.

■ **Ergonomically designed doors**

Customers' fatigue fades away with easy grip handles and doors that open effortlessly. These features along with self-closing doors make this the ultimate choice in customer convenience.

■ **High-density polyurethane insulation**

The entire cabinet structure and solid doors are foamed-in-place using high density, CFC free polyurethane insulation.

■ **Spring assisted heavy duty gravity hinge**

■ **Freezer holds -10°F ~ 0°F for the best in food preservation**

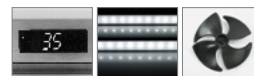
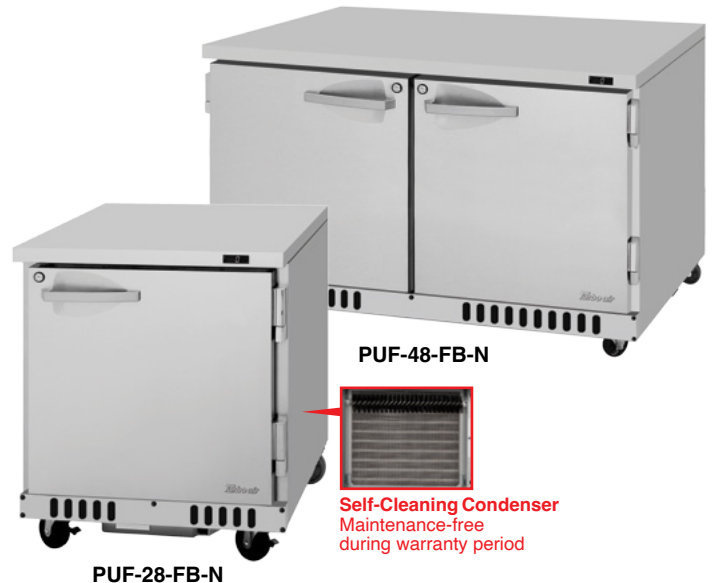

LED interior lighting & fan control

Energy efficient LED lighting lights every corner, making items easy to find. Fan control function automatically shuts off the fan when the door is open, which prevents hot air from being drawn in, thus maintaining the cool inner temperature.

■ **Standard features**

- Anti-corrosion coated evaporator
- Self-contained system
- 4" dia. swivel casters with locks on the front set
- Door locks
- Lead time applies

■ **Optional features**

- Legs available for all models: 6"
- Stainless steel single/double overshelf available (except PUF-28-FB-N)
- Casters available for all models: 1" (1.5" low profile caster kit for PUF-28-FB-N), 2.5" (except PUF-28-FB-N), 5"

PUF MODELS SPECIFICATIONS

ELECTRICAL DATA	PUF-28-FB-N	PUF-48-FB-N	PUF-60-FB-N
Voltage	115/60/1	115/60/1	115/60/1
Plug Type	Ⓜ NEMA 5-15P	Ⓜ NEMA 5-15P	Ⓜ NEMA 5-15P
Full Load Amp.	4.5	8	5.6
Compressor HP	1/4	1/3	1/2
Cord Length (ft.)	10	10	10
Refrigerant	R-290	R-290	R-290
DIMENSIONAL DATA			
Net Capacity (cu. ft.)	6.5	11.1	14.8
Ext. Dimension (L x D* x H†) (in.)	27 1/2 x 30 x 30 1/2	48 1/4 x 30 x 30 1/2	60 1/4 x 30 x 30 1/2
# of Doors	1	2	2
# of Shelves	1	2	2
Shelf Size (L x D) (in.)	22 1/2 x 17	21 x 17	27 x 17
Net Weight (lbs.)	154	235	254
Gross Weight (lbs.)	163	246	282

Design and specifications subject to change without notice. Most updated spec sheets are available at www.turboairinc.com.

Actual shipping weight may differ due to extra packing materials for product protection.

* Depth does not include 3/4" for door handles. † Height does not include 4-1/2" for caster height.

■ **WARRANTY: 5 Year Parts and Labor Warranty, 7 Year Compressor Warranty**

UNDERCOUNTER FREEZER - FRONT BREATHING AIRFLOW/DRAWERS

Self-Cleaning Condenser Equipped Units

■ **Self-Cleaning Condenser (Patented)**

The accumulation of dust in the condenser can cause the failure or breakdown of refrigerators. Refrigerators run normally until they reach a certain level of accumulation. At some point, when they are over the limit, their performance drops quickly resulting in damage to, or disposal of the stored products inside. The Self-Cleaning Condenser device keeps the condenser clean and prevents system failure by automatically brushing daily.

■ **Digital temperature control & monitor system**

Keeps food products safe by maintaining constant temperatures. External digital display allows for easy monitoring.

■ **Front Breathing airflow**

Front Breathing airflow is designed to draw in air and discharge from the front, allowing units to run at high efficiency in tight spaces and eliminates the need for surrounding clearances.

■ **Hydrocarbon refrigerants (R-290)**

With innovative and eco-friendly technology, Turbo Air brings you hydrocarbon refrigerators designed to meet DOE's Energy Conservation Standards in 2017 and to use EPA's SNAP Program approved HC refrigerants. Hydrocarbon refrigerants do not deplete the ozone layer and have very low contribution to global warming (ODP-0, GWP-3).

■ **Stainless steel cabinet construction**

The PRO series model boasts a stainless steel interior and a 22 gauge stainless steel exterior (galvanized steel bottom). It guarantees the utmost in cleanliness and long product life. The PRO series adds a touch of style to the most refined setting.

■ **Sturdy, clean stainless steel shelving**

Shelves are the most important part of cleanliness as they come in direct contact with food. The PRO series uniquely provides stainless steel shelving (only PUF-48-D2R(L)-FB-N, PUF-60-D2R(L)-FB-N).

■ **Ergonomically designed doors**

Customers' fatigue fades away with easy grip handles and doors that open effortlessly. These features along with self-closing doors make this the ultimate choice in customer convenience (only PUF-48-D2R(L)-FB-N, PUF-60-D2R(L)-FB-N).

■ **High-density polyurethane insulation**

The entire cabinet structure and solid doors are foamed-in-place using high density, CFC free polyurethane insulation.

■ **Spring assisted heavy duty gravity hinge (only PUF-48-D2R(L)-FB-N, PUF-60-D2R(L)-FB-N)**

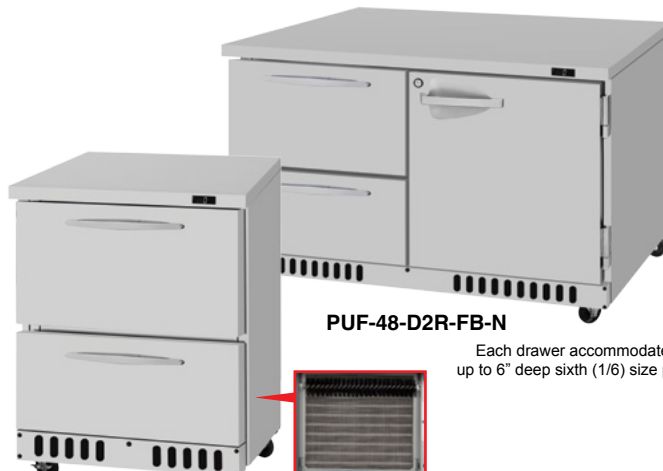

PUF-48-D2R-FB-N

Each drawer accommodates up to 6" deep sixth (1/6) size pans

PUF-28-D2-FB-N

Self-Cleaning Condenser Maintenance-free during warranty period



LED interior lighting & fan control

Energy efficient LED lighting lights every corner, making items easy to find. Fan control function automatically shuts off the fan when the door is open, which prevents hot air from being drawn in, thus maintaining the cool inner temperature (only PUF-48-D2R(L)-FB-N, PUF-60-D2R(L)-FB-N).

■ **Freezer holds -10°F ~ 0°F for the best in food preservation**

■ **Standard features**

- Anti-corrosion coated evaporator
- Self-contained system
- 4" dia. swivel casters with locks on the front set
- Door locks
- Lead time applies

■ **Optional features**

- Legs available for all models: 6"
- Stainless steel single/double overshef available (except PUF-28-D2-FB-N)
- Casters available for all models: 1" (1.5" low profile caster kit for PUF-28-D2-FB-N), 2.5" (except PUF-28-D2-FB-N), 5"

PUF MODELS SPECIFICATIONS

ELECTRICAL DATA	PUF-28-D2-FB-N	PUF-48-D2R(L)-FB-N	PUF-48-D4-FB-N	PUF-60-D2R(L)-FB-N	PUF-60-D4-FB-N
Voltage	115/60/1	115/60/1	115/60/1	115/60/1	115/60/1
Plug Type	Ⓜ NEMA 5-15P	Ⓜ NEMA 5-15P	Ⓜ NEMA 5-15P	Ⓜ NEMA 5-15P	Ⓜ NEMA 5-15P
Full Load Amp.	4.5	8	8	5.6	5.6
Compressor HP	1/4	1/3	1/3	1/2	1/2
Cord Length (ft.)	10	10	10	10	10
Refrigerant	R-290	R-290	R-290	R-290	R-290
DIMENSIONAL DATA					
Net Capacity (cu. ft.)	6.5	11.1	11.1	14.8	14.8
Ext. Dimension (L x D* x H†) (in.)	27 1/2 x 30 x 30 1/2	48 1/4 x 30 x 30 1/2	48 1/4 x 30 x 30 1/2	60 1/4 x 30 x 30 1/2	60 1/4 x 30 x 30 1/2
# of Doors	-	1	-	1	-
# of Drawers	2	2	4	2	4
# of Shelves	-	1	-	1	-
Shelf Size (L x D) (in.)	-	21 x 17	-	27 x 17	-
Net Weight (lbs.)	160	240	242	265	267
Gross Weight (lbs.)	176	258	269	291	299

Design and specifications subject to change without notice. Most updated spec sheets are available at www.turboairinc.com.

Actual shipping weight may differ due to extra packing materials for product protection.

* Depth does not include 7/8" for drawer handles. † Height does not include 4-1/2" for caster height.

■ **WARRANTY: 5 Year Parts and Labor Warranty, 7 Year Compressor Warranty**

UNDERCOUNTER REFRIGERATORS NATURAL Refrigerant

Self-Cleaning Condenser Equipped Units

■ **Self-Cleaning Condenser (Patented)**

The accumulation of dust in the condenser can cause the failure or breakdown of refrigerators. Refrigerators run normally until they reach a certain level of accumulation. At some point, when they are over the limit, their performance drops quickly resulting in damage to, or disposal of the stored products inside. The Self-Cleaning Condenser device keeps the condenser clean and prevents system failure by automatically brushing daily.

■ **Digital temperature control & monitor system**

Keeps food products safe by maintaining constant temperatures. External digital display allows for easy monitoring.

■ **Hydrocarbon refrigerants (R-290 / R-600a)**

With innovative and eco-friendly technology, Turbo Air brings you hydrocarbon refrigerators designed to meet DOE's Energy Conservation Standards in 2017 and to use EPA's SNAP Program approved HC refrigerants. Hydrocarbon refrigerants do not deplete the ozone layer and have very low contribution to global warming (ODP-0, GWP-3).

■ **Stainless steel cabinet construction**

The Turbo Air Super Deluxe model boasts a stainless steel interior and exterior (galvanized steel back & bottom). It guarantees the utmost in cleanliness and long product life. The Super Deluxe adds a touch of style to the most refined setting.

■ **Sturdy, clean stainless steel shelving**

Shelves are the most important part of cleanliness as they come in direct contact with food. After a while, PVC coated wire shelves may peel, rust and lead to unsanitary conditions. The Turbo Air Super Deluxe series uniquely provides stainless steel shelving.

■ **Ergonomically designed doors**

Customers' fatigue fades away with easy grip handles and doors that open effortlessly. These features along with self-closing doors make this the ultimate choice in customer convenience. ABS sheet door liners resist water condensation with thermal efficiency.

■ **Left hinged (TUR-28SD-N-L), all left hinged (TUR-48SD-N-AL), all right hinged (TUR-48SD-N-AR) models available**

■ **Extended countertop model available (TUR-48SD-E-N)**

■ **Refrigerator holds 33°F ~ 38°F for the best in food preservation**

■ **Standard features**

- Anti-corrosion coated evaporator
- Self-contained system
- 4" dia. swivel casters with locks on the front set
- High-density polyurethane insulation
- Door locks



TUR-72SD-N



TUR-48SD-N

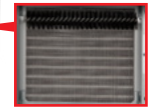

Self-Cleaning Condenser
Maintenance-free during warranty period

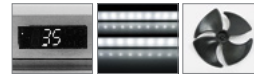

LED interior lighting & fan control

Energy efficient LED lighting lights every corner, making items easy to find. Fan control function automatically shuts off the fan when the door is open, which prevents hot air from being drawn in, thus maintaining the cool inner temperature.

■ **Optional features**

- Legs available for all models: 6"
- Stainless steel single/double overshelf available (except TUR-28SD-N, single not applicable to TUR-36SD-N6)
- Casters available for all models: 1", 2.5", 5"
- Back splash guard available

TUR MODELS SPECIFICATIONS

ELECTRICAL DATA	TUR-28SD-N	TUR-36SD-N6	TUR-48SD-N	TUR-60SD-N	TUR-72SD-N
Voltage	115/60/1	115/60/1	115/60/1	115/60/1	115/60/1
Plug Type	Ⓜ NEMA 5-15P	Ⓜ NEMA 5-15P	Ⓜ NEMA 5-15P	Ⓜ NEMA 5-15P	Ⓜ NEMA 5-15P
Full Load Amp.	2.2	2.3	2.5	2.4	2.5
Compressor HP	1/6	1/5	1/6	1/6	1/6
Cord Length (ft.)	9	9	9	9	9
Refrigerant	R-290	R-600a	R-290	R-290	R-290
DIMENSIONAL DATA					
Net Capacity (cu. ft.)	6.8	9	12.2	17	18.8
Ext. Dimension (L x D* x H†) (in.)	27 1/2 x 30 x 30 1/2	36 3/8 x 30 x 30 1/2	48 1/4 x 30 x 30 1/2	60 1/4 x 30 x 30 1/2	72 5/8 x 30 x 30 1/2
# of Doors	1	2	2	2	3
# of Shelves	1	2	2	2	3
Shelf Size (L x D) (in.)	22 1/2 x 17	15 x 17	21 x 17	27 x 17	21 x 17 (L/R), 23 x 17 (M)
Net Weight (lbs.)	146	167	224	243	303
Gross Weight (lbs.)	163	187	246	282	352

Design and specifications subject to change without notice. Most updated spec sheets are available at www.turboairinc.com.

Actual shipping weight may differ due to extra packing materials for product protection.

* Depth does not include 1" for rear spacers. † Height does not include 4-3/4" for caster height.

■ **WARRANTY: 5 Year Parts and Labor Warranty, 7 Year Compressor Warranty**

UNDERCOUNTER REFRIGERATORS - DRAWERS NATURAL Refrigerant

Self-Cleaning Condenser Equipped Units

■ **Self-Cleaning Condenser (Patented)**

The accumulation of dust in the condenser can cause the failure or breakdown of refrigerators. Refrigerators run normally until they reach a certain level of accumulation. At some point, when they are over the limit, their performance drops quickly resulting in damage to, or disposal of the stored products inside. The Self-Cleaning Condenser device keeps the condenser clean and prevents system failure by automatically brushing daily.

■ **Digital temperature control & monitor system**

Keeps food products safe by maintaining constant temperatures. External digital display allows for easy monitoring.

■ **Hydrocarbon refrigerants (R-290)**

With innovative and eco-friendly technology, Turbo Air brings you hydrocarbon refrigerators designed to meet DOE's Energy Conservation Standards in 2017 and to use EPA's SNAP Program approved HC refrigerants. Hydrocarbon refrigerants do not deplete the ozone layer and have very low contribution to global warming (ODP-0, GWP-3).

■ **Stainless steel cabinet construction**

The Turbo Air Super Deluxe model boasts a stainless steel interior and exterior (galvanized steel back & bottom). It guarantees the utmost in cleanliness and long product life. The Super Deluxe adds a touch of style to the most refined setting.

■ **Sturdy, clean stainless steel shelving**

Shelves are the most important part of cleanliness as they come in direct contact with food. After a while, PVC coated wire shelves may peel, rust and lead to unsanitary conditions. The Super Deluxe series uniquely provides stainless steel shelving (only TUR-48SD-D2-N, TUR-60SD-D2-N).

■ **Ergonomically designed doors**

Customers' fatigue fades away with easy grip handles and doors that open effortlessly. These features along with self-closing doors make this the ultimate choice in customer convenience. ABS sheet door liners resist water condensation with thermal efficiency (only TUR-48SD-D2-N, TUR-60SD-D2-N).

■ **High-density polyurethane insulation**

The entire cabinet structure and solid doors are foamed-in-place using high density, CFC free polyurethane insulation.

■ **Refrigerator holds 33°F ~ 38°F for the best in food preservation**



TUR-60SD-D2-N

Each drawer accommodates up to 6" deep sixth (1/6) size pans (drawer pans not included)



TUR-48SD-D4-N



TUR-28SD-D2-N

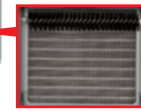

Self-Cleaning Condenser
Maintenance-free during warranty period

■ **Standard features**

- Anti-corrosion coated evaporator
- Self-contained system
- 4" dia. swivel casters with locks on the front set

■ **Optional features**

- Legs available for all models: 6"
- Stainless steel single/double overshelf available (except TUR-28SD-D2-N)
- Casters available for all models: 1", 2.5", 5"
- Back splash guard available

TUR MODELS SPECIFICATIONS

ELECTRICAL DATA	TUR-28SD-D2-N	TUR-48SD-D2-N	TUR-48SD-D4-N	TUR-60SD-D2-N	TUR-60SD-D4-N
Voltage	115/60/1	115/60/1	115/60/1	115/60/1	115/60/1
Plug Type	Ⓜ NEMA 5-15P	Ⓜ NEMA 5-15P	Ⓜ NEMA 5-15P	Ⓜ NEMA 5-15P	Ⓜ NEMA 5-15P
Full Load Amp.	2.2	2.4	2.5	2.4	2.4
Compressor HP	1/6	1/6	1/6	1/6	1/6
Cord Length (ft.)	9	9	9	9	9
Refrigerant	R-290	R-290	R-290	R-290	R-290
DIMENSIONAL DATA					
Net Capacity (cu. ft.)	6.8	12.2	12.2	17	17
Ext. Dimension (L x D* x H†) (in.)	27 1/2 x 30 x 30 1/2	48 1/4 x 30 x 30 1/2	48 1/4 x 30 x 30 1/2	60 1/4 x 30 x 30 1/2	60 1/4 x 30 x 30 1/2
# of Doors	-	1	-	1	-
# of Drawers	2	2	4	2	4
# of Shelves	-	1	-	1	-
Shelf Size (L x D) (in.)	-	21 x 17	-	27 x 17	-
Net Weight (lbs.)	152	231	238	250	263
Gross Weight (lbs.)	169	253	260	288	301

Design and specifications subject to change without notice. Most updated spec sheets are available at www.turboairinc.com.

Actual shipping weight may differ due to extra packing materials for product protection.

* Depth does not include 1" for rear spacers. † Height does not include 4-3/4" for caster height.

■ **WARRANTY: 5 Year Parts and Labor Warranty, 7 Year Compressor Warranty**

UNDERCOUNTER FREEZERS NATURAL Refrigerant

Self-Cleaning Condenser Equipped Units

■ **Self-Cleaning Condenser (Patented)**

The accumulation of dust in the condenser can cause the failure or breakdown of refrigerators. Refrigerators run normally until they reach a certain level of accumulation. At some point, when they are over the limit, their performance drops quickly resulting in damage to, or disposal of the stored products inside. The Self-Cleaning Condenser device keeps the condenser clean and prevents system failure by automatically brushing daily.

■ **Digital temperature control & monitor system**

Keeps food products safe by maintaining constant temperatures. External digital display allows for easy monitoring.

■ **Hydrocarbon refrigerants (R-290)**

With innovative and eco-friendly technology, Turbo Air brings you hydrocarbon refrigerators designed to meet DOE's Energy Conservation Standards in 2017 and to use EPA's SNAP Program approved HC refrigerants. Hydrocarbon refrigerants do not deplete the ozone layer and have very low contribution to global warming (ODP-0, GWP-3).

■ **Stainless steel cabinet construction**

The Turbo Air Super Deluxe model boasts a stainless steel interior and exterior (galvanized steel back & bottom). It guarantees the utmost in cleanliness and long product life. The Super Deluxe adds a touch of style to the most refined setting.

■ **Sturdy, clean stainless steel shelving**

Shelves are the most important part of cleanliness as they come in direct contact with food. After a while, PVC coated wire shelves may peel, rust and lead to unsanitary conditions. The Super Deluxe series uniquely provides stainless steel shelving.

■ **Ergonomically designed doors**

Customers' fatigue fades away with easy grip handles and doors that open effortlessly. These features along with self-closing doors make this the ultimate choice in customer convenience. ABS sheet door liners resist water condensation with thermal efficiency.

■ **High-density polyurethane insulation**

The entire cabinet structure and solid doors are foamed-in-place using high density, CFC free polyurethane insulation.

■ **Left hinged model available (TUF-28SD-N-L)**

■ **Freezer holds -10°F ~ 0°F for the best in frozen food preservation**

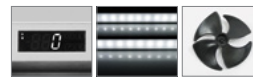
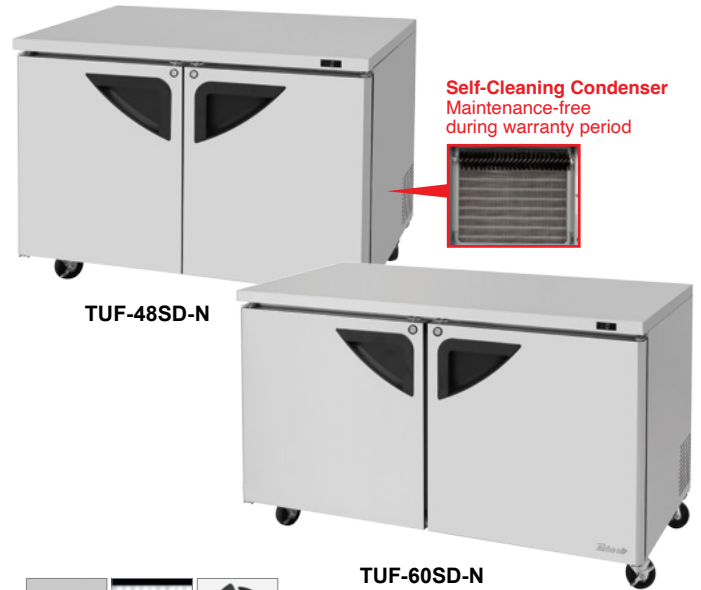

LED interior lighting & fan control

Energy efficient LED lighting lights every corner, making items easy to find. Fan control function automatically shuts off the fan when the door is open, which prevents hot air from being drawn in, thus maintaining the cool inner temperature.

■ **Standard features**

- Anti-corrosion coated evaporator
- Self-contained system
- 4" dia. swivel casters with locks on the front set
- Door locks

■ **Optional features**

- Legs available for all models: 6"
- Stainless steel single/double overshef available (except TUF-28SD-N, single not applicable to TUF-36SD-N)
- Casters available for all models: 1", 2.5", 5"
- Back splash guard available

TUF MODELS SPECIFICATIONS

ELECTRICAL DATA	TUF-28SD-N	TUF-36SD-N	TUF-48SD-N	TUF-60SD-N
Voltage	115/60/1	115/60/1	115/60/1	115/60/1
Plug Type	Ⓜ NEMA 5-15P	Ⓜ NEMA 5-15P	Ⓜ NEMA 5-15P	Ⓜ NEMA 5-15P
Full Load Amp.	1.9	3.0	2.8	4.8
Compressor HP	1/4+	1/3+	1/3	2/3
Cord Length (ft.)	9	9	9	9
Refrigerant	R-290	R-290	R-290	R-290
DIMENSIONAL DATA				
Net Capacity (cu. ft.)	6.8	9	12.2	17
Ext. Dimension (L x D x H†) (in.)	27 1/2 x 30 x 30 1/2	36 3/8 x 30 x 30 1/2	48 1/4 x 30 x 30 1/2	60 1/4 x 30 x 30 1/2
# of Doors	1	2	2	2
# of Shelves	1	2	2	2
Shelf Size (L x D) (in.)	22 1/2 x 17	15 x 17	21 x 17	27 x 17
Net Weight (lbs.)	146	160	224	243
Gross Weight (lbs.)	163	187	246	282

Design and specifications subject to change without notice. Most updated spec sheets are available at www.turboairinc.com.

Actual shipping weight may differ due to extra packing materials for product protection.

* Depth does not include 1" for rear spacers. † Height does not include 4-3/4" for caster height.

■ **WARRANTY: 5 Year Parts and Labor Warranty, 7 Year Compressor Warranty**

UNDERCOUNTER FREEZERS - DRAWERS NATURAL Refrigerant

Self-Cleaning Condenser Equipped Units

■ **Self-Cleaning Condenser (Patented)**

The accumulation of dust in the condenser can cause the failure or breakdown of refrigerators. Refrigerators run normally until they reach a certain level of accumulation. At some point, when they are over the limit, their performance drops quickly resulting in damage to, or disposal of the stored products inside. The Self-Cleaning Condenser device keeps the condenser clean and prevents system failure by automatically brushing daily.

■ **Digital temperature control & monitor system**

Keeps food products safe by maintaining constant temperatures. External digital display allows for easy monitoring.

■ **Hydrocarbon refrigerants (R-290)**

With innovative and eco-friendly technology, Turbo Air brings you hydrocarbon refrigerators designed to meet DOE's Energy Conservation Standards in 2017 and to use EPA's SNAP Program approved HC refrigerants. Hydrocarbon refrigerants do not deplete the ozone layer and have very low contribution to global warming (ODP-0, GWP-3).

■ **Stainless steel cabinet construction**

The Turbo Air Super Deluxe model boasts a stainless steel interior, exterior (galvanized steel back & bottom) and durable stainless steel drawers. It guarantees the utmost in cleanliness and long product life. The Super Deluxe adds a touch of style to the most refined setting.

■ **Sturdy, clean stainless steel shelving**

Shelves are the most important part of cleanliness as they come in direct contact with food. After a while, PVC coated wire shelves may peel, rust and lead to unsanitary conditions. The Super Deluxe series uniquely provides stainless steel shelving (only TUF-48SD-D2-N).

■ **High-density polyurethane insulation**

The entire cabinet structure and solid doors are foamed-in-place using high density, CFC free polyurethane insulation.

■ **Ergonomically designed doors**

Customers' fatigue fades away with easy grip handles and doors that open effortlessly. These features along with self-closing doors make this the ultimate choice in customer convenience. ABS sheet door liners resist water condensation with thermal efficiency (only TUF-48SD-D2-N).

■ **Freezer holds -10°F ~ 0°F for the best in frozen food preservation**

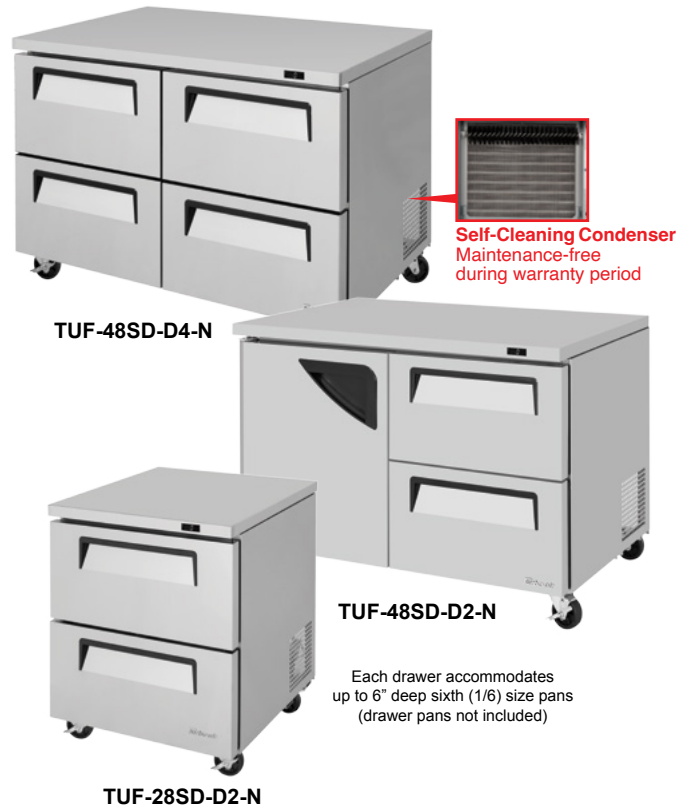

■ **Standard features**

- Anti-corrosion coated evaporator
- Self-contained system
- 4" dia. swivel casters with locks on the front set

■ **Optional features**

- Legs available for all models: 6"
- Stainless steel single/double overshef available (except TUF-28SD-D2-N)
- Casters available for all models: 1", 2.5", 5"
- Back splash guard available

TUF MODELS SPECIFICATIONS

ELECTRICAL DATA	TUF-28SD-D2-N	TUF-48SD-D2-N	TUF-60SD-D2-N	TUF-48SD-D4-N
Voltage	115/60/1	115/60/1	115/60/1	115/60/1
Plug Type	Ⓜ NEMA 5-15P	Ⓜ NEMA 5-15P	Ⓜ NEMA 5-15P	Ⓜ NEMA 5-15P
Full Load Amp.	1.9	2.8	4.8	2.8
Compressor HP	1/4+	1/3	1/2	1/3
Cord Length (ft.)	9	9	10	9
Refrigerant	R-290	R-290	R-290	R-290
DIMENSIONAL DATA				
Net Capacity (cu. ft.)	6.8	12.2	17	12.2
Ext. Dimension (L x D* x H†) (in.)	27 1/2 x 30 x 30 1/2	48 1/4 x 30 x 30 1/2	60 1/4 x 30 x 30 1/2	48 1/4 x 30 x 30 1/2
# of Doors	-	1	1	-
# of Drawers	2	2	2	4
# of Shelves	-	1	1	-
Shelf Size (L x D) (in.)	-	21 x 17	27 x 17	-
Net Weight (lbs.)	152	231	250	238
Gross Weight (lbs.)	169	253	288	260

Design and specifications subject to change without notice. Most updated spec sheets are available at www.turboairinc.com.

Actual shipping weight may differ due to extra packing materials for product protection.

* Depth does not include 1" for rear spacers. † Height does not include 4-3/4" for caster height.

■ **WARRANTY: 5 Year Parts and Labor Warranty, 7 Year Compressor Warranty**

UNDERCOUNTER FREEZERS - DRAWERS NATURAL Refrigerant

Self-Cleaning Condenser Equipped Units

■ **Self-Cleaning Condenser (Patented)**

The accumulation of dust in the condenser can cause the failure or breakdown of refrigerators. Refrigerators run normally until they reach a certain level of accumulation. At some point, when they are over the limit, their performance drops quickly resulting in damage to, or disposal of the stored products inside. The Self-Cleaning Condenser device keeps the condenser clean and prevents system failure by automatically brushing daily.

■ **Digital temperature control & monitor system**

Keeps food products safe by maintaining constant temperatures. External digital display allows for easy monitoring.

■ **Hydrocarbon refrigerants (R-290)**

With innovative and eco-friendly technology, Turbo Air brings you hydrocarbon refrigerators designed to meet DOE's Energy Conservation Standards in 2017 and to use EPA's SNAP Program approved HC refrigerants. Hydrocarbon refrigerants do not deplete the ozone layer and have very low contribution to global warming (ODP-0, GWP-3).

■ **Stainless steel cabinet construction**

The Turbo Air Super Deluxe model boasts a stainless steel interior, exterior (galvanized steel back & bottom) and durable stainless steel drawers. It guarantees the utmost in cleanliness and long product life. The Super Deluxe adds a touch of style to the most refined setting.

■ **Sturdy, clean stainless steel shelving**

Shelves are the most important part of cleanliness as they come in direct contact with food. After a while, PVC coated wire shelves may peel, rust and lead to unsanitary conditions. The Super Deluxe series uniquely provides stainless steel shelving (only TUF-48SD-D2R-N).

■ **Magnetic door gaskets**

Magnetic door gaskets are of one-piece construction, removable without tools for ease of cleaning and replacement.

■ **High-density polyurethane insulation**

The entire cabinet structure and solid doors are foamed-in-place using high density, CFC free polyurethane insulation.

■ **Ergonomically designed doors**

Customers' fatigue fades away with easy grip handles and doors that open effortlessly. These features along with self-closing doors make this the ultimate choice in customer convenience. ABS sheet door liners resist water condensation with thermal efficiency.

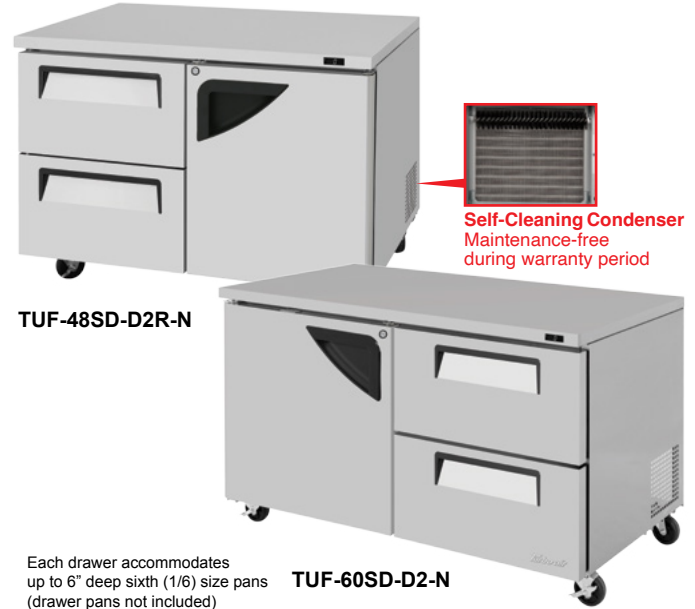

TUF-48SD-D2R-N

TUF-60SD-D2-N

Each drawer accommodates up to 6" deep sixth (1/6) size pans (drawer pans not included)

■ **Freezer holds -10°F ~ 0°F for the best in frozen food preservation**

■ **Each drawer accommodates up to 6" deep, two (2) 1/3 size pans or four (4) 1/6 size pans (drawer pans not included)**

■ **Standard features**

- Anti-corrosion coated evaporator
- Self-contained system
- 4" dia. swivel casters with locks on the front set

■ **Optional features**

- Legs available for all models: 6"
- Stainless steel single/double overshelf available
- Casters available for all models: 1", 2.5", 5"
- Back splash guard available

TUF MODELS SPECIFICATIONS

ELECTRICAL DATA	TUF-48SD-D2R-N	TUF-60SD-D2R-N	TUF-60SD-D2-N
Voltage	115/60/1	115/60/1	115/60/1
Plug Type	Ⓢ NEMA 5-15P	Ⓢ NEMA 5-15P	Ⓢ NEMA 5-15P
Full Load Amp.	8.0	8.0	4.8
Compressor HP	1/3	1/2	1/2
Cord Length (ft.)	10	10	10
Refrigerant	R-290	R-290	R-290
DIMENSIONAL DATA			
Net Capacity (cu. ft.)	12.2	17.2	17
Ext. Dimension (L x D x H†) (in.)	48 1/4 x 30 x 30	60 1/4 x 30 x 30	60 1/4 x 30 x 30
# of Doors	1	1	1
# of Drawers	2	2	2
# of Shelves	1	1	1
Shelf Size (L x D) (in.)	22 x 17	27 x 17	27 x 17
Net Weight (lbs.)	231	250	250
Gross Weight (lbs.)	253	288	288

Design and specifications subject to change without notice. Most updated spec sheets are available at www.turboairinc.com.

Actual shipping weight may differ due to extra packing materials for product protection.

* Depth does not include 1" and 1-1/4" (TUF-60SD-D2-N) for rear spacers. † Height does not include 5" and 4-3/4" (TUF-60SD-D2-N) for caster height.

■ **WARRANTY: 5 Year Parts and Labor Warranty, 7 Year Compressor Warranty**

UNDERCOUNTER REF. - FRONT BREATHING AIRFLOW NATURAL Refrigerant

Self-Cleaning Condenser Equipped Units

■ **Self-Cleaning Condenser (Patented)**

The accumulation of dust in the condenser can cause the failure or breakdown of refrigerators. Refrigerators run normally until they reach a certain level of accumulation. At some point, when they are over the limit, their performance drops quickly resulting in damage to, or disposal of the stored products inside. The Self-Cleaning Condenser device keeps the condenser clean and prevents system failure by automatically brushing daily.

■ **Digital temperature control & monitor system**

Keeps food products safe by maintaining constant temperatures. External digital display allows for easy monitoring.

■ **Front Breathing airflow**

Front Breathing airflow is designed to draw in air and discharge from the front, allowing units to run at high efficiency in tight spaces and eliminates the need for surrounding clearances.

■ **Hydrocarbon refrigerants (R-290 / R-600a)**

With innovative and eco-friendly technology, Turbo Air brings you hydrocarbon refrigerators designed to meet DOE's Energy Conservation Standards in 2017 and to use EPA's SNAP Program approved HC refrigerants. Hydrocarbon refrigerants do not deplete the ozone layer and have very low contribution to global warming (ODP-0, GWP-3).

■ **Stainless steel cabinet construction**

The Turbo Air Super Deluxe model boasts a stainless steel interior and exterior (galvanized steel back & bottom). It guarantees the utmost in cleanliness and long product life. The Super Deluxe adds a touch of style to the most refined setting.

■ **Sturdy, clean stainless steel shelving**

Shelves are the most important part of cleanliness as they come in direct contact with food. After a while, PVC coated wire shelves may peel, rust and lead to unsanitary conditions. The Super Deluxe series uniquely provides stainless steel shelving.

■ **Ergonomically designed doors**

Customers' fatigue fades away with easy grip handles and doors that open effortlessly. These features along with self-closing doors make this the ultimate choice in customer convenience. ABS sheet door liners resist water condensation with thermal efficiency.

■ **Refrigerator holds 33°F ~ 38°F for the best in food preservation**

■ **Standard features**

- Anti-corrosion coated evaporator
- Self-contained system
- 4" dia. swivel casters with locks on the front set
- High-density polyurethane insulation
- Door locks



TUR-28SD-FB-N

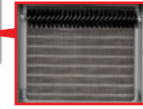

Self-Cleaning Condenser
Maintenance-free during warranty period

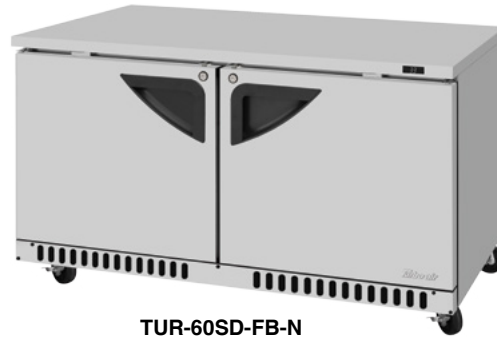

TUR-60SD-FB-N

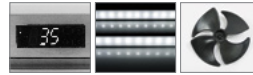

LED interior lighting & fan control

Energy efficient LED lighting lights every corner, making items easy to find. Fan control function automatically shuts off the fan when the door is open, which prevents hot air from being drawn in, thus maintaining the cool inner temperature.

■ **Optional features**

- Legs available for all models: 6"
- Stainless steel single/double overshelf available (except TUR-28SD-FB-N)
- Casters available for all models: 1" / 2.5"(except TUR-28SD-FB-N), 5"
- Back splash guard available

TUR MODELS SPECIFICATIONS

ELECTRICAL DATA	TUR-28SD-FB-N	TUR-48SD-FB-N	TUR-60SD-FB-N	TUR-72SD-FB-N
Voltage	115/60/1	115/60/1	115/60/1	115/60/1
Plug Type	Ⓜ NEMA 5-15P	Ⓜ NEMA 5-15P	Ⓜ NEMA 5-15P	Ⓜ NEMA 5-15P
Full Load Amp.	6.6	6.5	8.9	9.9
Compressor HP	1/5	1/5	1/5	1/5
Cord Length (ft.)	10	10	10	10
Refrigerant	R-290	R-290	R-290	R-290
DIMENSIONAL DATA				
Net Capacity (cu. ft.)	6.5	11.1	14.8	17.6
Ext. Dimension (L x D x H†) (in.)	27 1/2 x 30 x 30 1/2	48 1/4 x 30 x 30 1/2	60 1/4 x 30 x 30 1/2	72 5/8 x 30 x 30 1/2
# of Doors	1	2	2	3
# of Shelves	1	2	2	3
Shelf Size (L x D) (in.)	22 1/2 x 17	21 x 17	27 x 17	21 x 17 (L/R), 23 x 17 (M)
Net Weight (lbs.)	170	243	321	356
Gross Weight (lbs.)	195	273	352	396

Design and specifications subject to change without notice. Most updated spec sheets are available at www.turboairinc.com.

Actual shipping weight may differ due to extra packing materials for product protection.

† Height does not include 4-1/2" for caster height.

■ **WARRANTY: 5 Year Parts and Labor Warranty, 7 Year Compressor Warranty**

UNDERCOUNTER FREEZERS - FRONT BREATHING AIRFLOW

Self-Cleaning Condenser Equipped Units

Self-Cleaning Condenser (Patented)

The accumulation of dust in the condenser can cause the failure or breakdown of refrigerators. Refrigerators run normally until they reach a certain level of accumulation. At some point, when they are over the limit, their performance drops quickly resulting in damage to, or disposal of the stored products inside. The Self-Cleaning Condenser device keeps the condenser clean and prevents system failure by automatically brushing daily.

Digital temperature control & monitor system

Keeps food products safe by maintaining constant temperatures. External digital display allows for easy monitoring.

Front Breathing airflow

Front Breathing airflow is designed to draw in air and discharge from the front, allowing units to run at high efficiency in tight spaces and eliminates the need for surrounding clearances.

Hydrocarbon refrigerants (R-290 / R-600a)

With innovative and eco-friendly technology, Turbo Air brings you hydrocarbon refrigerators designed to meet DOE's Energy Conservation Standards in 2017 and to use EPA's SNAP Program approved HC refrigerants. Hydrocarbon refrigerants do not deplete the ozone layer and have very low contribution to global warming (ODP-0, GWP-3).

Stainless steel cabinet construction

The Turbo Air Super Deluxe model boasts a stainless steel interior and exterior (galvanized steel back & bottom). It guarantees the utmost in cleanliness and long product life. The Super Deluxe adds a touch of style to the most refined setting.

Sturdy, clean stainless steel shelving

Shelves are the most important part of cleanliness as they come in direct contact with food. After a while, PVC coated wire shelves may peel, rust and lead to unsanitary conditions. The Super Deluxe series uniquely provides stainless steel shelving.

Ergonomically designed doors

Customers' fatigue fades away with easy grip handles and doors that open effortlessly. These features along with self-closing doors make this the ultimate choice in customer convenience. ABS sheet door liners resist water condensation with thermal efficiency.

Freezer holds -10°F ~ 0°F for the best in food preservation

Standard features

- Anti-corrosion coated evaporator
- Self-contained system
- 4" dia. swivel casters with locks on the front set
- High-density polyurethane insulation
- Door locks

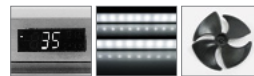

LED interior lighting & fan control

Energy efficient LED lighting lights every corner, making items easy to find. Fan control function automatically shuts off the fan when the door is open, which prevents hot air from being drawn in, thus maintaining the cool inner temperature.

Optional features

- Legs available for all models: 6"
- Stainless steel single/double overshef available (except TUF-28SD-FB-N)
- Casters available for all models: 1" / 2.5" (except TUF-28SD-FB-N), 5"
- Back splash guard available

TUR MODELS SPECIFICATIONS

ELECTRICAL DATA	TUF-28SD-FB-N	TUF-48SD-FB-N	TUF-60SD-FB-N
Voltage	115/60/1	115/60/1	115/60/1
Plug Type	Ⓜ NEMA 5-15P	Ⓜ NEMA 5-15P	Ⓜ NEMA 5-15P
Full Load Amp.	4.5	8	8
Compressor HP	1/4	1/3	1/2
Cord Length (ft.)	10	10	10
Refrigerant	R-290	R-290	R-290
DIMENSIONAL DATA			
Net Capacity (cu. ft.)	11.1	14.8	17.6
Ext. Dimension (L x D x H†) (in.)	27 1/2 x 30 x 30 1/2	48 1/4 x 30 x 30 1/2	60 1/4 x 30 x 30 1/2
# of Doors	1	2	2
# of Shelves	1	2	2
Shelf Size (L x D) (in.)	22 1/2 x 17	21 x 17	27 x 17
Net Weight (lbs.)	170	243	321
Gross Weight (lbs.)	195	273	352

Design and specifications subject to change without notice. Most updated spec sheets are available at www.turboairinc.com.

Actual shipping weight may differ due to extra packing materials for product protection.

† Height does not include 4-1/2" for caster height.

WARRANTY: 5 Year Parts and Labor Warranty, 7 Year Compressor Warranty

UNDERCOUNTER REF. - FRONT BREATHING AIRFLOW/DRAWERS

Self-Cleaning Condenser Equipped Units

■ **Self-Cleaning Condenser (Patented)**

The accumulation of dust in the condenser can cause the failure or breakdown of refrigerators. Refrigerators run normally until they reach a certain level of accumulation. At some point, when they are over the limit, their performance drops quickly resulting in damage to, or disposal of the stored products inside. The Self-Cleaning Condenser device keeps the condenser clean and prevents system failure by automatically brushing daily.

■ **Digital temperature control & monitor system**

Keeps food products safe by maintaining constant temperatures. External digital display allows for easy monitoring.

■ **Front Breathing airflow**

Front Breathing airflow is designed to draw in air and discharge from the front, allowing units to run at high efficiency in tight spaces and eliminates the need for surrounding clearances.

■ **Hydrocarbon refrigerants (R-290)**

With innovative and eco-friendly technology, Turbo Air brings you hydrocarbon refrigerators designed to meet DOE's Energy Conservation Standards in 2017 and to use EPA's SNAP Program approved HC refrigerants. Hydrocarbon refrigerants do not deplete the ozone layer and have very low contribution to global warming (ODP-0, GWP-3).

■ **Stainless steel cabinet construction**

The Turbo Air Super Deluxe model boasts a stainless steel interior and exterior (galvanized steel back & bottom). It guarantees the utmost in cleanliness and long product life. The Super Deluxe adds a touch of style to the most refined setting.

■ **Sturdy, clean stainless steel shelving**

Shelves are the most important part of cleanliness as they come in direct contact with food. After a while, PVC coated wire shelves may peel, rust and lead to unsanitary conditions. The Super Deluxe series uniquely provides stainless steel shelving (only TUR-48SD-D2R(L)-FB-N).

■ **Ergonomically designed doors**

Customers' fatigue fades away with easy grip handles and doors that open effortlessly. These features along with self-closing doors make this the ultimate choice in customer convenience. ABS sheet door liners resist water condensation with thermal efficiency (only TUR-48SD-D2R(L)-FB-N).

■ **High-density polyurethane insulation**

The entire cabinet structure and solid doors are foamed-in-place using high density, CFC free polyurethane insulation.

■ **Refrigerator holds 33°F ~ 38°F for the best in food preservation**



TUR-48SD-D2R-FB-N
Each drawer accommodates up to 6" deep sixth (1/6) size pans

TUR-28SD-D2-FB-N

Self-Cleaning Condenser
Maintenance-free during warranty period

■ **Standard features**

- Anti-corrosion coated evaporator
- Self-contained system
- 4" dia. swivel casters with locks on the front set

■ **Optional features**

- Legs available for all models: 6"
- Stainless steel single/double overshef available (except TUR-28SD-D2-FB-N)
- Casters available for all models: 1" / 2.5" (except TUR-28SD-D2-FB-N), 5"
- Back splash guard available

TUR MODELS SPECIFICATIONS

ELECTRICAL DATA	TUR-28SD-D2-FB-N	TUR-48SD-D2R(L)-FB-N	TUR-48SD-D4-FB-N
Voltage	115/60/1	115/60/1	115/60/1
Plug Type	Ⓢ NEMA 5-15P	Ⓢ NEMA 5-15P	Ⓢ NEMA 5-15P
Full Load Amp.	4.5	8	8
Compressor HP	1/4	1/3	1/3
Cord Length (ft.)	10	10	10
Refrigerant	R-290	R-290	R-290
DIMENSIONAL DATA			
Net Capacity (cu. ft.)	11.1	14.8	14.8
Ext. Dimension (L x D x H†) (in.)	27 1/2 x 30 x 30 1/2	48 1/4 x 30 x 30 1/2	48 1/4 x 30 x 30 1/2
# of Doors	-	1	1
# of Drawers	2	2	2
# of Shelves	-	1	-
Shelf Size (L x D) (in.)	-	21 x 17	-
Net Weight (lbs.)	170	243	253
Gross Weight (lbs.)	195	273	283

Design and specifications subject to change without notice. Most updated spec sheets are available at www.turboairinc.com.

Actual shipping weight may differ due to extra packing materials for product protection.

† Height does not include 4-1/2" for caster height.

■ **WARRANTY: 5 Year Parts and Labor Warranty, 7 Year Compressor Warranty**

UNDERCOUNTER REF. - FRONT BREATHING AIRFLOW/DRAWERS

Self-Cleaning Condenser Equipped Units

■ **Self-Cleaning Condenser (Patented)**

The accumulation of dust in the condenser can cause the failure or breakdown of refrigerators. Refrigerators run normally until they reach a certain level of accumulation. At some point, when they are over the limit, their performance drops quickly resulting in damage to, or disposal of the stored products inside. The Self-Cleaning Condenser device keeps the condenser clean and prevents system failure by automatically brushing daily.

■ **Digital temperature control & monitor system**

Keeps food products safe by maintaining constant temperatures. External digital display allows for easy monitoring.

■ **Front Breathing airflow**

Front Breathing airflow is designed to draw in air and discharge from the front, allowing units to run at high efficiency in tight spaces and eliminates the need for surrounding clearances.

■ **Hydrocarbon refrigerants (R-290)**

With innovative and eco-friendly technology, Turbo Air brings you hydrocarbon refrigerators designed to meet DOE's Energy Conservation Standards in 2017 and to use EPA's SNAP Program approved HC refrigerants. Hydrocarbon refrigerants do not deplete the ozone layer and have very low contribution to global warming (ODP-0, GWP-3).

■ **Stainless steel cabinet construction**

The Turbo Air Super Deluxe model boasts a stainless steel interior and exterior (galvanized steel back & bottom). It guarantees the utmost in cleanliness and long product life. The Super Deluxe adds a touch of style to the most refined setting.

■ **Sturdy, clean stainless steel shelving**

Shelves are the most important part of cleanliness as they come in direct contact with food. After a while, PVC coated wire shelves may peel, rust and lead to unsanitary conditions. The Super Deluxe series uniquely provides stainless steel shelving (only TUR-60SD-D2R(L)-FB-N, TUR-72SD-D2R(L)-FB-N).

■ **Ergonomically designed doors**

Customers' fatigue fades away with easy grip handles and doors that open effortlessly. These features along with self-closing doors make this the ultimate choice in customer convenience. ABS sheet door liners resist water condensation with thermal efficiency (only TUR-60SD-D2R(L)-FB-N, TUR-72SD-D4R(L)-FB-N).

■ **High-density polyurethane insulation**

The entire cabinet structure and solid doors are foamed-in-place using high density, CFC free polyurethane insulation.

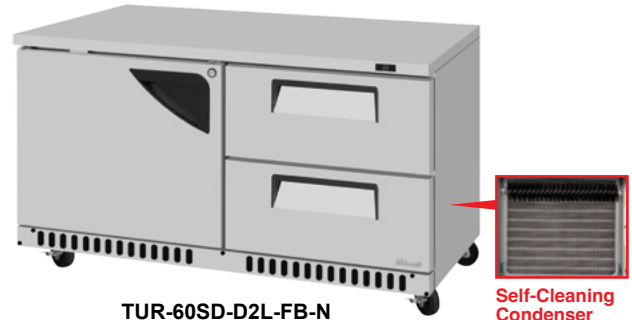

TUR-60SD-D2L-FB-N

Each drawer accommodates up to 6" deep sixth (1/6) size pans

Self-Cleaning Condenser
Maintenance-free during warranty period

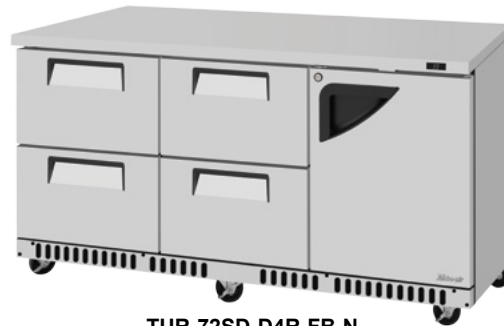

TUR-72SD-D4R-FB-N

■ **Refrigerator holds 33°F ~ 38°F for the best in food preservation**

■ **Standard features**

- Anti-corrosion coated evaporator
- Self-contained system
- 4" dia. swivel casters with locks on the front set

■ **Optional features**

- Legs available for all models: 6"
- Stainless steel single/double overself available
- Casters available for all models: 1", 2.5", 5"
- Back splash guard available

TUR MODELS SPECIFICATIONS

ELECTRICAL DATA	TUR-60SD-D2R(L)-FB-N	TUR-60SD-D4-FB-N	TUR-72SD-D4R(L)-FB-N	TUR-72SD-D6-FB-N
Voltage	115/60/1	115/60/1	115/60/1	115/60/1
Plug Type	Ⓢ NEMA 5-15P	Ⓢ NEMA 5-15P	Ⓢ NEMA 5-15P	Ⓢ NEMA 5-15P
Full Load Amp.	8	8	9.9	9.9
Compressor HP	1/2	1/2	1/5	1/5
Cord Length (ft.)	10	10	10	10
Refrigerant	R-290	R-290	R-290	R-290
DIMENSIONAL DATA				
Net Capacity (cu. ft.)	17.6	17.6	17.6	17.6
Ext. Dimension (L x D x H†) (in.)	60 1/4 x 30 x 30 1/2	60 1/4 x 30 x 30 1/2	72 5/8 x 30 x 30 1/2	72 5/8 x 30 x 30 1/2
# of Doors	1	-	1	-
# of Drawers	2	4	4	6
# of Shelves	1	-	1	-
Shelf Size (L x D) (in.)	27 x 17	-	21 x 17	-
Net Weight (lbs.)	321	331	356	366
Gross Weight (lbs.)	352	362	396	406

Design and specifications subject to change without notice. Most updated spec sheets are available at www.turboairinc.com.

Actual shipping weight may differ due to extra packing materials for product protection.

† Height does not include 4-1/2" for caster height.

■ **WARRANTY: 5 Year Parts and Labor Warranty, 7 Year Compressor Warranty**

UNDERCOUNTER FREEZERS - FRONT BREATHING AIRFLOW/DRAWERS

Self-Cleaning Condenser Equipped Units

■ **Self-Cleaning Condenser (Patented)**

The accumulation of dust in the condenser can cause the failure or breakdown of refrigerators. Refrigerators run normally until they reach a certain level of accumulation. At some point, when they are over the limit, their performance drops quickly resulting in damage to, or disposal of the stored products inside. The Self-Cleaning Condenser device keeps the condenser clean and prevents system failure by automatically brushing daily.

■ **Digital temperature control & monitor system**

Keeps food products safe by maintaining constant temperatures. External digital display allows for easy monitoring.

■ **Front Breathing airflow**

Front Breathing airflow is designed to draw in air and discharge from the front, allowing units to run at high efficiency in tight spaces and eliminates the need for surrounding clearances.

■ **Hydrocarbon refrigerants (R-290)**

With innovative and eco-friendly technology, Turbo Air brings you hydrocarbon refrigerators designed to meet DOE's Energy Conservation Standards in 2017 and to use EPA's SNAP Program approved HC refrigerants. Hydrocarbon refrigerants do not deplete the ozone layer and have very low contribution to global warming (ODP-0, GWP-3).

■ **Stainless steel cabinet construction**

The Turbo Air Super Deluxe model boasts a stainless steel interior and exterior (galvanized steel back & bottom). It guarantees the utmost in cleanliness and long product life. The Super Deluxe adds a touch of style to the most refined setting.

■ **Sturdy, clean stainless steel shelving**

Shelves are the most important part of cleanliness as they come in direct contact with food. After a while, PVC coated wire shelves may peel, rust and lead to unsanitary conditions. The Super Deluxe series uniquely provides stainless steel shelving (only TUF-48SD-D2R(L)-FB-N, TUF-60SD-D2R(L)-FB-N).

■ **Ergonomically designed doors**

Customers' fatigue fades away with easy grip handles and doors that open effortlessly. These features along with self-closing doors make this the ultimate choice in customer convenience. ABS sheet door liners resist water condensation with thermal efficiency (only TUF-48SD-D2R(L)-FB-N, TUF-60SD-D2R(L)-FB-N).

■ **High-density polyurethane insulation**

The entire cabinet structure and solid doors are foamed-in-place using high density, CFC free polyurethane insulation.



■ **Freezer holds -10°F ~ 0°F for the best in food preservation**

■ **Standard features**

- Anti-corrosion coated evaporator
- Self-contained system
- 4" dia. swivel casters with locks on the front set

■ **Optional features**

- Legs available for all models: 6"
- Stainless steel single/double overshelf available (except TUF-28SD-D2-FB-N)
- Casters available for all models: 1" / 2.5"(except TUF-28SD-D2-FB-N), 5"
- Back splash guard available

TUF MODELS SPECIFICATIONS

ELECTRICAL DATA	TUF-28SD-D2-FB-N	TUF-48SD-D2R(L)-FB-N	TUF-48SD-D4-FB-N	TUF-60SD-D2R(L)-FB-N	TUF-60SD-D4-FB-N
Voltage	115/60/1	115/60/1	115/60/1	115/60/1	115/60/1
Plug Type	Ⓢ NEMA 5-15P	Ⓢ NEMA 5-15P	Ⓢ NEMA 5-15P	Ⓢ NEMA 5-15P	Ⓢ NEMA 5-15P
Full Load Amp.	4.5	8	8	8	8
Compressor HP	1/4	1/3	1/3	1/2	1/2
Cord Length (ft.)	10	10	10	10	10
Refrigerant	R-290	R-290	R-290	R-290	R-290
DIMENSIONAL DATA					
Net Capacity (cu. ft.)	11.1	14.8	14.8	17.6	17.6
Ext. Dimension (L x D x H †) (in.)	27 1/2 x 30 x 30 1/2	48 1/4 x 30 x 30 1/2	48 1/4 x 30 x 30 1/2	60 1/4 x 30 x 30 1/2	60 1/4 x 30 x 30 1/2
# of Doors	-	1	-	1	-
# of Drawers	2	2	4	2	4
# of Shelves	-	1	-	1	-
Shelf Size (L x D) (in.)	-	21 x 17	-	27 x 17	-
Net Weight (lbs.)	170	243	253	321	331
Gross Weight (lbs.)	195	273	283	352	362

Design and specifications subject to change without notice. Most updated spec sheets are available at www.turboairinc.com.

Actual shipping weight may differ due to extra packing materials for product protection.

† Height does not include 4-1/2" for caster height.

■ **WARRANTY: 5 Year Parts and Labor Warranty, 7 Year Compressor Warranty**

UNDERCOUNTER REFRIGERATORS NATURAL Refrigerant

Self-Cleaning Condenser Equipped Units

■ **Self-Cleaning Condenser (Patented)**

The accumulation of dust in the condenser can cause the failure or breakdown of refrigerators. Refrigerators run normally until they reach a certain level of accumulation. At some point, when they are over the limit, their performance drops quickly resulting in damage to, or disposal of the stored products inside. The Self-Cleaning Condenser device keeps the condenser clean and prevents system failure by automatically brushing daily.

■ **Digital temperature control & monitor system**

Keeps food products safe by maintaining constant temperatures. External digital display allows for easy monitoring.

■ **Hydrocarbon refrigerants (R-290 / R-600a)**

With innovative and eco-friendly technology, Turbo Air brings you hydrocarbon refrigerators designed to meet DOE's Energy Conservation Standards in 2017 and to use EPA's SNAP Program approved HC refrigerants. Hydrocarbon refrigerants do not deplete the ozone layer and have very low contribution to global warming (ODP-0, GWP-3).

■ **Stainless steel exterior**

The Turbo Air M3 model boasts a stainless steel exterior (galvanized steel back and bottom). Interior is stainless steel floor with AL sides and back. It guarantees the utmost in cleanliness and long product life. The M3 model adds a touch of style to the most refined setting.

■ **High-density polyurethane insulation**

The entire cabinet structure and solid doors are foamed-in-place using high density, CFC free polyurethane insulation.

■ **Ergonomically designed doors**

Customers' fatigue fades away with easy grip handles and doors that open effortlessly. These features along with self-closing doors make this the ultimate choice in customer convenience. ABS sheet door liners resist water condensation with thermal efficiency.

■ **Field reversible hinge (MUR-28-N)**

■ **Adjustable, heavy duty, PE (polyethylene) coated wire shelves**

■ **Refrigerator holds 33°F ~ 38°F for the best in food preservation**

■ **Standard features**

- Anti-corrosion coated evaporator
- Self-contained system
- 4" dia. swivel casters with locks on the front set
- Door locks

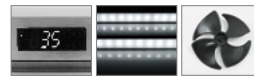

LED interior lighting & fan control

Energy efficient LED lighting lights every corner, making items easy to find. Fan control function automatically shuts off the fan when the door is open, which prevents hot air from being drawn in, thus maintaining the cool inner temperature.

■ **Optional features**

- Legs available for all models: 6"
- Stainless steel single/double overshef available (except MUR-28-N, single not applicable to MUR-36-N6)
- Casters available for all models: 1", 2.5", 5"
- Back splash guard available

MUR MODELS SPECIFICATIONS

ELECTRICAL DATA	MUR-28-N	MUR-36-N6	MUR-48-N	MUR-60-N	MUR-72-N
Voltage	115/60/1	115/60/1	115/60/1	115/60/1	115/60/1
Plug Type	Ⓢ NEMA 5-15P	Ⓢ NEMA 5-15P	Ⓢ NEMA 5-15P	Ⓢ NEMA 5-15P	Ⓢ NEMA 5-15P
Full Load Amp.	2.2	2.3	2.5	2.4	2.5
Compressor HP	1/6	1/5	1/6	1/6	1/6
Cord Length (ft.)	9	9	9	9	9
Refrigerant	R-290	R-600a	R-290	R-290	R-290
DIMENSIONAL DATA					
Net Capacity (cu. ft.)	6.8	9	12.2	17	18.8
Ext. Dimension (L x D x H) (in.)	27 1/2 x 30* x 30 5/8 †	36 3/8 x 30* x 30 5/8 †	48 1/4 x 30* x 30 5/8 †	60 1/4 x 30* x 30 5/8 †	72 5/8 x 30* x 30 1/2 ‡
# of Doors	1	2	2	2	3
# of Shelves	1	2	2	2	3
Shelf Size (L x D) (in.)	22 1/2 x 17	15 x 17	21 x 17	27 x 17	21 x 17 (L/R), 23 x 17 (M)
Net Weight (lbs.)	146	184	229	260	303
Gross Weight (lbs.)	163	199	246	282	352

Design and specifications subject to change without notice. Most updated spec sheets are available at www.turboairinc.com.

Actual shipping weight may differ due to extra packing materials for product protection.

* Depth does not include 1" for rear spacers. † Height does not include 5" for caster height. ‡ Height does not include 4-3/4" for caster height.

■ **WARRANTY: 5 Year Parts and Labor Warranty, 7 Year Compressor Warranty**

UNDERCOUNTER REFRIGERATORS - LOW BOY NATURAL Refrigerant

Self-Cleaning Condenser Equipped Units

■ **Self-Cleaning Condenser (Patented)**

The accumulation of dust in the condenser can cause the failure or breakdown of refrigerators. Refrigerators run normally until they reach a certain level of accumulation. At some point, when they are over the limit, their performance drops quickly resulting in damage to, or disposal of the stored products inside. The Self-Cleaning Condenser device keeps the condenser clean and prevents system failure by automatically brushing daily.

■ **Digital temperature control & monitor system**

Keeps food products safe by maintaining constant temperatures. External digital display allows for easy monitoring.

■ **Hydrocarbon refrigerants (R-600a)**

With innovative and eco-friendly technology, Turbo Air brings you hydrocarbon refrigerators designed to meet DOE's Energy Conservation Standards in 2017 and to use EPA's SNAP Program approved HC refrigerants. Hydrocarbon refrigerants do not deplete the ozone layer and have very low contribution to global warming (ODP-0, GWP-3).

■ **Stainless steel exterior**

The Turbo Air M3 model boasts a stainless steel exterior (galvanized steel back and bottom). Interior is stainless steel floor with AL sides and back. It guarantees the utmost in cleanliness and long product life. The M3 model adds a touch of style to the most refined setting.

■ **High-density polyurethane insulation**

The entire cabinet structure and solid doors are foamed-in-place using high density, CFC free polyurethane insulation.

■ **Ergonomically designed doors**

Customers' fatigue fades away with easy grip handles and doors that open effortlessly. These features along with self-closing doors make this the ultimate choice in customer convenience. ABS sheet door liners resist water condensation with thermal efficiency.

■ **Field reversible hinge (MUR-28L-N6)**

■ **Adjustable, heavy duty, PE (polyethylene) coated wire shelves**

■ **Refrigerator holds 33°F ~ 38°F for the best in food preservation**

■ **Standard features**

- Anti-corrosion coated evaporator
- Self-contained system
- 2.5" dia. swivel casters with locks on the front set
- Door locks

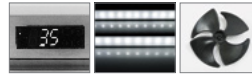

LED interior lighting & fan control

Energy efficient LED lighting lights every corner, making items easy to find. Fan control function automatically shuts off the fan when the door is open, which prevents hot air from being drawn in, thus maintaining the cool inner temperature.

■ **Optional features**

- Legs available for all models: 6"
- Stainless steel double overshef available (except MUR-28L-N6)
- Casters available for all models: 1", 4", 5"
- Back splash guard available

MUR-L MODELS SPECIFICATIONS

ELECTRICAL DATA	MUR-28L-N6	MUR-36L-N6
Voltage	115/60/1	115/60/1
Plug Type	Ⓜ NEMA 5-15P	Ⓜ NEMA 5-15P
Full Load Amp.	2.1	6.1
Compressor HP	1/6	1/5
Cord Length (ft.)	9	9
Refrigerant	R-600a	R-600a
DIMENSIONAL DATA		
Net Capacity (cu. ft.)	6.18	8.36
Ext. Dimension (L x D* x H†) (in.)	27 1/2 x 30 x 27 5/8	36 3/8 x 30 x 27 5/8
# of Doors	1	2
# of Shelves	1	2
Shelf Size (L x D) (in.)	22 1/2 x 17	15 x 17
Net Weight (lbs.)	140	160
Gross Weight (lbs.)	163	187

Design and specifications subject to change without notice. Most updated spec sheets are available at www.turboairinc.com.

Actual shipping weight may differ due to extra packing materials for product protection.

* Depth does not include 1" for rear spacers. † Height does not include 3-1/8" for caster height.

■ **WARRANTY: 5 Year Parts and Labor Warranty, 7 Year Compressor Warranty**

UNDERCOUNTER FREEZERS NATURAL Refrigerant

Self-Cleaning Condenser Equipped Units

■ **Self-Cleaning Condenser (Patented)**

The accumulation of dust in the condenser can cause the failure or breakdown of refrigerators. Refrigerators run normally until they reach a certain level of accumulation. At some point, when they are over the limit, their performance drops quickly resulting in damage to, or disposal of the stored products inside. The Self-Cleaning Condenser device keeps the condenser clean and prevents system failure by automatically brushing daily.

■ **Digital temperature control & monitor system**

Keeps food products safe by maintaining constant temperatures. External digital display allows for easy monitoring.

■ **Hydrocarbon refrigerants (R-290)**

With innovative and eco-friendly technology, Turbo Air brings you hydrocarbon refrigerators designed to meet DOE's Energy Conservation Standards in 2017 and to use EPA's SNAP Program approved HC refrigerants. Hydrocarbon refrigerants do not deplete the ozone layer and have very low contribution to global warming (ODP-0, GWP-3).

■ **Stainless steel exterior**

The Turbo Air M3 model boasts a stainless steel exterior (galvanized steel back and bottom). Interior is stainless steel floor with AL sides and back. It guarantees the utmost in cleanliness and long product life. The M3 model adds a touch of style to the most refined setting.

■ **High-density polyurethane insulation**

The entire cabinet structure and solid doors are foamed-in-place using high density, CFC free polyurethane insulation.

■ **Ergonomically designed doors**

Customers' fatigue fades away with easy grip handles and doors that open effortlessly. These features along with self-closing doors make this the ultimate choice in customer convenience. ABS sheet door liners resist water condensation with thermal efficiency.

■ **Field reversible hinge (MUF-28-N)**

■ **Adjustable, heavy duty, PE (polyethylene) coated wire shelves**

■ **Freezer holds -10°F ~ 0°F for the best in frozen food preservation**

■ **Standard features**

- Anti-corrosion coated evaporator
- Self-contained system
- 4" dia. swivel casters with locks on the front set
- Door locks



MUF-60-N



MUF-36-N

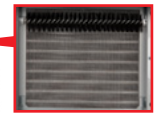

Self-Cleaning Condenser
Maintenance-free during warranty period

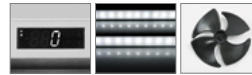

LED interior lighting & fan control

Energy efficient LED lighting lights every corner, making items easy to find. Fan control function automatically shuts off the fan when the door is open, which prevents hot air from being drawn in, thus maintaining the cool inner temperature.

■ **Optional features**

- Legs available for all models: 6"
- Stainless steel single/double overself available (except MUF-28-N, single not applicable to MUF-36-N)
- Casters available for all models: 1", 2.5", 5"
- Back splash guard available

MUF MODELS SPECIFICATIONS

ELECTRICAL DATA	MUF-28-N	MUF-36-N	MUF-48-N	MUF-60-N
Voltage	115/60/1	115/60/1	115/60/1	115/60/1
Plug Type	Ⓢ NEMA 5-15P	Ⓢ NEMA 5-15P	Ⓢ NEMA 5-15P	Ⓢ NEMA 5-15P
Full Load Amp.	1.9	3.0	2.8	4.8
Compressor HP	1/4+	1/3+	1/3	2/3
Cord Length (ft.)	9	9	9	9
Refrigerant	R-290	R-290	R-290	R-290
DIMENSIONAL DATA				
Net Capacity (cu. ft.)	6.8	9	12.2	17
Ext. Dimension (L x D* x H†) (in.)	27 1/2 x 30 x 30 5/8	36 3/8 x 30 x 30 5/8	48 1/4 x 30 x 30 5/8	60 1/4 x 30 x 30 5/8
# of Doors	1	2	2	2
# of Shelves	1	2	2	2
Shelf Size (L x D) (in.)	22 1/2 x 17	15 x 17	21 x 17	27 x 17
Net Weight (lbs.)	146	160	229	260
Gross Weight (lbs.)	163	187	246	282

Design and specifications subject to change without notice. Most updated spec sheets are available at www.turboairinc.com.

Actual shipping weight may differ due to extra packing materials for product protection.

* Depth does not include 1" for rear spacers. † Height does not include 5" for caster height.

■ **WARRANTY: 5 Year Parts and Labor Warranty, 7 Year Compressor Warranty**

UNDERCOUNTER REF. - SHALLOW DEPTH NATURAL Refrigerant

■ **Digital temperature control & monitor system**

Keeps food products safe by maintaining constant temperatures. External digital display allows for easy monitoring.

■ **Hydrocarbon refrigerants (R-600a)**

With innovative and eco-friendly technology, Turbo Air brings you hydrocarbon refrigerators designed to meet DOE's Energy Conservation Standards in 2017 and to use EPA's SNAP Program approved HC refrigerants. Hydrocarbon refrigerants do not deplete the ozone layer and have very low contribution to global warming (ODP-0, GWP-3).

■ **Stainless steel exterior**

The Turbo Air M3 model boasts a stainless steel exterior (galvanized steel back and bottom). Interior is stainless steel floor and back with AL sides. It guarantees the utmost in cleanliness and long product life. The M3 model adds a touch of style to the most refined setting.

■ **High-density polyurethane insulation**

The entire cabinet structure and solid doors are foamed-in-place using high density, CFC free polyurethane insulation.

■ **Ergonomically designed doors**

Customers' fatigue fades away with easy grip handles and doors that open effortlessly. These features along with self-closing doors make this the ultimate choice in customer convenience. ABS sheet door liners resist water condensation with thermal efficiency.

■ **Adjustable, heavy duty, PE (polyethylene) coated wire shelves**

■ **Refrigerator holds 33°F ~ 38°F for the best in food preservation**

■ **Standard features**

- Anti-corrosion coated evaporator
- Self-contained system
- 4" dia. swivel casters with locks on the front set

■ **Optional features**

- Legs available for all models: 6"
- Casters available for all models: 2.5", 5"
- Door locks available (except MUR-34S-N6) - extra lead time will apply

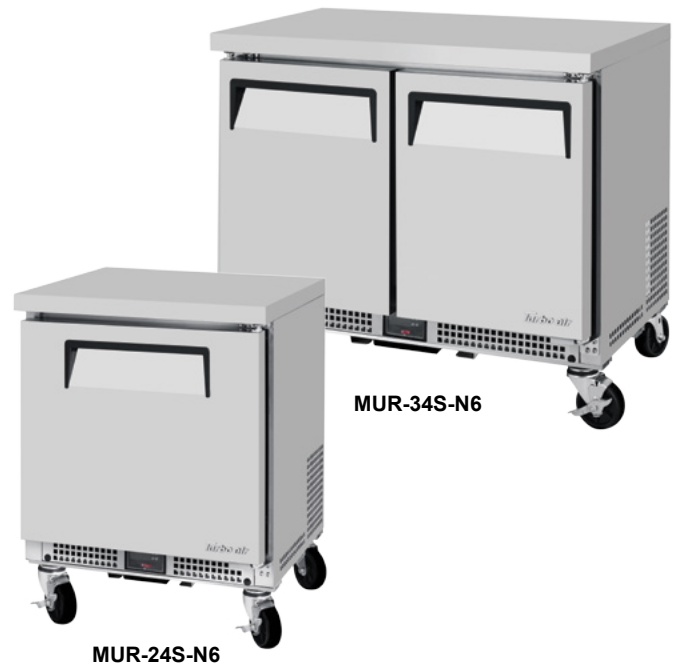

LED interior lighting & fan control

Energy efficient LED lighting lights every corner, making items easy to find. Fan control function automatically shuts off the fan when the door is open, which prevents hot air from being drawn in, thus maintaining the cool inner temperature.

MUR MODELS SPECIFICATIONS

ELECTRICAL DATA	MUR-20S-N6	MUR-24S-N6	MUR-27S-N6	MUR-34S-N6
Voltage	115/60/1	115/60/1	115/60/1	115/60/1
Plug Type	Ⓢ NEMA 5-15P	Ⓢ NEMA 5-15P	Ⓢ NEMA 5-15P	Ⓢ NEMA 5-15P
Full Load Amp.	2.3	2.4	2.4	2.6
Compressor HP	1/6	1/6	1/6	1/5
Cord Length (ft.)	9	9	9	9
Refrigerant	R-600a	R-600a	R-600a	R-600a
DIMENSIONAL DATA				
Net Capacity (cu. ft.)	2.29	2.86	3.28	4.27
Ext. Dimension (L x D* x H†) (in.)	20 x 22 1/2 x 25 5/8	24 x 22 1/2 x 25 5/8	27 x 22 1/2 x 25 5/8	34 x 22 1/2 x 25 5/8
# of Doors	1	1	1	2
# of Shelves	1	1	1	2
Shelf Size (L x D) (in.)	15 3/8 x 11 1/8	19 3/8 x 11 1/8	22 3/8 x 11 1/8	14 1/4 x 11 1/8
Net Weight (lbs.)	117	126	135	150
Gross Weight (lbs.)	127	137	147	161

Design and specifications subject to change without notice. Most updated spec sheets are available at www.turboairinc.com.

Actual shipping weight may differ due to extra packing materials for product protection.

* Depth does not include 3/4" for rear spacers. † Height does not include 5" for caster height.

■ **WARRANTY: 5 Year Parts and Labor Warranty, 7 Year Compressor Warranty**

GLASS DOOR UNDERCOUNTER REF. - SHALLOW DEPTH NATURAL Refrigerant

■ **Digital temperature control & monitor system**

Keeps food products safe by maintaining constant temperatures. External digital display allows for easy monitoring.

■ **Hydrocarbon refrigerants (R-600a)**

With innovative and eco-friendly technology, Turbo Air brings you hydrocarbon refrigerators designed to meet DOE's Energy Conservation Standards in 2017 and to use EPA's SNAP Program approved HC refrigerants. Hydrocarbon refrigerants do not deplete the ozone layer and have very low contribution to global warming (ODP-0, GWP-3).

■ **Stainless steel exterior**

The Turbo Air M3 model boasts a stainless steel exterior (galvanized steel back and bottom). Interior is stainless steel floor and back with AL sides. It guarantees the utmost in cleanliness and long product life. The M3 model adds a touch of style to the most refined setting.

■ **High-density polyurethane insulation**

The entire cabinet structure and solid doors are foamed-in-place using high density, CFC free polyurethane insulation.

■ **Ergonomically designed doors**

Customers' fatigue fades away with easy grip handles and doors that open effortlessly. These features along with self-closing doors make this the ultimate choice in customer convenience. ABS sheet door liners resist water condensation with thermal efficiency.

■ **Adjustable, heavy duty, PE (polyethylene) coated wire shelves**

■ **Refrigerator holds 33°F ~ 38°F for the best in food preservation**

■ **LED interior lighting**

■ **Standard features**

- Anti-corrosion coated evaporator
- Self-contained system
- 4" dia. swivel casters with locks on the front set
- Door locks

■ **Optional features**

- Legs available for all models: 6"
- Casters available for all models: 2.5", 5"



MUR-20SG-N6

MUR-S MODELS SPECIFICATIONS

ELECTRICAL DATA		MUR-20SG-N6
Voltage		115/60/1
Plug Type		Ⓜ NEMA 5-15P
Full Load Amp.		2.43
Compressor HP		1/6
Cord Length (ft.)		9
Refrigerant		R-600a
DIMENSIONAL DATA		
Net Capacity (cu. ft.)		2.29
Ext. Dimension (L x D [*] x H [†]) (in.)		20 x 22 ^{1/2} x 25 ^{5/8}
# of Doors		1
# of Shelves		1
Shelf Size (L x D) (in.)		15 ^{3/8} x 11 ^{1/8}
Net Weight (lbs.)		117
Gross Weight (lbs.)		127

Design and specifications subject to change without notice. Most updated spec sheets are available at www.turboairinc.com.

Actual shipping weight may differ due to extra packing materials for product protection.

* Depth does not include 1-3/4" for door handle & rear spacers. † Height does not include 5" for caster height.

■ **WARRANTY: 5 Year Parts and Labor Warranty, 7 Year Compressor Warranty**

UNDERCOUNTER REFRIGERATORS NATURAL Refrigerant

■ **Digital temperature control & monitor system**

Keeps food products safe by maintaining constant temperatures. External digital display allows for easy monitoring.

■ **Hydrocarbon refrigerants (R-600a)**

With innovative and eco-friendly technology, Turbo Air brings you hydrocarbon refrigerators designed to meet DOE's Energy Conservation Standards in 2017 and to use EPA's SNAP Program approved HC refrigerants. Hydrocarbon refrigerants do not deplete the ozone layer and have very low contribution to global warming (ODP-0, GWP-3).

■ **Side mount compressor unit**

With compressors positioned on the side of the unit, our refrigerators can now be serviced without being moved. Our front air intake feature also allows this model to be highly efficient in narrow spaces.

■ **Stainless steel exterior**

The Turbo Air J series boasts a stainless steel exterior (galvanized steel back and bottom). Interior is stainless steel floor with AL sides, back and AL door liners. It guarantees the utmost in cleanliness and long product life. The J series adds a touch of style to the most refined setting.

■ **Hot gas condensate system**

Through Turbo Air's creative innovation, the condensate system surfaces have been specially treated to resist corrosion. This not only increases efficiency without the risk of refrigerant leakage from corrosion, but also thoroughly prevents the overflow of condensate water.

■ **High-density polyurethane insulation**

The entire cabinet structure and solid doors are foamed-in-place using high density, CFC free polyurethane insulation.

■ **Ergonomically designed doors**

Customers' fatigue fades away with easy grip handles and doors that open effortlessly. These features along with self-closing doors make this the ultimate choice in customer convenience.

■ **Adjustable, heavy duty, PE (polyethylene) coated wire shelves**

■ **Easy open front grille with condenser cleaning brush kit**

Front grille cover is easily removable without any tools, which makes condenser cleaning easy and convenient at any time. Handy condenser cleaning brush is included inside the front grille cover.

■ **Refrigerator holds 33°F ~ 39°F for the best in food preservation**

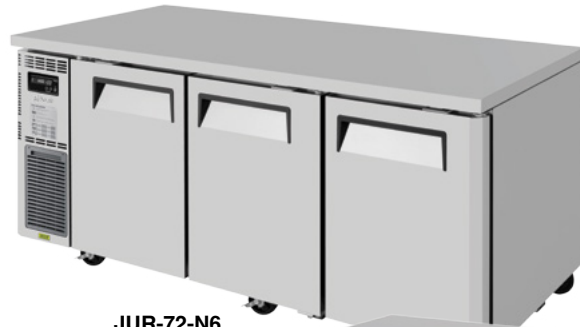

JUR-72-N6



JUR-48-N6

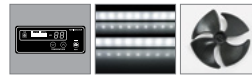

LED interior lighting & fan control

Energy efficient LED lighting lights every corner, making items easy to find. Fan control function automatically shuts off the fan when the door is open, which prevents hot air from being drawn in, thus maintaining the cool inner temperature.

■ **Standard features**

- Anti-corrosion coated evaporator
- Self-contained system
- 4" dia. swivel casters with locks on the front set

■ **Optional features**

- Casters available for all models: 1", 2.5", 5"
- Door locks available (extra lead time will apply)
- Legs available for all models: 6"

JUR MODELS SPECIFICATIONS

ELECTRICAL DATA	JUR-36-N6	JUR-48-N6	JUR-60-N6	JUR-72-N6
Voltage	115/60/1	115/60/1	115/60/1	115/60/1
Plug Type	Ⓜ NEMA 5-15P	Ⓜ NEMA 5-15P	Ⓜ NEMA 5-15P	Ⓜ NEMA 5-15P
Full Load Amp.	1.7	1.7	1.9	1.9
Compressor HP	1/6	1/5	1/5	1/5
Cord Length (ft.)	9	9	9	9
Refrigerant	R-600a	R-600a	R-600a	R-600a
DIMENSIONAL DATA				
Net Capacity (cu. ft.)	6.37	9.93	13.58	17.2
Ext. Dimension (L x D [†] x H [†]) (in.)	35 ³ / ₈ x 27 ¹ / ₂ x 28 ³ / ₄	47 ¹ / ₄ x 27 ¹ / ₂ x 28 ³ / ₄	59 x 27 ¹ / ₂ x 28 ³ / ₄	70 ⁷ / ₈ x 27 ¹ / ₂ x 28 ³ / ₄
# of Doors	1	2	2	3
# of Shelves	1	2	2	3
Shelf Size (L x D) (in.)	19 ¹ / ₂ x 20 ¹ / ₄	15 ¹ / ₂ x 20 ¹ / ₄	21 ³ / ₈ x 20 ¹ / ₄	17 ¹ / ₂ x 20 ¹ / ₄ (L/R), 19 ¹ / ₂ x 20 ¹ / ₄ (M)
Net Weight (lbs.)	157	184	205	239
Gross Weight (lbs.)	190	222	250	295

Design and specifications subject to change without notice. Most updated spec sheets are available at www.turboairinc.com.

Actual shipping weight may differ due to extra packing materials for product protection.

* Depth does not include 1-1/4" for rear spacers. † Height does not include 4-3/4" for caster height.

■ **WARRANTY: 2 Year Parts and Labor Warranty, 5 Year Compressor Warranty**

GLASS DOOR UNDERCOUNTER REF. NATURAL Refrigerant

■ **Digital temperature control & monitor system**

Keeps food products safe by maintaining constant temperatures. External digital display allows for easy monitoring.

■ **Hydrocarbon refrigerants (R-290)**

With innovative and eco-friendly technology, Turbo Air brings you hydrocarbon refrigerators designed to meet DOE's Energy Conservation Standards in 2017 and to use EPA's SNAP Program approved HC refrigerants. Hydrocarbon refrigerants do not deplete the ozone layer and have very low contribution to global warming (ODP-0, GWP-3).

■ **Side mount compressor unit**

With compressors positioned on the side of the unit, our refrigerators can now be serviced without being moved. Our front air intake feature also allows this model to be highly efficient in narrow spaces.

■ **Stainless steel exterior**

The Turbo Air J series boasts a stainless steel exterior with glass doors & AL frames (galvanized steel back and bottom). Interior is stainless steel floor with AL sides and back. It guarantees the utmost in cleanliness and long product life. The J series adds a touch of style to the most refined setting.

■ **High-density polyurethane insulation**

The entire cabinet structure and solid doors are foamed-in-place using high density, CFC free polyurethane insulation.

■ **Ergonomically designed doors**

Customers' fatigue fades away with easy grip handles and doors that open effortlessly. These features along with self-closing doors make this the ultimate choice in customer convenience.

■ **Adjustable, heavy duty, PE (polyethylene) coated wire shelves**

■ **Easy open front grille with condenser cleaning brush kit**

Front grille cover is easily removable without any tools, which makes condenser cleaning easy and convenient at any time. Handy condenser cleaning brush is included inside the front grille cover.

■ **Refrigerator holds 33°F ~ 39°F for the best in food preservation**

■ **Standard features**

- Anti-corrosion coated evaporator
- Self-contained system
- 4" dia. swivel casters with locks on the front set
- Door locks



LED interior lighting & fan control

Energy efficient LED lighting lights every corner, making items easy to find. Fan control function automatically shuts off the fan when the door is open, which prevents hot air from being drawn in, thus maintaining the cool inner temperature.

■ **Optional features**

- Casters available for all models: 1", 2.5", 5"
- Legs available for all models: 6"

JUR-G MODELS SPECIFICATIONS

ELECTRICAL DATA	JUR-48-G-N	JUR-60-G-N	JUR-72-G-N
Voltage	115/60/1	115/60/1	115/60/1
Plug Type	Ⓢ NEMA 5-15P	Ⓢ NEMA 5-15P	Ⓢ NEMA 5-15P
Full Load Amp.	2.3	2.3	2.3
Compressor HP	1/4	1/4	1/4
Cord Length (ft.)	9	9	9
Refrigerant	R-290	R-290	R-290
DIMENSIONAL DATA			
Net Capacity (cu. ft.)	10.66	14.58	18.74
Ext. Dimension (L x D ^o x H [†]) (in.)	47 ^{1/4} x 27 ^{1/2} x 28 ^{3/4}	59 x 27 ^{1/2} x 28 ^{3/4}	70 ^{7/8} x 27 ^{1/2} x 28 ^{3/4}
# of Doors	2	2	3
# of Shelves	2	2	3
Shelf Size (L x D) (in.)	15 ^{1/2} x 20 ^{1/4}	21 ^{3/8} x 20 ^{1/4}	17 ^{1/2} x 20 ^{1/4} (L/R), 19 ^{1/2} x 20 ^{1/4} (M)
Net Weight (lbs.)	212	242	279
Gross Weight (lbs.)	272	312	370

Design and specifications subject to change without notice. Most updated spec sheets are available at www.turboairinc.com.

Actual shipping weight may differ due to extra packing materials for product protection.

* Depth does not include 2-1/4" for door handles & rear spacers. † Height does not include 4-3/4" for caster height.

■ **WARRANTY: 2 Year Parts and Labor Warranty, 5 Year Compressor Warranty**

UNDERCOUNTER FREEZERS **NATURAL Refrigerant**

■ **Digital temperature control & monitor system**

Keeps food products safe by maintaining constant temperatures. External digital display allows for easy monitoring.

■ **Hydrocarbon refrigerants (R-290)**

With innovative and eco-friendly technology, Turbo Air brings you hydrocarbon refrigerators designed to meet DOE's Energy Conservation Standards in 2017 and to use EPA's SNAP Program approved HC refrigerants. Hydrocarbon refrigerants do not deplete the ozone layer and have very low contribution to global warming (ODP-0, GWP-3).

■ **Side mount compressor unit**

With compressors positioned on the side of the unit, our refrigerators can now be serviced without being moved. Our front air intake feature also allows this model to be highly efficient in narrow spaces.

■ **Stainless steel exterior**

The Turbo Air J series boasts a stainless steel exterior (galvanized steel back and bottom). Interior is stainless steel floor with AL sides, back and AL door liners. It guarantees the utmost in cleanliness and long product life. The J series adds a touch of style to the most refined setting.

■ **High-density polyurethane insulation**

The entire cabinet structure and solid doors are foamed-in-place using high density, CFC free polyurethane insulation.

■ **Ergonomically designed doors**

Customers' fatigue fades away with easy grip handles and doors that open effortlessly. These features along with self-closing doors make this the ultimate choice in customer convenience.

■ **Adjustable, heavy duty, PE (polyethylene) coated wire shelves**

■ **Easy open front grille with condenser cleaning brush kit**

Front grille cover is easily removable without any tools, which makes condenser cleaning easy and convenient at any time. Handy condenser cleaning brush is included inside the front grille cover.

■ **Freezer holds -10°F ~ 0°F for the best in frozen food preservation**

■ **Standard features**

- Anti-corrosion coated evaporator
- Self-contained system
- 4" dia. swivel casters with locks on the front set

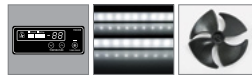

LED interior lighting & fan control

Energy efficient LED lighting lights every corner, making items easy to find. Fan control function automatically shuts off the fan when the door is open, which prevents hot air from being drawn in, thus maintaining the cool inner temperature.

■ **Optional features**

- Casters available for all models: 1", 2.5", 5"
- Door locks available (extra lead time will apply)
- Legs available for all models: 6"

JUF MODELS SPECIFICATIONS

ELECTRICAL DATA	JUF-36-N	JUF-48-N	JUF-60-N
Voltage	115/60/1	115/60/1	115/60/1
Plug Type	Ⓜ NEMA 5-15P	Ⓜ NEMA 5-15P	Ⓜ NEMA 5-15P
Full Load Amp.	2.6	2.6	4.8
Compressor HP	1/3	1/3	1/2
Cord Length (ft.)	9	9	9
Refrigerant	R-290	R-290	R-290
DIMENSIONAL DATA			
Net Capacity (cu. ft.)	6.37	9.93	13.58
Ext. Dimension (L x D [†] x H [†]) (in.)	35 ³ / ₈ x 27 ¹ / ₂ x 28 ³ / ₄	47 ¹ / ₄ x 27 ¹ / ₂ x 28 ³ / ₄	59 x 27 ¹ / ₂ x 28 ³ / ₄
# of Doors	1	2	2
# of Shelves	1	2	2
Shelf Size (L x D) (in.)	19 ¹ / ₂ x 20 ¹ / ₄	15 ¹ / ₂ x 20 ¹ / ₄	21 ³ / ₈ x 20 ¹ / ₄
Net Weight (lbs.)	157	184	205
Gross Weight (lbs.)	197	232	257

Design and specifications subject to change without notice. Most updated spec sheets are available at www.turboairinc.com.

Actual shipping weight may differ due to extra packing materials for product protection.

* Depth does not include 1-1/4" for rear spacers. † Height does not include 4-3/4" for caster height.

■ **WARRANTY: 2 Year Parts and Labor Warranty, 5 Year Compressor Warranty**

UNDERCOUNTER REFRIGERATORS - NARROW NATURAL Refrigerant

■ **Digital temperature control & monitor system**

Keeps food products safe by maintaining constant temperatures. External digital display allows for easy monitoring.

■ **Hydrocarbon refrigerants (R-600a)**

With innovative and eco-friendly technology, Turbo Air brings you hydrocarbon refrigerators designed to meet DOE's Energy Conservation Standards in 2017 and to use EPA's SNAP Program approved HC refrigerants. Hydrocarbon refrigerants do not deplete the ozone layer and have very low contribution to global warming (ODP-0, GWP-3).

■ **Side mount compressor unit**

With compressors positioned on the side of the unit, our refrigerators can now be serviced without being moved. Our front air intake feature also allows this model to be highly efficient in narrow spaces.

■ **Stainless steel exterior**

The Turbo Air J series boasts a stainless steel exterior (galvanized steel back and bottom). Interior is stainless steel floor with AL sides, back and AL door liners. It guarantees the utmost in cleanliness and long product life. The J series adds a touch of style to the most refined setting.

■ **High-density polyurethane insulation**

The entire cabinet structure and solid doors are foamed-in-place using high density, CFC free polyurethane insulation.

■ **Ergonomically designed doors**

Customers' fatigue fades away with easy grip handles and doors that open effortlessly. These features along with self-closing doors make this the ultimate choice in customer convenience.

■ **Adjustable, heavy duty, PE (polyethylene) coated wire shelves**

■ **Easy open front grille with condenser cleaning brush kit**

Front grille cover is easily removable without any tools, which makes condenser cleaning easy and convenient at any time. Handy condenser cleaning brush is included inside the front grille cover.

■ **Refrigerator holds 33°F ~ 39°F for the best in food preservation**

■ **Standard features**

- Anti-corrosion coated evaporator
- Self-contained system
- 4" dia. swivel casters with locks on the front set



JUR-72S-N6



JUR-48S-N6



JUR-36S-N6

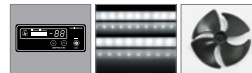

LED interior lighting & fan control

Energy efficient LED lighting lights every corner, making items easy to find. Fan control function automatically shuts off the fan when the door is open, which prevents hot air from being drawn in, thus maintaining the cool inner temperature.

■ **Optional features**

- Casters available for all models: 1", 2.5", 5"
- Door locks available (extra lead time will apply)
- Legs available for all models: 6"

JUR-S MODELS SPECIFICATIONS

ELECTRICAL DATA	JUR-36S-N6	JUR-48S-N6	JUR-60S-N6	JUR-72S-N6
Voltage	115/60/1	115/60/1	115/60/1	115/60/1
Plug Type	Ⓢ NEMA 5-15P	Ⓢ NEMA 5-15P	Ⓢ NEMA 5-15P	Ⓢ NEMA 5-15P
Full Load Amp.	1.7	1.7	1.9	1.9
Compressor HP	1/6	1/6	1/5	1/5
Cord Length (ft.)	9	9	9	9
Refrigerant	R-600a	R-600a	R-600a	R-600a
DIMENSIONAL DATA				
Net Capacity (cu. ft.)	5.66	8.27	11.31	15.17
Ext. Dimension (L x D [†] x H [†]) (in.)	35 ³ / ₈ x 23 ⁵ / ₈ x 28 ³ / ₄	47 ¹ / ₄ x 23 ⁵ / ₈ x 28 ³ / ₄	59 x 23 ⁵ / ₈ x 28 ³ / ₄	70 ⁷ / ₈ x 23 ⁵ / ₈ x 28 ³ / ₄
# of Doors	1	2	2	3
# of Shelves	1	2	2	3
Shelf Size (L x D) (in.)	19 ¹ / ₂ x 16 ¹ / ₄	15 ¹ / ₂ x 16 ¹ / ₄	21 ³ / ₈ x 16 ¹ / ₄	17 ¹ / ₄ x 16 ¹ / ₄ (L/R), 19 ¹ / ₂ x 16 ¹ / ₄ (M)
Net Weight (lbs.)	145	160	180	205
Gross Weight (lbs.)	181	190	210	240

Design and specifications subject to change without notice. Most updated spec sheets are available at www.turboairinc.com.

Actual shipping weight may differ due to extra packing materials for product protection.

* Depth does not include 1-1/4" for rear spacers. † Height does not include 4-3/4" for caster height.

■ **WARRANTY: 2 Year Parts and Labor Warranty, 5 Year Compressor Warranty**

UNDERCOUNTER FREEZERS - NARROW NATURAL Refrigerant

■ **Digital temperature control & monitor system**

Keeps food products safe by maintaining constant temperatures. External digital display allows for easy monitoring.

■ **Hydrocarbon refrigerants (R-290)**

With innovative and eco-friendly technology, Turbo Air brings you hydrocarbon refrigerators designed to meet DOE's Energy Conservation Standards in 2017 and to use EPA's SNAP Program approved HC refrigerants. Hydrocarbon refrigerants do not deplete the ozone layer and have very low contribution to global warming (ODP-0, GWP-3).

■ **Side mount compressor unit**

With compressors positioned on the side of the unit, our refrigerators can now be serviced without being moved. Our front air intake feature also allows this model to be highly efficient in narrow spaces.

■ **Stainless steel exterior**

The Turbo Air J series boasts a stainless steel exterior (galvanized steel back and bottom). Interior is stainless steel floor with AL sides, back and AL door liners. It guarantees the utmost in cleanliness and long product life. The J series adds a touch of style to the most refined setting.

■ **High-density polyurethane insulation**

The entire cabinet structure and solid doors are foamed-in-place using high density, CFC free polyurethane insulation.

■ **Ergonomically designed doors**

Customers' fatigue fades away with easy grip handles and doors that open effortlessly. These features along with self-closing doors make this the ultimate choice in customer convenience.

■ **Adjustable, heavy duty, PE (polyethylene) coated wire shelves**

■ **Easy open front grille with condenser cleaning brush kit**

Front grille cover is easily removable without any tools, which makes condenser cleaning easy and convenient at any time. Handy condenser cleaning brush is included inside the front grille cover.

■ **Freezer holds -10°F ~ 0°F for the best in frozen food preservation**

■ **Standard features**

- Anti-corrosion coated evaporator
- Self-contained system
- 4" dia. swivel casters with locks on the front set

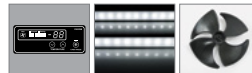

LED interior lighting & fan control

Energy efficient LED lighting lights every corner, making items easy to find. Fan control function automatically shuts off the fan when the door is open, which prevents hot air from being drawn in, thus maintaining the cool inner temperature.

■ **Optional features**

- Casters available for all models: 1", 2.5", 5"
- Door locks available (extra lead time will apply)
- Legs available for all models: 6"

JUF-S MODELS SPECIFICATIONS

ELECTRICAL DATA	JUF-36S-N	JUF-48S-N	JUF-60S-N
Voltage	115/60/1	115/60/1	115/60/1
Plug Type	Ⓢ NEMA 5-15P	Ⓢ NEMA 5-15P	Ⓢ NEMA 5-15P
Full Load Amp.	2.8	2.6	4.0
Compressor HP	1/3	3/8+	3/8+
Cord Length (ft.)	9	9	9
Refrigerant	R-290	R-290	R-290
DIMENSIONAL DATA			
Net Capacity (cu. ft.)	5.66	8.92	11.31
Ext. Dimension (L x D x H†) (in.)	35 ³ / ₈ x 23 ⁵ / ₈ x 28 ³ / ₄	47 ¹ / ₄ x 23 ⁵ / ₈ x 28 ³ / ₄	59 x 23 ⁵ / ₈ x 28 ³ / ₄
# of Doors	1	2	2
# of Shelves	1	2	2
Shelf Size (L x D) (in.)	19 ¹ / ₂ x 16 ¹ / ₄	15 ¹ / ₂ x 16 ¹ / ₄	21 ³ / ₈ x 16 ¹ / ₄
Net Weight (lbs.)	145	160	180
Gross Weight (lbs.)	181	190	210

Design and specifications subject to change without notice. Most updated spec sheets are available at www.turboairinc.com.

Actual shipping weight may differ due to extra packing materials for product protection.

* Depth does not include 1-1/4" for rear spacers. † Height does not include 4-3/4" for caster height.

■ **WARRANTY: 2 Year Parts and Labor Warranty, 5 Year Compressor Warranty**

UNDERCOUNTER REFRIGERATORS - EXTRA DEEP NATURAL Refrigerant

■ **Digital temperature control & monitor system**

Keeps food products safe by maintaining constant temperatures. External digital display allows for easy monitoring.

■ **Hydrocarbon refrigerants (R-290)**

With innovative and eco-friendly technology, Turbo Air brings you hydrocarbon refrigerators designed to meet DOE's Energy Conservation Standards in 2017 and to use EPA's SNAP Program approved HC refrigerants. Hydrocarbon refrigerants do not deplete the ozone layer and have very low contribution to global warming (ODP-0, GWP-3).

■ **Side mount compressor unit**

With compressors positioned on the side of the unit, our refrigerators can now be serviced without being moved. Our front air intake feature also allows this model to be highly efficient in narrow spaces.

■ **Stainless steel exterior**

The Turbo Air J series boasts a stainless steel exterior (galvanized steel back and bottom). Interior is stainless steel floor with AL sides, back and AL door liners. It guarantees the utmost in cleanliness and long product life. The J series adds a touch of style to the most refined setting.

■ **High-density polyurethane insulation**

The entire cabinet structure and solid doors are foamed-in-place using high density, CFC free polyurethane insulation.

■ **Ergonomically designed doors**

Customers' fatigue fades away with easy grip handles and doors that open effortlessly. These features along with self-closing doors make this the ultimate choice in customer convenience.

■ **Adjustable, heavy duty, PE (polyethylene) coated wire shelves**

■ **Refrigerator holds 33°F ~ 39°F for the best in food preservation**

■ **Standard features**

- Anti-corrosion coated evaporator
- Self-contained system
- 4" dia. swivel casters with locks on the front set

■ **Optional features**

- Casters available for all models: 2.5", 5"
- Door locks available (extra lead time will apply)
- Legs available for all models: 6"



JUR-44D-N



JUR-67D-N



LED interior lighting & fan control

Energy efficient LED lighting lights every corner, making items easy to find. Fan control function automatically shuts off the fan when the door is open, which prevents hot air from being drawn in, thus maintaining the cool inner temperature.

JUR MODELS SPECIFICATIONS

ELECTRICAL DATA	JUR-44D-N	JUR-67D-N	JUR-93D-N
Voltage	115/60/1	115/60/1	115/60/1
Plug Type	Ⓢ NEMA 5-15P	Ⓢ NEMA 5-15P	Ⓢ NEMA 5-15P
Full Load Amp.	2.1	2.2	5.1
Compressor HP	2/5	1/2	1/2+
Cord Length (ft.)	9	9	9
Refrigerant	R-290	R-290	R-290
DIMENSIONAL DATA			
Net Capacity (cu. ft.)	11	19	30
Ext. Dimension (L x D* x H†) (in.)	44 x 32 ¹ / ₄ x 31 ¹ / ₄	67 x 32 ¹ / ₄ x 31 ¹ / ₄	93 x 32 ¹ / ₄ x 31 ¹ / ₄
# of Doors	1	2	3
# of Shelves	2	4	6
Shelf Size (L x D) (in.)	24 ⁷ / ₈ x 25 ¹ / ₂	23 ⁷ / ₈ x 25 ¹ / ₂	23 ⁷ / ₈ x 25 ¹ / ₂ , 25 ⁷ / ₈ x 25 ¹ / ₂
Net Weight (lbs.)	210	346	511
Gross Weight (lbs.)	290	400	550

Design and specifications subject to change without notice. Most updated spec sheets are available at www.turboairinc.com.

Actual shipping weight may differ due to extra packing materials for product protection.

* Depth does not include 1" for rear spacers. † Height does not include 5" for caster height.

■ **WARRANTY: 2 Year Parts and Labor Warranty, 5 Year Compressor Warranty**

UNDERCOUNTER FREEZERS - EXTRA DEEP NATURAL Refrigerant

■ **Digital temperature control & monitor system**

Keeps food products safe by maintaining constant temperatures. External digital display allows for easy monitoring.

■ **Hydrocarbon refrigerants (R-290)**

With innovative and eco-friendly technology, Turbo Air brings you hydrocarbon refrigerators designed to meet DOE's Energy Conservation Standards in 2017 and to use EPA's SNAP Program approved HC refrigerants. Hydrocarbon refrigerants do not deplete the ozone layer and have very low contribution to global warming (ODP-0, GWP-3).

■ **Side mount compressor unit**

With compressors positioned on the side of the unit, our refrigerators can now be serviced without being moved. Our front air intake feature also allows this model to be highly efficient in narrow spaces.

■ **Stainless steel exterior**

The Turbo Air J series boasts a stainless steel exterior (galvanized steel back and bottom). Interior is stainless steel floor with AL sides, back and AL door liners. It guarantees the utmost in cleanliness and long product life. The J series adds a touch of style to the most refined setting.

■ **High-density polyurethane insulation**

The entire cabinet structure and solid doors are foamed-in-place using high density, CFC free polyurethane insulation.

■ **Ergonomically designed doors**

Customers' fatigue fades away with easy grip handles and doors that open effortlessly. These features along with self-closing doors make this the ultimate choice in customer convenience.

■ **Adjustable, heavy duty, PE (polyethylene) coated wire shelves**

■ **Freezer holds -10°F ~ 0°F for the best in frozen food preservation**

■ **Standard features**

- Anti-corrosion coated evaporator
- Self-contained system
- 4" dia. swivel casters with locks on the front set

■ **Optional features**

- Casters available for all models: 2.5", 5"
- Door locks available (extra lead time will apply)
- Legs available for all models: 6"



LED interior lighting & fan control

Energy efficient LED lighting lights every corner, making items easy to find. Fan control function automatically shuts off the fan when the door is open, which prevents hot air from being drawn in, thus maintaining the cool inner temperature.

JUF MODELS SPECIFICATIONS

ELECTRICAL DATA	JUF-44D-N	JUF-67D-N	JUF-93D-N
Voltage	115/60/1	115/60/1	115/60/1
Plug Type	Ⓢ NEMA 5-15P	Ⓢ NEMA 5-15P	Ⓢ NEMA 5-15P
Full Load Amp.	2.6	4.5	4.8
Compressor HP	1/2	1/2	1/2+
Cord Length (ft.)	9	9	9
Refrigerant	R-290	R-290	R-290
DIMENSIONAL DATA			
Net Capacity (cu. ft.)	11	19	30
Ext. Dimension (L x D [*] x H [†]) (in.)	44 x 32 ¹ / ₄ x 31 ¹ / ₄	67 x 32 ¹ / ₄ x 31 ¹ / ₄	93 x 32 ¹ / ₄ x 31 ¹ / ₄
# of Doors	1	2	3
# of Shelves	2	4	6
Shelf Size (L x D) (in.)	24 ⁷ / ₈ x 25 ¹ / ₂	23 ⁷ / ₈ x 25 ¹ / ₂	23 ⁷ / ₈ x 25 ¹ / ₂ , 25 ⁷ / ₈ x 25 ¹ / ₂
Net Weight (lbs.)	213	346	511
Gross Weight (lbs.)	293	405	555

Design and specifications subject to change without notice. Most updated spec sheets are available at www.turboairinc.com.

Actual shipping weight may differ due to extra packing materials for product protection.

* Depth does not include 1" for rear spacers. † Height does not include 5" for caster height.

■ **WARRANTY: 2 Year Parts and Labor Warranty, 5 Year Compressor Warranty**

DUAL TEMP. UNDERCOUNTERS NATURAL Refrigerant

■ **Digital temperature control & monitor system**

Keeps food products safe by maintaining constant temperatures. External digital display allows for easy monitoring.

■ **Hydrocarbon refrigerants (R-290)**

With innovative and eco-friendly technology, Turbo Air brings you hydrocarbon refrigerators designed to meet DOE's Energy Conservation Standards in 2017 and to use EPA's SNAP Program approved HC refrigerants. Hydrocarbon refrigerants do not deplete the ozone layer and have very low contribution to global warming (ODP-0, GWP-3).

■ **Side mount compressor unit**

With compressors positioned on the side of the unit, our refrigerators can now be serviced without being moved. Our front air intake feature also allows this model to be highly efficient in narrow spaces.

■ **Stainless steel exterior**

The Turbo Air J series boasts a stainless steel exterior (galvanized steel back and bottom). Interior is stainless steel floor with AL sides, back and AL door liners. It guarantees the utmost in cleanliness and long product life. The J series adds a touch of style to the most refined setting.

■ **Hot gas condensate system**

Through Turbo Air's creative innovation, the condensate system surfaces have been specially treated to resist corrosion. This not only increases efficiency without the risk of refrigerant leakage from corrosion, but also thoroughly prevents the overflow of condensate water.

■ **Ergonomically designed doors**

Customers' fatigue fades away with easy grip handles and doors that open effortlessly. These features along with self-closing doors make this the ultimate choice in customer convenience.

■ **Adjustable, heavy duty, PE (polyethylene) coated wire shelves**

■ **Easy open front grille with condenser cleaning brush kit**

Front grille cover is easily removable without any tools, which makes condenser cleaning easy and convenient at any time. Handy condenser cleaning brush is included inside the front grille cover.

■ **Refrigerator holds 33°F ~ 39°F and freezer holds -10°F ~ 0°F for the best in food preservation**

■ **Standard features**

- Anti-corrosion coated evaporator
- Self-contained system
- 4" dia. swivel casters with locks on the front set
- High-density polyurethane insulation

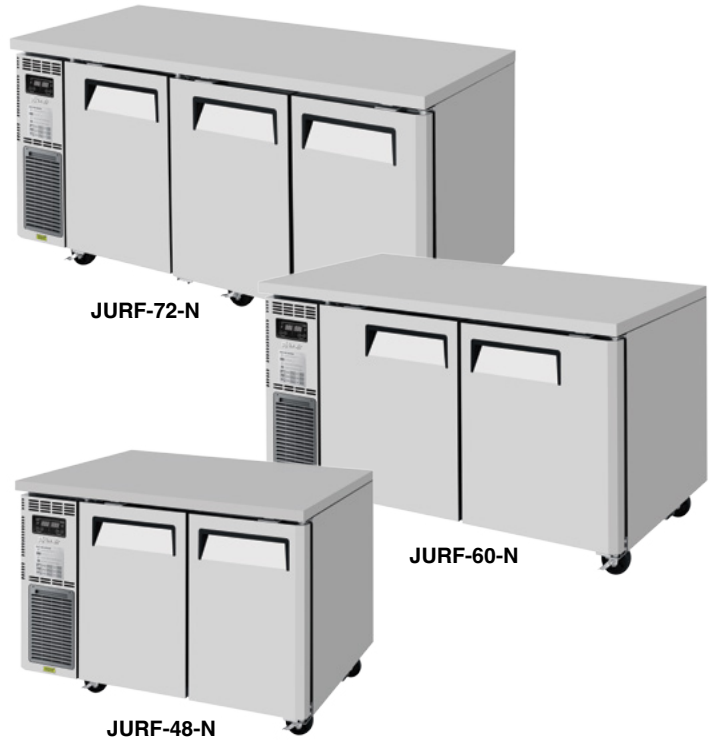

■ **LED interior lighting & fan control**

Energy efficient LED lighting lights every corner, making items easy to find. Fan control function automatically shuts off the fan when the door is open, which prevents hot air from being drawn in, thus maintaining the cool inner temperature.

■ **Optional features**

- Casters available for all models: 1", 2.5", 5"
- Door locks available (extra lead time will apply)
- Legs available for all models: 6"

JURF MODELS SPECIFICATIONS

ELECTRICAL DATA		JURF-48-N	JURF-60-N	JURF-72-N
Voltage		115/60/1	115/60/1	115/60/1
Plug Type		Ⓜ NEMA 5-15P	Ⓜ NEMA 5-15P	Ⓜ NEMA 5-15P
Full Load Amp.		2.5	2.6	3.5
Compressor HP		1/3	1/3	2/5
Cord Length (ft.)		9	9	9
Refrigerant		R-290	R-290	R-290
DIMENSIONAL DATA				
Net Capacity (cu. ft.)	Refrigerator	4.48	6.28	12.18
	Freezer	4.96	6.89	5.58
Ext. Dimension (L x D x HT) (in.)		47 ¹ / ₄ x 27 ¹ / ₂ x 28 ³ / ₄	59 x 27 ¹ / ₂ x 28 ³ / ₄	70 ⁷ / ₈ x 27 ¹ / ₂ x 28 ³ / ₄
# of Doors		2	2	3
# of Shelves		2	2	3
Shelf Size (L x D) (in.)		13 ⁵ / ₈ x 20 ¹ / ₄ (L), 13 ⁵ / ₈ x 17 ³ / ₄ (R)	19 ⁵ / ₈ x 20 ¹ / ₄ (L), 19 ⁵ / ₈ x 17 ³ / ₄ (R)	15 ¹ / ₂ x 20 ¹ / ₄ (L), 17 ⁵ / ₈ x 17 ³ / ₄ (M/R)
Net Weight (lbs.)		200	220	275
Gross Weight (lbs.)		230	260	295

Design and specifications subject to change without notice. Most updated spec sheets are available at www.turboairinc.com.

Actual shipping weight may differ due to extra packing materials for product protection.

* Depth does not include 1-1/4" for rear spacers. † Height does not include 4-3/4" for caster height.

■ **WARRANTY: 2 Year Parts and Labor Warranty, 5 Year Compressor Warranty**

WORKTOP REFRIGERATORS NATURAL Refrigerant

Self-Cleaning Condenser Equipped Units

■ **Self-Cleaning Condenser (Patented)**

The accumulation of dust in the condenser can cause the failure or breakdown of refrigerators. Refrigerators run normally until they reach a certain level of accumulation. At some point, when they are over the limit, their performance drops quickly resulting in damage to, or disposal of the stored products inside. The Self-Cleaning Condenser device keeps the condenser clean and prevents system failure by automatically brushing daily.

■ **Digital temperature control & monitor system**

Keeps food products safe by maintaining constant temperatures. External digital display allows for easy monitoring.

■ **Hydrocarbon refrigerants (R-290)**

With innovative and eco-friendly technology, Turbo Air brings you hydrocarbon refrigerators designed to meet DOE's Energy Conservation Standards in 2017 and to use EPA's SNAP Program approved HC refrigerants. Hydrocarbon refrigerants do not deplete the ozone layer and have very low contribution to global warming (ODP-0, GWP-3).

■ **Stainless steel cabinet construction**

The PRO series model boasts a stainless steel interior and a 22 gauge stainless steel exterior (galvanized steel bottom). It guarantees the utmost in cleanliness and long product life. The PRO series adds a touch of style to the most refined setting.

■ **Sturdy, clean stainless steel shelving**

Shelves are the most important part of cleanliness as they come in direct contact with food. The PRO series uniquely provides stainless steel shelving.

■ **Ergonomically designed doors**

Customers' fatigue fades away with easy grip handles and doors that open effortlessly. These features along with self-closing doors make this the ultimate choice in customer convenience.

■ **High-density polyurethane insulation**

The entire cabinet structure and solid doors are foamed-in-place using high density, CFC free polyurethane insulation.

■ **Left hinged model available (PWR-28-N-L)**

■ **Spring assisted heavy duty gravity hinge**

■ **Refrigerator holds 33°F ~ 38°F for the best in food preservation**

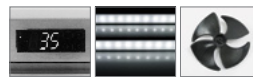

LED interior lighting & fan control

Energy efficient LED lighting lights every corner, making items easy to find. Fan control function automatically shuts off the fan when the door is open, which prevents hot air from being drawn in, thus maintaining the cool inner temperature.

■ **Standard features**

- Anti-corrosion coated evaporator
- Self-contained system
- 4" dia. swivel casters with locks on the front set
- Door locks
- Lead time applies

■ **Optional features**

- Legs available for all models: 6"
- Stainless steel single overshef available (except PWR-28-N)
- Casters available for all models: 1" (1.5" low profile caster kit for PWR-28-N), 2.5" (except PWR-28-N), 5"

PWR MODELS SPECIFICATIONS

ELECTRICAL DATA	PWR-28-N	PWR-48-N	PWR-60-N	PWR-72-N
Voltage	115/60/1	115/60/1	115/60/1	115/60/1
Plug Type	Ⓜ NEMA 5-15P	Ⓜ NEMA 5-15P	Ⓜ NEMA 5-15P	Ⓜ NEMA 5-15P
Full Load Amp.	6.6	6.5	8.9	9.9
Compressor HP	1/6	1/6	1/6	1/6
Cord Length (ft.)	10	10	10	10
Refrigerant	R-290	R-290	R-290	R-290
DIMENSIONAL DATA				
Net Capacity (cu. ft.)	6.8	12.2	15.5	18.8
Ext. Dimension (L x D [†] x H [†]) (in.)	27 1/2 x 30 x 34 1/8	48 1/4 x 30 x 34 1/8	60 1/4 x 30 x 34 1/8	72 5/8 x 30 x 34 1/8
# of Doors	1	2	2	2
# of Shelves	1	2	2	2
Shelf Size (L x D) (in.)	22 1/2 x 17	21 x 17	27 x 17	33 1/8 x 17
Net Weight (lbs.)	155	238	258	320
Gross Weight (lbs.)	167	285	349	355

Design and specifications subject to change without notice. Most updated spec sheets are available at www.turboairinc.com.

Actual shipping weight may differ due to extra packing materials for product protection.

* Depth does not include 2" for door handles and rear spacers. † Height does not include 4-1/2" for caster height.

■ **WARRANTY: 5 Year Parts and Labor Warranty, 7 Year Compressor Warranty**

GLASS DOOR WORKTOP REFRIGERATORS NATURAL Refrigerant

Self-Cleaning Condenser Equipped Units

■ **Self-Cleaning Condenser (Patented)**

The accumulation of dust in the condenser can cause the failure or breakdown of refrigerators. Refrigerators run normally until they reach a certain level of accumulation. At some point, when they are over the limit, their performance drops quickly resulting in damage to, or disposal of the stored products inside. The Self-Cleaning Condenser device keeps the condenser clean and prevents system failure by automatically brushing daily.

■ **Digital temperature control & monitor system**

Keeps food products safe by maintaining constant temperatures. External digital display allows for easy monitoring.

■ **Hydrocarbon refrigerants (R-290)**

With innovative and eco-friendly technology, Turbo Air brings you hydrocarbon refrigerators designed to meet DOE's Energy Conservation Standards in 2017 and to use EPA's SNAP Program approved HC refrigerants. Hydrocarbon refrigerants do not deplete the ozone layer and have very low contribution to global warming (ODP-0, GWP-3).

■ **Stainless steel cabinet construction**

The PRO series model boasts a stainless steel interior and a 22 gauge stainless steel exterior (galvanized steel bottom). It guarantees the utmost in cleanliness and long product life. The PRO series adds a touch of style to the most refined setting.

■ **Sturdy, clean stainless steel shelving**

Shelves are the most important part of cleanliness as they come in direct contact with food. The PRO series uniquely provides stainless steel shelving.

■ **Ergonomically designed doors**

Customers' fatigue fades away with easy grip handles and doors that open effortlessly. These features along with self-closing doors make this the ultimate choice in customer convenience.

■ **High-density polyurethane insulation**

The entire cabinet structure and solid doors are foamed-in-place using high density, CFC free polyurethane insulation.

■ **Left hinged model available (PWR-28-G-N-L)**

■ **Spring assisted heavy duty gravity hinge**

■ **Refrigerator holds 33°F ~ 38°F for the best in food preservation**

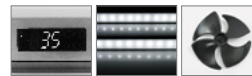

LED interior lighting & fan control

Energy efficient LED lighting lights every corner, making items easy to find. Fan control function automatically shuts off the fan when the door is open, which prevents hot air from being drawn in, thus maintaining the cool inner temperature.

■ **Standard features**

- Anti-corrosion coated evaporator
- Self-contained system
- 4" dia. swivel casters with locks on the front set
- Door locks
- Lead time applies

■ **Optional features**

- Legs available for all models: 6"
- Stainless steel single overshef available (except PWR-28-G-N)
- Casters available for all models: 1" (1.5" low profile caster kit for PWR-28-G-N), 2.5" (except PWR-28-G-N), 5"

PWR-G MODELS SPECIFICATIONS

ELECTRICAL DATA	PWR-28-G-N	PWR-48-G-N	PWR-60-G-N	PWR-72-G-N
Voltage	115/60/1	115/60/1	115/60/1	115/60/1
Plug Type	Ⓜ NEMA 5-15P	Ⓜ NEMA 5-15P	Ⓜ NEMA 5-15P	Ⓜ NEMA 5-15P
Full Load Amp.	6.6	6.5	8.9	9.9
Compressor HP	1/6	1/6	1/6	1/6
Cord Length (ft.)	10	10	10	10
Refrigerant	R-290	R-290	R-290	R-290
DIMENSIONAL DATA				
Net Capacity (cu. ft.)	6.8	12.2	17.2	18.8
Ext. Dimension (L x D [†] x H [†]) (in.)	27 ¹ / ₂ x 30 x 34 ¹ / ₈	48 ¹ / ₄ x 30 x 34 ¹ / ₈	60 ¹ / ₄ x 30 ³ / ₄ x 38 ⁷ / ₈	72 ⁵ / ₈ x 30 x 34 ¹ / ₈
# of Doors	1	2	2	2
# of Shelves	1	2	2	2
Shelf Size (L x D) (in.)	22 ¹ / ₂ x 17	21 x 17	27 x 17	33 ¹ / ₈ x 17
Net Weight (lbs.)	165	248	258	330
Gross Weight (lbs.)	177	295	349	365

Design and specifications subject to change without notice. Most updated spec sheets are available at www.turboairinc.com.

Actual shipping weight may differ due to extra packing materials for product protection.

* Depth does not include 2" and 1-3/8"(PWR-60-G-N) for door handles and rear spacers. † Height does not include 4-1/2" and 4-3/4"(PWR-60-G-N) for caster height.

■ **WARRANTY: 5 Year Parts and Labor Warranty, 7 Year Compressor Warranty**

WORKTOP REFRIGERATORS - DRAWERS NATURAL Refrigerant

Self-Cleaning Condenser Equipped Units

■ **Self-Cleaning Condenser (Patented)**

The accumulation of dust in the condenser can cause the failure or breakdown of refrigerators. Refrigerators run normally until they reach a certain level of accumulation. At some point, when they are over the limit, their performance drops quickly resulting in damage to, or disposal of the stored products inside. The Self-Cleaning Condenser device keeps the condenser clean and prevents system failure by automatically brushing daily.

■ **Digital temperature control & monitor system**

Keeps food products safe by maintaining constant temperatures. External digital display allows for easy monitoring.

■ **Hydrocarbon refrigerants (R-290)**

With innovative and eco-friendly technology, Turbo Air brings you hydrocarbon refrigerators designed to meet DOE's Energy Conservation Standards in 2017 and to use EPA's SNAP Program approved HC refrigerants. Hydrocarbon refrigerants do not deplete the ozone layer and have very low contribution to global warming (ODP-0, GWP-3).

■ **Stainless steel cabinet construction**

The PRO series model boasts a stainless steel interior and a **22 gauge** stainless steel exterior (galvanized steel bottom). It guarantees the utmost in cleanliness and long product life. The PRO series adds a touch of style to the most refined setting.

■ **Sturdy, clean stainless steel shelving**

Shelves are the most important part of cleanliness as they come in direct contact with food. The PRO series uniquely provides stainless steel shelving (only PWR-48-D2R(L)-N).

■ **Ergonomically designed doors**

Customers' fatigue fades away with easy grip handles and doors that open effortlessly. These features along with self-closing doors make this the ultimate choice in customer convenience (only PWR-48-D2R(L)-N).

■ **High-density polyurethane insulation**

The entire cabinet structure and solid doors are foamed-in-place using high density, CFC free polyurethane insulation.

■ **Spring assisted heavy duty gravity hinge**

(only PWR-48-D2R(L)-N)

■ **Refrigerator holds 33°F ~ 38°F for the best in food preservation**

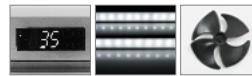

LED interior lighting & fan control

Energy efficient LED lighting lights every corner, making items easy to find. Fan control function automatically shuts off the fan when the door is open, which prevents hot air from being drawn in, thus maintaining the cool inner temperature (only PWR-48-D2R(L)-N).

■ **Standard features**

- Anti-corrosion coated evaporator
- Self-contained system
- 4" dia. swivel casters with locks on the front set
- Door locks (only PWR-48-D2R(L)-N)
- Lead time applies

■ **Optional features**

- Legs available for all models: 6"
- Stainless steel single overshef available (except PWR-28-D2-N)
- Casters available for all models: 1" (1.5" low profile caster kit for PWR-28-D2-N), 2.5" (except PWR-28-D2-N), 5"

PWR MODELS SPECIFICATIONS

ELECTRICAL DATA	PWR-28-D2-N	PWR-48-D2R(L)-N	PWR-48-D4-N
Voltage	115/60/1	115/60/1	115/60/1
Plug Type	Ⓢ NEMA 5-15P	Ⓢ NEMA 5-15P	Ⓢ NEMA 5-15P
Full Load Amp.	6.6	6.5	6.5
Compressor HP	1/6	1/6	1/6
Cord Length (ft.)	10	10	10
Refrigerant	R-290	R-290	R-290
DIMENSIONAL DATA			
Net Capacity (cu. ft.)	6.8	12.2	12.2
Ext. Dimension (L x D* x H†) (in.)	27 1/2 x 30 x 34 1/8	48 1/4 x 30 x 34 1/8	48 1/4 x 30 x 34 1/8
# of Doors	-	1	-
# of Drawers	2	2	4
# of Shelves	-	1	-
Shelf Size (L x D) (in.)	-	21 x 17	-
Net Weight (lbs.)	228	238	245
Gross Weight (lbs.)	234	249	254

Design and specifications subject to change without notice. Most updated spec sheets are available at www.turboairinc.com.

Actual shipping weight may differ due to extra packing materials for product protection.

* Depth does not include 2" for door handles and rear spacers. † Height does not include 4-1/2" for caster height.

■ **WARRANTY: 5 Year Parts and Labor Warranty, 7 Year Compressor Warranty**

WORKTOP REFRIGERATORS - DRAWERS NATURAL Refrigerant

Self-Cleaning Condenser Equipped Units

■ **Self-Cleaning Condenser (Patented)**

The accumulation of dust in the condenser can cause the failure or breakdown of refrigerators. Refrigerators run normally until they reach a certain level of accumulation. At some point, when they are over the limit, their performance drops quickly resulting in damage to, or disposal of the stored products inside. The Self-Cleaning Condenser device keeps the condenser clean and prevents system failure by automatically brushing daily.

■ **Digital temperature control & monitor system**

Keeps food products safe by maintaining constant temperatures. External digital display allows for easy monitoring.

■ **Hydrocarbon refrigerants (R-290)**

With innovative and eco-friendly technology, Turbo Air brings you hydrocarbon refrigerators designed to meet DOE's Energy Conservation Standards in 2017 and to use EPA's SNAP Program approved HC refrigerants. Hydrocarbon refrigerants do not deplete the ozone layer and have very low contribution to global warming (ODP-0, GWP-3).

■ **Stainless steel cabinet construction**

The PRO series model boasts a stainless steel interior and a 22 gauge stainless steel exterior (galvanized steel bottom). It guarantees the utmost in cleanliness and long product life. The PRO series adds a touch of style to the most refined setting.

■ **Sturdy, clean stainless steel shelving**

Shelves are the most important part of cleanliness as they come in direct contact with food. The PRO series uniquely provides stainless steel shelving (only PWR-60-D2R(L)-N, PWR-72-D2R(L)-N).

■ **Ergonomically designed doors**

Customers' fatigue fades away with easy grip handles and doors that open effortlessly. These features along with self-closing doors make this the ultimate choice in customer convenience (only PWR-60-D2R(L)-N, PWR-72-D2R(L)-N).

■ **High-density polyurethane insulation**

The entire cabinet structure and solid doors are foamed-in-place using high density, CFC free polyurethane insulation.

■ **Spring assisted heavy duty gravity hinge**

(only PWR-60-D2R(L)-N, PWR-72-D2R(L)-N)

■ **Refrigerator holds 33°F ~ 38°F for the best in food preservation**

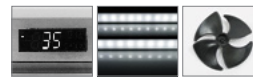

LED interior lighting & fan control

Energy efficient LED lighting lights every corner, making items easy to find. Fan control function automatically shuts off the fan when the door is open, which prevents hot air from being drawn in, thus maintaining the cool inner temperature (only PWR-60-D2R(L)-N, PWR-72-D2R(L)-N).

■ **Standard features**

- Anti-corrosion coated evaporator
- Self-contained system
- 4" dia. swivel casters with locks on the front set
- Door locks (only PWR-60-D2R(L)-N, PWR-72-D2R(L)-N)
- Lead time applies

■ **Optional features**

- Legs available for all models: 6"
- Stainless steel single overshef available
- Casters available for all models: 1", 2.5", 5"

PWR MODELS SPECIFICATIONS

ELECTRICAL DATA	PWR-60-D2R(L)-N	PWR-60-D4-N	PWR-72-D2R(L)-N	PWR-72-D4-N
Voltage	115/60/1	115/60/1	115/60/1	115/60/1
Plug Type	Ⓢ NEMA 5-15P	Ⓢ NEMA 5-15P	Ⓢ NEMA 5-15P	Ⓢ NEMA 5-15P
Full Load Amp.	8.9	8.9	9.9	9.9
Compressor HP	1/6	1/6	1/6	1/6
Cord Length (ft.)	10	10	10	10
Refrigerant	R-290	R-290	R-290	R-290
DIMENSIONAL DATA				
Net Capacity (cu. ft.)	15.5	15.5	18.8	18.8
Ext. Dimension (L x D x H†) (in.)	60 ¹ / ₄ x 30 x 34 ¹ / ₈	60 ¹ / ₄ x 30 x 34 ¹ / ₈	72 ⁵ / ₈ x 30 x 34 ¹ / ₈	72 ⁵ / ₈ x 30 x 34 ¹ / ₈
# of Doors	1	-	1	-
# of Drawers	2	4	2	4
# of Shelves	1	-	1	-
Shelf Size (L x D) (in.)	27 x 17	-	33 ¹ / ₈ x 17	-
Net Weight (lbs.)	262	295	325	360
Gross Weight (lbs.)	293	311	364	384

Design and specifications subject to change without notice. Most updated spec sheets are available at www.turboairinc.com.

Actual shipping weight may differ due to extra packing materials for product protection.

* Depth does not include 2" for door handles and rear spacers. † Height does not include 4-1/2" for caster height.

■ **WARRANTY: 5 Year Parts and Labor Warranty, 7 Year Compressor Warranty**

WORKTOP FREEZERS NATURAL Refrigerant

Self-Cleaning Condenser Equipped Units

■ **Self-Cleaning Condenser (Patented)**

The accumulation of dust in the condenser can cause the failure or breakdown of refrigerators. Refrigerators run normally until they reach a certain level of accumulation. At some point, when they are over the limit, their performance drops quickly resulting in damage to, or disposal of the stored products inside. The Self-Cleaning Condenser device keeps the condenser clean and prevents system failure by automatically brushing daily.

■ **Digital temperature control & monitor system**

Keeps food products safe by maintaining constant temperatures. External digital display allows for easy monitoring.

■ **Hydrocarbon refrigerants (R-290)**

With innovative and eco-friendly technology, Turbo Air brings you hydrocarbon refrigerators designed to meet DOE's Energy Conservation Standards in 2017 and to use EPA's SNAP Program approved HC refrigerants. Hydrocarbon refrigerants do not deplete the ozone layer and have very low contribution to global warming (ODP-0, GWP-3).

■ **Stainless steel cabinet construction**

The PRO series model boasts a stainless steel interior and a 22 gauge stainless steel exterior (galvanized steel bottom). It guarantees the utmost in cleanliness and long product life. The PRO series adds a touch of style to the most refined setting.

■ **Sturdy, clean stainless steel shelving**

Shelves are the most important part of cleanliness as they come in direct contact with food. The PRO series uniquely provides stainless steel shelving.

■ **Ergonomically designed doors**

Customers' fatigue fades away with easy grip handles and doors that open effortlessly. These features along with self-closing doors make this the ultimate choice in customer convenience.

■ **High-density polyurethane insulation**

The entire cabinet structure and solid doors are foamed-in-place using high density, CFC free polyurethane insulation.

■ **Left hinged model available (PWF-28-N-L)**

■ **Spring assisted heavy duty gravity hinge**

■ **Freezer holds -10°F ~ 0°F for the best in frozen food preservation**



PWF-60-N



PWF-28-N

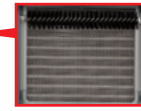

Self-Cleaning Condenser
Maintenance-free during warranty period

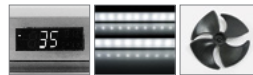

LED interior lighting & fan control

Energy efficient LED lighting lights every corner, making items easy to find. Fan control function automatically shuts off the fan when the door is open, which prevents hot air from being drawn in, thus maintaining the cool inner temperature.

■ **Standard features**

- Anti-corrosion coated evaporator
- Self-contained system
- 4" dia. swivel casters with locks on the front set
- Door locks
- Lead time applies

■ **Optional features**

- Legs available for all models: 6"
- Stainless steel single overshef available (except PWF-28-N)
- Casters available for all models: 1" (1.5" low profile caster kit for PWF-28-N), 2.5" (except PWF-28-N), 5"

PWF MODELS SPECIFICATIONS

ELECTRICAL DATA	PWF-28-N	PWF-48-N	PWF-60-N
Voltage	115/60/1	115/60/1	115/60/1
Plug Type	Ⓜ NEMA 5-15P	Ⓜ NEMA 5-15P	Ⓜ NEMA 5-15P
Full Load Amp.	4.5	8	8.0
Compressor HP	1/4	1/3	1/2
Cord Length (ft.)	10	10	10
Refrigerant	R-290	R-290	R-290
DIMENSIONAL DATA			
Net Capacity (cu. ft.)	6.8	12.8	17.2
Ext. Dimension (L x D [*] x H [†]) (in.)	27 ¹ / ₂ x 30 x 34 ¹ / ₈	48 ¹ / ₄ x 30 x 34 ¹ / ₈	60 ¹ / ₄ x 30 x 34 ¹ / ₈
# of Doors	1	2	2
# of Shelves	1	2	2
Shelf Size (L x D) (in.)	22 ¹ / ₂ x 17	21 x 17	27 x 17
Net Weight (lbs.)	155	238	258
Gross Weight (lbs.)	167	285	349

Design and specifications subject to change without notice. Most updated spec sheets are available at www.turboairinc.com.

Actual shipping weight may differ due to extra packing materials for product protection.

* Depth does not include 2" for door handles and rear spacers. † Height does not include 4-1/2" for caster height.

■ **WARRANTY: 5 Year Parts and Labor Warranty, 7 Year Compressor Warranty**

WORKTOP FREEZERS - DRAWERS NATURAL Refrigerant

Self-Cleaning Condenser Equipped Units

■ **Self-Cleaning Condenser (Patented)**

The accumulation of dust in the condenser can cause the failure or breakdown of refrigerators. Refrigerators run normally until they reach a certain level of accumulation. At some point, when they are over the limit, their performance drops quickly resulting in damage to, or disposal of the stored products inside. The Self-Cleaning Condenser device keeps the condenser clean and prevents system failure by automatically brushing daily.

■ **Digital temperature control & monitor system**

Keeps food products safe by maintaining constant temperatures. External digital display allows for easy monitoring.

■ **Hydrocarbon refrigerants (R-290)**

With innovative and eco-friendly technology, Turbo Air brings you hydrocarbon refrigerators designed to meet DOE's Energy Conservation Standards in 2017 and to use EPA's SNAP Program approved HC refrigerants. Hydrocarbon refrigerants do not deplete the ozone layer and have very low contribution to global warming (ODP-0, GWP-3).

■ **Stainless steel cabinet construction**

The PRO series model boasts a stainless steel interior and a **22 gauge** stainless steel exterior (galvanized steel bottom). It guarantees the utmost in cleanliness and long product life. The PRO series adds a touch of style to the most refined setting.

■ **Sturdy, clean stainless steel shelving**

Shelves are the most important part of cleanliness as they come in direct contact with food. The PRO series uniquely provides stainless steel shelving (only PWF-48-D2R(L)-N, PWF-60-D2R(L)-N).

■ **Ergonomically designed doors**

Customers' fatigue fades away with easy grip handles and doors that open effortlessly. These features along with self-closing doors make this the ultimate choice in customer convenience (only PWF-48-D2R(L)-N, PWF-60-D2R(L)-N).

■ **High-density polyurethane insulation**

The entire cabinet structure and solid doors are foamed-in-place using high density, CFC free polyurethane insulation.

■ **Spring assisted heavy duty gravity hinge**

■ **Freezer holds -10°F ~ 0°F for the best in frozen food preservation**

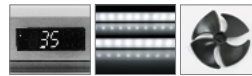

LED interior lighting & fan control

Energy efficient LED lighting lights every corner, making items easy to find. Fan control function automatically shuts off the fan when the door is open, which prevents hot air from being drawn in, thus maintaining the cool inner temperature (only PWF-48-D2R(L)-N, PWF-60-D2R(L)-N).

■ **Standard features**

- Anti-corrosion coated evaporator
- Self-contained system
- 4" dia. swivel casters with locks on the front set
- Door locks (only PWF-48-D2R(L)-N, PWF-60-D2R(L)-N)
- Lead time applies

■ **Optional features**

- Legs available for all models: 6"
- Stainless steel single overshelf available (except PWF-28-D2-N)
- Casters available for all models: 1" (1.5" low profile caster kit for PWF-28-D2-N), 2.5" (except PWF-28-D2-N), 5"

PWF MODELS SPECIFICATIONS

ELECTRICAL DATA	PWF-28-D2-N	PWF-48-D2R(L)-N	PWF-48-D4-N	PWF-60-D2R(L)-N	PWF-60-D4-N
Voltage	115/60/1	115/60/1	115/60/1	115/60/1	115/60/1
Plug Type	Ⓢ NEMA 5-15P	Ⓢ NEMA 5-15P	Ⓢ NEMA 5-15P	Ⓢ NEMA 5-15P	Ⓢ NEMA 5-15P
Full Load Amp.	4.5	8.0	8.0	5.6	5.6
Compressor HP	1/4	1/3	1/3	1/2	1/2
Cord Length (ft.)	10	10	10	10	10
Refrigerant	R-290	R-290	R-290	R-290	R-290
DIMENSIONAL DATA					
Net Capacity (cu. ft.)	6.8	12.8	12.8	17.2	17.2
Ext. Dimension (L x D [*] x H [†]) (in.)	27 1/2 x 30 x 34 1/8	48 1/4 x 30 x 34 1/8	48 1/4 x 30 x 34 1/8	60 1/4 x 30 x 34 1/8	60 1/4 x 30 x 34 1/8
# of Doors	-	1	-	1	-
# of Drawers	2	2	4	2	4
# of Shelves	-	1	-	1	-
Shelf Size (L x D) (in.)	-	21 x 17	-	27 x 17	-
Net Weight (lbs.)	228	238	245	262	295
Gross Weight (lbs.)	234	249	254	293	311

Design and specifications subject to change without notice. Most updated spec sheets are available at www.turboairinc.com.

Actual shipping weight may differ due to extra packing materials for product protection.

* Depth does not include 2" for door handles and rear spacers. † Height does not include 4-1/2" for caster height.

■ **WARRANTY: 5 Year Parts and Labor Warranty, 7 Year Compressor Warranty**

WORKTOP REFRIGERATORS - FRONT BREATHING AIRFLOW

Self-Cleaning Condenser Equipped Units

Self-Cleaning Condenser (Patented)

The accumulation of dust in the condenser can cause the failure or breakdown of refrigerators. Refrigerators run normally until they reach a certain level of accumulation. At some point, when they are over the limit, their performance drops quickly resulting in damage to, or disposal of the stored products inside. The Self-Cleaning Condenser device keeps the condenser clean and prevents system failure by automatically brushing daily.

Digital temperature control & monitor system

Keeps food products safe by maintaining constant temperatures. External digital display allows for easy monitoring.

Front Breathing airflow

Front Breathing airflow is designed to draw in air and discharge from the front, allowing units to run at high efficiency in tight spaces and eliminates the need for surrounding clearances.

Hydrocarbon refrigerants (R-290)

With innovative and eco-friendly technology, Turbo Air brings you hydrocarbon refrigerators designed to meet DOE's Energy Conservation Standards in 2017 and to use EPA's SNAP Program approved HC refrigerants. Hydrocarbon refrigerants do not deplete the ozone layer and have very low contribution to global warming (ODP-0, GWP-3).

Stainless steel cabinet construction

The PRO series model boasts a stainless steel interior and a 22 gauge stainless steel exterior (galvanized steel bottom). It guarantees the utmost in cleanliness and long product life. The PRO series adds a touch of style to the most refined setting.

Sturdy, clean stainless steel shelving

Shelves are the most important part of cleanliness as they come in direct contact with food. The PRO series uniquely provides stainless steel shelving.

Ergonomically designed doors

Customers' fatigue fades away with easy grip handles and doors that open effortlessly. These features along with self-closing doors make this the ultimate choice in customer convenience.

High-density polyurethane insulation

The entire cabinet structure and solid doors are foamed-in-place using high density, CFC free polyurethane insulation.

Spring assisted heavy duty gravity hinge

Refrigerator holds 33°F ~ 38°F for the best in food preservation

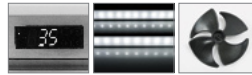

LED interior lighting & fan control

Energy efficient LED lighting lights every corner, making items easy to find. Fan control function automatically shuts off the fan when the door is open, which prevents hot air from being drawn in, thus maintaining the cool inner temperature.

Standard features

- Anti-corrosion coated evaporator
- Self-contained system
- 4" dia. swivel casters with locks on the front set
- Door locks
- Lead time applies

Optional features

- Legs available for all models: 6"
- Stainless steel single overshelf available (except PWR-28-FB-N)
- Casters available for all models: 1" (1.5" low profile caster kit for PWR-28-FB-N), 2.5"(except PWR-28-FB-N), 5"

PWR MODELS SPECIFICATIONS

ELECTRICAL DATA	PWR-28-FB-N	PWR-48-FB-N	PWR-60-FB-N	PWR-72-FB-N
Voltage	115/60/1	115/60/1	115/60/1	115/60/1
Plug Type	Ⓜ NEMA 5-15P	Ⓜ NEMA 5-15P	Ⓜ NEMA 5-15P	Ⓜ NEMA 5-15P
Full Load Amp.	6.6	6.5	8.9	9.9
Compressor HP	1/6	1/6	1/6	1/6
Cord Length (ft.)	10	10	10	10
Refrigerant	R-290	R-290	R-290	R-290
DIMENSIONAL DATA				
Net Capacity (cu. ft.)	6.5	9.8	14.8	17.6
Ext. Dimension (L x D x H†) (in.)	27 1/2 x 30 x 34 1/8	48 1/4 x 30 x 34 1/8	60 1/4 x 30 x 34 1/8	72 5/8 x 30 x 34 1/8
# of Doors	1	2	2	2
# of Shelves	1	2	2	2
Shelf Size (L x D) (in.)	22 1/2 x 17	21 x 17	27 x 17	33 1/8 x 17
Net Weight (lbs.)	155	238	258	320
Gross Weight (lbs.)	167	285	349	355

Design and specifications subject to change without notice. Most updated spec sheets are available at www.turboairinc.com.

Actual shipping weight may differ due to extra packing materials for product protection.

* Depth does not include 3/4" for door handles. † Height does not include 4-1/2" for caster height.

WARRANTY: 5 Year Parts and Labor Warranty, 7 Year Compressor Warranty

Self-Cleaning Condenser Equipped Units

■ **Self-Cleaning Condenser (Patented)**

The accumulation of dust in the condenser can cause the failure or breakdown of refrigerators. Refrigerators run normally until they reach a certain level of accumulation. At some point, when they are over the limit, their performance drops quickly resulting in damage to, or disposal of the stored products inside. The Self-Cleaning Condenser device keeps the condenser clean and prevents system failure by automatically brushing daily.

■ **Digital temperature control & monitor system**

Keeps food products safe by maintaining constant temperatures. External digital display allows for easy monitoring.

■ **Front Breathing airflow**

Front Breathing airflow is designed to draw in air and discharge from the front, allowing units to run at high efficiency in tight spaces and eliminates the need for surrounding clearances.

■ **Hydrocarbon refrigerants (R-290)**

With innovative and eco-friendly technology, Turbo Air brings you hydrocarbon refrigerators designed to meet DOE's Energy Conservation Standards in 2017 and to use EPA's SNAP Program approved HC refrigerants. Hydrocarbon refrigerants do not deplete the ozone layer and have very low contribution to global warming (ODP-0, GWP-3).

■ **Stainless steel cabinet construction**

The PRO series model boasts a stainless steel interior and a 22 gauge stainless steel exterior (galvanized steel bottom). It guarantees the utmost in cleanliness and long product life. The PRO series adds a touch of style to the most refined setting.

■ **Sturdy, clean stainless steel shelving**

Shelves are the most important part of cleanliness as they come in direct contact with food. The PRO series uniquely provides stainless steel shelving (only PWR-48-D2R(L)-FB-N).

■ **Ergonomically designed doors**

Customers' fatigue fades away with easy grip handles and doors that open effortlessly. These features along with self-closing doors make this the ultimate choice in customer convenience (only PWR-48-D2R(L)-FB-N).

■ **High-density polyurethane insulation**

The entire cabinet structure and solid doors are foamed-in-place using high density, CFC free polyurethane insulation.

■ **Spring assisted heavy duty gravity hinge (only PWR-48-D2R(L)-FB-N)**

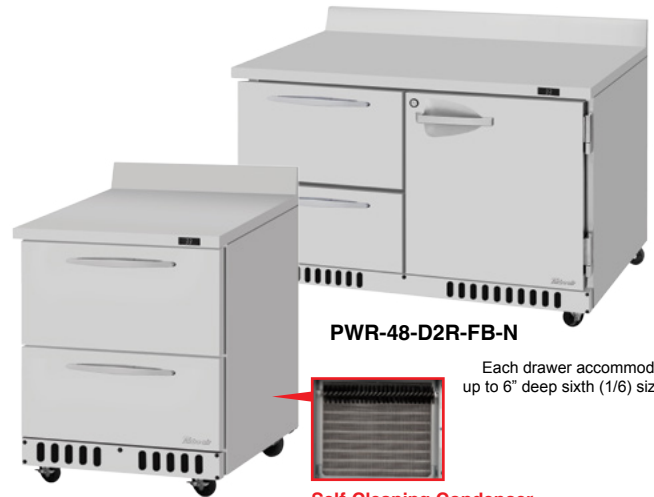

LED interior lighting & fan control
Energy efficient LED lighting lights every corner, making items easy to find. Fan control function automatically shuts off the fan when the door is open, which prevents hot air from being drawn in, thus maintaining the cool inner temperature (only PWR-48-D2R(L)-N).

■ **Refrigerator holds 33°F ~ 38°F for the best in food preservation**

■ **Standard features**

- Anti-corrosion coated evaporator
- Self-contained system
- 4" dia. swivel casters with locks on the front set
- Door locks (only PWR-48-D2R(L)-FB-N)
- Lead time applies

■ **Optional features**

- Legs available for all models: 6"
- Stainless steel single overshef available (except PWR-28-D2-FB-N)
- Casters available for all models: 1" (1.5" low profile caster kit for PWR-28-D2-FB-N), 2.5" (except PWR-28-D2-FB-N), 5"

PWR MODELS SPECIFICATIONS

ELECTRICAL DATA	PWR-28-D2-FB-N	PWR-48-D2R(L)-FB-N	PWR-48-D4-FB-N	PWR-60-FB-N
Voltage	115/60/1	115/60/1	115/60/1	115/60/1
Plug Type	Ⓜ NEMA 5-15P	Ⓜ NEMA 5-15P	Ⓜ NEMA 5-15P	Ⓜ NEMA 5-15P
Full Load Amp.	6.6	6.5	6.5	8.9
Compressor HP	1/6	1/6	1/6	1/6
Cord Length (ft.)	10	10	10	10
Refrigerant	R-290	R-290	R-290	R-290
DIMENSIONAL DATA				
Net Capacity (cu. ft.)	6.5	9.8	9.8	14.8
Ext. Dimension (L x D [*] x H [†]) (in.)	27 1/2 x 30 x 34 1/8	48 1/4 x 30 x 34 1/8	48 1/4 x 30 x 34 1/8	60 1/4 x 30 x 34 1/8
# of Doors	-	1	-	2
# of Drawers	2	2	4	-
# of Shelves	-	1	-	2
Shelf Size (L x D) (in.)	-	21 x 17	-	27 x 17
Net Weight (lbs.)	228	238	245	258
Gross Weight (lbs.)	234	285	254	349

Design and specifications subject to change without notice. Most updated spec sheets are available at www.turboairinc.com.

Actual shipping weight may differ due to extra packing materials for product protection.

* Depth does not include 1-1/2" for door handles. † Height does not include 4-1/2" for caster height.

■ **WARRANTY: 5 Year Parts and Labor Warranty, 7 Year Compressor Warranty**

WORKTOP REF. - FRONT BREATHING AIRFLOW/DRAWERS

Self-Cleaning Condenser Equipped Units

■ **Self-Cleaning Condenser (Patented)**

The accumulation of dust in the condenser can cause the failure or breakdown of refrigerators. Refrigerators run normally until they reach a certain level of accumulation. At some point, when they are over the limit, their performance drops quickly resulting in damage to, or disposal of the stored products inside. The Self-Cleaning Condenser device keeps the condenser clean and prevents system failure by automatically brushing daily.

■ **Digital temperature control & monitor system**

Keeps food products safe by maintaining constant temperatures. External digital display allows for easy monitoring.

■ **Front Breathing airflow**

Front Breathing airflow is designed to draw in air and discharge from the front, allowing units to run at high efficiency in tight spaces and eliminates the need for surrounding clearances.

■ **Hydrocarbon refrigerants (R-290)**

With innovative and eco-friendly technology, Turbo Air brings you hydrocarbon refrigerators designed to meet DOE's Energy Conservation Standards in 2017 and to use EPA's SNAP Program approved HC refrigerants. Hydrocarbon refrigerants do not deplete the ozone layer and have very low contribution to global warming (ODP-0, GWP-3).

■ **Stainless steel cabinet construction**

The PRO series model boasts a stainless steel interior and a 22 gauge stainless steel exterior (galvanized steel bottom). It guarantees the utmost in cleanliness and long product life. The PRO series adds a touch of style to the most refined setting.

■ **Sturdy, clean stainless steel shelving**

Shelves are the most important part of cleanliness as they come in direct contact with food. The PRO series uniquely provides stainless steel shelving (only PWR-60-D2R(L)-FB-N, PWR-70-D2R(L)-FB-N).

■ **Ergonomically designed doors**

Customers' fatigue fades away with easy grip handles and doors that open effortlessly. These features along with self-closing doors make this the ultimate choice in customer convenience (only PWR-60-D2R(L)-FB-N, PWR-70-D2R(L)-FB-N).

■ **High-density polyurethane insulation**

The entire cabinet structure and solid doors are foamed-in-place using high density, CFC free polyurethane insulation.

■ **Spring assisted heavy duty gravity hinge (only PWR-60-D2R(L)-FB-N, PWR-72-D2R(L)-FB-N)**

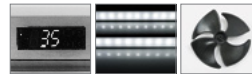

LED interior lighting & fan control
Energy efficient LED lighting lights every corner, making items easy to find. Fan control function automatically shuts off the fan when the door is open, which prevents hot air from being drawn in, thus maintaining the cool inner temperature (only PWR-60-D2R(L)-FB-N, PWR-70-D2R(L)-FB-N).

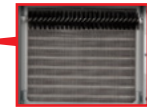

Self-Cleaning Condenser
Maintenance-free during warranty period

■ **Refrigerator holds 33°F ~ 38°F for the best in food preservation**

■ **Standard features**

- Anti-corrosion coated evaporator
- Self-contained system
- 4" dia. swivel casters with locks on the front set
- Door locks (only PWR-60-D2R(L)-FB-N, PWR-72-D2R(L)-FB-N)
- Lead time applies

■ **Optional features**

- Legs available for all models: 6"
- Stainless steel single overshef available
- Casters available for all models: 1", 2.5", 5"

PWR MODELS SPECIFICATIONS

ELECTRICAL DATA	PWR-60-D2R(L)-FB-N	PWR-60-D4-FB-N	PWR-72-D2R(L)-FB-N	PWR-72-D4-FB-N
Voltage	115/60/1	115/60/1	115/60/1	115/60/1
Plug Type	Ⓢ NEMA 5-15P	Ⓢ NEMA 5-15P	Ⓢ NEMA 5-15P	Ⓢ NEMA 5-15P
Full Load Amp.	8.9	8.9	9.9	9.9
Compressor HP	1/6	1/6	1/6	1/6
Cord Length (ft.)	10	10	10	10
Refrigerant	R-290	R-290	R-290	R-290
DIMENSIONAL DATA				
Net Capacity (cu. ft.)	14.8	14.8	17.6	17.6
Ext. Dimension (L x D* x H†) (in.)	60 1/4 x 30 x 34 1/8	60 1/4 x 30 x 34 1/8	72 5/8 x 30 x 34 1/8	72 5/8 x 30 x 34 1/8
# of Doors	1	-	1	-
# of Drawers	2	4	2	4
# of Shelves	1	-	1	-
Shelf Size (L x D) (in.)	27 x 17	-	33 1/8 x 17	-
Net Weight (lbs.)	262	295	325	360
Gross Weight (lbs.)	293	311	364	384

Design and specifications subject to change without notice. Most updated spec sheets are available at www.turboairinc.com.

Actual shipping weight may differ due to extra packing materials for product protection.

* Depth does not include 3/4" for door handles. † Height does not include 4-1/2" for caster height.

■ **WARRANTY: 5 Year Parts and Labor Warranty, 7 Year Compressor Warranty**

WORKTOP FREEZER - FRONT BREATHING AIRFLOW NATURAL Refrigerant

Self-Cleaning Condenser Equipped Units

■ **Self-Cleaning Condenser (Patented)**

The accumulation of dust in the condenser can cause the failure or breakdown of refrigerators. Refrigerators run normally until they reach a certain level of accumulation. At some point, when they are over the limit, their performance drops quickly resulting in damage to, or disposal of the stored products inside. The Self-Cleaning Condenser device keeps the condenser clean and prevents system failure by automatically brushing daily.

■ **Digital temperature control & monitor system**

Keeps food products safe by maintaining constant temperatures. External digital display allows for easy monitoring.

■ **Front Breathing airflow**

Front Breathing airflow is designed to draw in air and discharge from the front, allowing units to run at high efficiency in tight spaces and eliminates the need for surrounding clearances.

■ **Hydrocarbon refrigerants (R-290)**

With innovative and eco-friendly technology, Turbo Air brings you hydrocarbon refrigerators designed to meet DOE's Energy Conservation Standards in 2017 and to use EPA's SNAP Program approved HC refrigerants. Hydrocarbon refrigerants do not deplete the ozone layer and have very low contribution to global warming (ODP-0, GWP-3).

■ **Stainless steel cabinet construction**

The PRO series model boasts a stainless steel interior and a 22 gauge stainless steel exterior (galvanized steel bottom). It guarantees the utmost in cleanliness and long product life. The PRO series adds a touch of style to the most refined setting.

■ **Sturdy, clean stainless steel shelving**

Shelves are the most important part of cleanliness as they come in direct contact with food. The PRO series uniquely provides stainless steel shelving.

■ **Ergonomically designed doors**

Customers' fatigue fades away with easy grip handles and doors that open effortlessly. These features along with self-closing doors make this the ultimate choice in customer convenience.

■ **High-density polyurethane insulation**

The entire cabinet structure and solid doors are foamed-in-place using high density, CFC free polyurethane insulation.

■ **Spring assisted heavy duty gravity hinge**

■ **Freezer holds -10°F ~ 0°F for the best in food preservation**

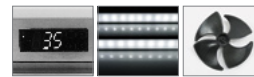

LED interior lighting & fan control

Energy efficient LED lighting lights every corner, making items easy to find. Fan control function automatically shuts off the fan when the door is open, which prevents hot air from being drawn in, thus maintaining the cool inner temperature.

■ **Standard features**

- Anti-corrosion coated evaporator
- Self-contained system
- 4" dia. swivel casters with locks on the front set
- Door locks
- Lead time applies

■ **Optional features**

- Legs available for all models: 6"
- Stainless steel single overshelf available (except PWF-28-FB-N)
- Casters available for all models: 1" (1.5" low profile caster kit for PWF-28-FB-N), 2.5" (except PWF-28-FB-N), 5"

PWF MODELS SPECIFICATIONS

ELECTRICAL DATA	PWF-28-FB-N	PWF-48-FB-N	PWF-60-FB-N
Voltage	115/60/1	115/60/1	115/60/1
Plug Type	Ⓜ NEMA 5-15P	Ⓜ NEMA 5-15P	Ⓜ NEMA 5-15P
Full Load Amp.	4.5	8	8
Compressor HP	1/4	1/3	1/2
Cord Length (ft.)	10	10	10
Refrigerant	R-290	R-290	R-290
DIMENSIONAL DATA			
Net Capacity (cu. ft.)	6.5	11.1	14.8
Ext. Dimension (L x D* x H†) (in.)	27 1/2 x 30 x 34 1/8	48 1/4 x 30 x 34 1/8	60 1/4 x 30 x 34 1/8
# of Doors	1	2	2
# of Shelves	1	2	2
Shelf Size (L x D) (in.)	22 1/2 x 17	21 x 17	27 x 17
Net Weight (lbs.)	155	238	258
Gross Weight (lbs.)	167	285	379

Design and specifications subject to change without notice. Most updated spec sheets are available at www.turboairinc.com.

Actual shipping weight may differ due to extra packing materials for product protection.

* Depth does not include 3/4" for door handles. † Height does not include 4-1/2" for caster height.

■ **WARRANTY: 5 Year Parts and Labor Warranty, 7 Year Compressor Warranty**

WORKTOP FREEZERS - FRONT BREATHING AIRFLOW/DRAWERS

Self-Cleaning Condenser Equipped Units

■ **Self-Cleaning Condenser (Patented)**

The accumulation of dust in the condenser can cause the failure or breakdown of refrigerators. Refrigerators run normally until they reach a certain level of accumulation. At some point, when they are over the limit, their performance drops quickly resulting in damage to, or disposal of the stored products inside. The Self-Cleaning Condenser device keeps the condenser clean and prevents system failure by automatically brushing daily.

■ **Digital temperature control & monitor system**

Keeps food products safe by maintaining constant temperatures. External digital display allows for easy monitoring.

■ **Front Breathing airflow**

Front Breathing airflow is designed to draw in air and discharge from the front, allowing units to run at high efficiency in tight spaces and eliminates the need for surrounding clearances.

■ **Hydrocarbon refrigerants (R-290)**

With innovative and eco-friendly technology, Turbo Air brings you hydrocarbon refrigerators designed to meet DOE's Energy Conservation Standards in 2017 and to use EPA's SNAP Program approved HC refrigerants. Hydrocarbon refrigerants do not deplete the ozone layer and have very low contribution to global warming (ODP-0, GWP-3).

■ **Stainless steel cabinet construction**

The PRO series model boasts a stainless steel interior and a 22 gauge stainless steel exterior (galvanized steel bottom). It guarantees the utmost in cleanliness and long product life. The PRO series adds a touch of style to the most refined setting.

■ **Sturdy, clean stainless steel shelving**

Shelves are the most important part of cleanliness as they come in direct contact with food. The PRO series uniquely provides stainless steel shelving (only PWF-48-D2R(L)-FB-N, PWF-60-D2R(L)-FB-N).

■ **Ergonomically designed doors**

Customers' fatigue fades away with easy grip handles and doors that open effortlessly. These features along with self-closing doors make this the ultimate choice in customer convenience (only PWF-48-D2R(L)-FB-N, PWF-60-D2R(L)-FB-N).

■ **High-density polyurethane insulation**

The entire cabinet structure and solid doors are foamed-in-place using high density, CFC free polyurethane insulation.

■ **Spring assisted heavy duty gravity hinge (only PWF-48-D2R(L)-FB-N, PWF-60-D2R(L)-FB-N)**

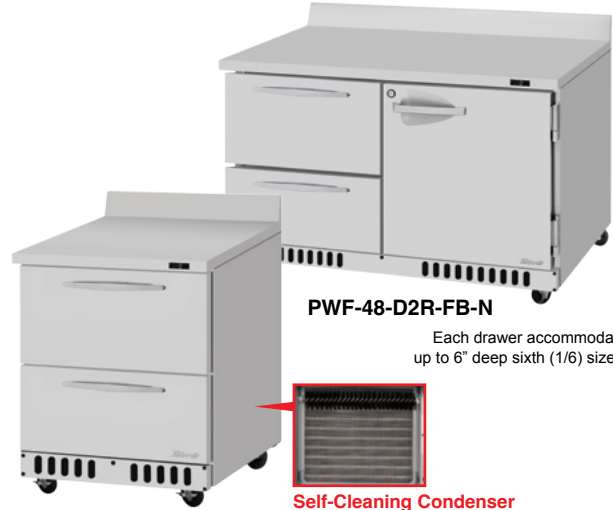

PWF-48-D2R-FB-N

Each drawer accommodates up to 6" deep sixth (1/6) size pans

PWF-28-D2-FB-N

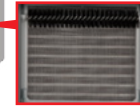

Self-Cleaning Condenser Maintenance-free during warranty period

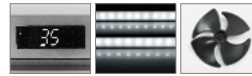

LED interior lighting & fan control

Energy efficient LED lighting lights every corner, making items easy to find. Fan control function automatically shuts off the fan when the door is open, which prevents hot air from being drawn in, thus maintaining the cool inner temperature (only PWF-48-D2R(L)-N, PWF-60-D2R(L)-FB-N).

■ **Freezer holds -10°F ~ 0°F for the best in food preservation**

■ **Standard features**

- Anti-corrosion coated evaporator
- Self-contained system
- 4" dia. swivel casters with locks on the front set
- Door locks (only PWF-48-D2R(L)-FB-N, PWF-60-D2R(L)-FB-N)
- Lead time applies

■ **Optional features**

- Legs available for all models: 6"
- Stainless steel single overshelf available (except PWF-28-D2-FB-N)
- Casters available for all models: 1" (1.5" low profile caster kit for PWF-28-D2-FB-N), 2.5" (except PWF-28-D2-FB-N), 5"

PWF MODELS SPECIFICATIONS

ELECTRICAL DATA	PWF-28-D2-FB-N	PWF-48-D2R(L)-FB-N	PWF-48-D4-FB-N	PWF-60-D2R(L)-FB-N	PWF-60-D4-FB-N
Voltage	115/60/1	115/60/1	115/60/1	115/60/1	115/60/1
Plug Type	Ⓢ NEMA 5-15P	Ⓢ NEMA 5-15P	Ⓢ NEMA 5-15P	Ⓢ NEMA 5-15P	Ⓢ NEMA 5-15P
Full Load Amp.	4.5	8	8	5.6	5.6
Compressor HP	1/4	1/3	1/3	1/2	1/2
Cord Length (ft.)	10	10	10	10	10
Refrigerant	R-290	R-290	R-290	R-290	R-290
DIMENSIONAL DATA					
Net Capacity (cu. ft.)	6.5	11.1	11.1	14.8	14.8
Ext. Dimension (L x D* x H†) (in.)	27 1/2 x 30 x 34 1/8	48 1/4 x 30 x 34 1/8	48 1/4 x 30 x 34 1/8	60 1/4 x 30 x 34 1/8	60 1/4 x 30 x 34 1/8
# of Doors	-	1	-	1	-
# of Drawers	2	2	4	2	4
# of Shelves	-	1	-	1	-
Shelf Size (L x D) (in.)	-	21 x 17	-	27 x 17	-
Net Weight (lbs.)	228	238	245	262	295
Gross Weight (lbs.)	234	249	254	293	311

Design and specifications subject to change without notice. Most updated spec sheets are available at www.turboairinc.com.

Actual shipping weight may differ due to extra packing materials for product protection.

* Depth does not include 1-1/2" for door handles. † Height does not include 4-1/2" for caster height.

■ **WARRANTY: 5 Year Parts and Labor Warranty, 7 Year Compressor Warranty**

WORKTOP REFRIGERATORS NATURAL Refrigerant

Self-Cleaning Condenser Equipped Units

■ **Self-Cleaning Condenser (Patented)**

The accumulation of dust in the condenser can cause the failure or breakdown of refrigerators. Refrigerators run normally until they reach a certain level of accumulation. At some point, when they are over the limit, their performance drops quickly resulting in damage to, or disposal of the stored products inside. The Self-Cleaning Condenser device keeps the condenser clean and prevents system failure by automatically brushing daily.

■ **Digital temperature control & monitor system**

Keeps food products safe by maintaining constant temperatures. External digital display allows for easy monitoring.

■ **Hydrocarbon refrigerants (R-290 / R-600a)**

With innovative and eco-friendly technology, Turbo Air brings you hydrocarbon refrigerators designed to meet DOE's Energy Conservation Standards in 2017 and to use EPA's SNAP Program approved HC refrigerants. Hydrocarbon refrigerants do not deplete the ozone layer and have very low contribution to global warming (ODP-0, GWP-3).

■ **Stainless steel cabinet construction**

The Turbo Air Super Deluxe model boasts a stainless steel interior and exterior (galvanized steel back & bottom). It guarantees the utmost in cleanliness and long product life. The Super Deluxe adds a touch of style to the most refined setting.

■ **Sturdy, clean stainless steel shelving**

Shelves are the most important part of cleanliness as they come in direct contact with food. After a while, PVC coated wire shelves may peel, rust and lead to unsanitary conditions. The Super Deluxe series uniquely provides stainless steel shelving.

■ **Ergonomically designed doors**

Customers' fatigue fades away with easy grip handles and doors that open effortlessly. These features along with self-closing doors make this the ultimate choice in customer convenience. ABS sheet door liners resist water condensation with thermal efficiency.

■ **Refrigerator holds 33°F ~ 38°F for the best in food preservation**

■ **Standard features**

- Anti-corrosion coated evaporator
- Self-contained system
- 4" dia. swivel casters with locks on the front set
- High-density polyurethane insulation
- Magnetic door gaskets
- Door locks



TWR-60SD-N



TWR-36SD-N6



TWR-28SD-N

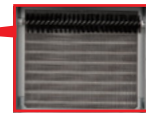

Self-Cleaning Condenser
Maintenance-free during warranty period

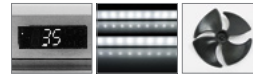

LED interior lighting & fan control

Energy efficient LED lighting lights every corner, making items easy to find. Fan control function automatically shuts off the fan when the door is open, which prevents hot air from being drawn in, thus maintaining the cool inner temperature.

■ **Optional features**

- Casters available for all models: 1", 2.5", 5"
- Legs available for all models: 6"
- Stainless steel single overshef available (except TWR-28SD-N, TWR-36SD-N6)

TWR MODELS SPECIFICATIONS

ELECTRICAL DATA	TWR-28SD-N	TWR-36SD-N6	TWR-48SD-N	TWR-60SD-N	TWR-72SD-N
Voltage	115/60/1	115/60/1	115/60/1	115/60/1	115/60/1
Plug Type	Ⓢ NEMA 5-15P	Ⓢ NEMA 5-15P	Ⓢ NEMA 5-15P	Ⓢ NEMA 5-15P	Ⓢ NEMA 5-15P
Full Load Amp.	2.2	2.3	2.5	2.4	2.5
Compressor HP	1/6	1/5	1/6	1/6	1/6
Cord Length (ft.)	9	9	9	9	9
Refrigerant	R-290	R-600a	R-290	R-290	R-290
DIMENSIONAL DATA					
Net Capacity (cu. ft.)	6.8	9	12	17	19
Ext. Dimension (L x D x H) (in.)	27 1/2 x 30* x 34 1/8†	36 3/8 x 30* x 34 1/8†	48 1/4 x 30* x 34 1/8†	60 1/4 x 30* x 34 1/8†	72 5/8 x 30* x 34 1/8‡
# of Doors	1	2	2	2	3
# of Shelves	1	2	2	2	3
Shelf Size (L x D) (in.)	22 1/2 x 17	15 x 17	21 x 17	27 x 17	21 x 17 (L/R), 23 x 17 (M)
Net Weight (lbs.)	157	178	235	254	314
Gross Weight (lbs.)	175	198	258	293	363

Design and specifications subject to change without notice. Most updated spec sheets are available at www.turboairinc.com.

Actual shipping weight may differ due to extra packing materials for product protection.

* Depth does not include 1" for rear spacers. † Height does not include 5" for caster height. ‡ Height does not include 4-3/4" for caster height.

■ **WARRANTY: 5 Year Parts and Labor Warranty, 7 Year Compressor Warranty**

WORKTOP REFRIGERATORS NATURAL Refrigerant

Self-Cleaning Condenser Equipped Units

■ **Self-Cleaning Condenser (Patented)**

The accumulation of dust in the condenser can cause the failure or breakdown of refrigerators. Refrigerators run normally until they reach a certain level of accumulation. At some point, when they are over the limit, their performance drops quickly resulting in damage to, or disposal of the stored products inside. The Self-Cleaning Condenser device keeps the condenser clean and prevents system failure by automatically brushing daily.

■ **Digital temperature control & monitor system**

Keeps food products safe by maintaining constant temperatures. External digital display allows for easy monitoring.

■ **Hydrocarbon refrigerants (R-290 / R-600a)**

With innovative and eco-friendly technology, Turbo Air brings you hydrocarbon refrigerators designed to meet DOE's Energy Conservation Standards in 2017 and to use EPA's SNAP Program approved HC refrigerants. Hydrocarbon refrigerants do not deplete the ozone layer and have very low contribution to global warming (ODP-0, GWP-3).

■ **Stainless steel cabinet construction**

The Turbo Air Super Deluxe model boasts a stainless steel interior and exterior (galvanized steel back & bottom). It guarantees the utmost in cleanliness and long product life. The Super Deluxe adds a touch of style to the most refined setting.

■ **Sturdy, clean stainless steel shelving**

Shelves are the most important part of cleanliness as they come in direct contact with food. After a while, PVC coated wire shelves may peel, rust and lead to unsanitary conditions. The Super Deluxe series uniquely provides stainless steel shelving.

■ **Ergonomically designed doors**

Customers' fatigue fades away with easy grip handles and doors that open effortlessly. These features along with self-closing doors make this the ultimate choice in customer convenience. ABS sheet door liners resist water condensation with thermal efficiency.

■ **Refrigerator holds 33°F ~ 38°F for the best in food preservation**

■ **9-1/2" deep, 1/2" thick high-density Polyethylene cutting board included with convenient side rail**

■ **High-density polyurethane insulation**



TWR-60SD-N-CB



Self-Cleaning Condenser
Maintenance-free during warranty period



LED interior lighting & fan control

Energy efficient LED lighting lights every corner, making items easy to find. Fan control function automatically shuts off the fan when the door is open, which prevents hot air from being drawn in, thus maintaining the cool inner temperature.

■ **Magnetic door gaskets**

Magnetic door gaskets are of one-piece construction, removable without tools for ease of cleaning and replacement.

■ **Standard features**

- Anti-corrosion coated evaporator
- Self-contained system
- 4" dia. swivel casters with locks on the front set
- High-density polyurethane insulation
- Door locks

■ **Optional features**

- Casters available for all models: 1", 2.5", 5"
- Legs available for all models: 6"
- Stainless steel single overshef available

TWR MODELS SPECIFICATIONS

ELECTRICAL DATA	TWR-60SD-N-CB
Voltage	115/60/1
Plug Type	Ⓜ NEMA 5-15P
Full Load Amp.	2.4
Compressor HP	1/5
Cord Length (ft.)	9
Refrigerant	R-290
DIMENSIONAL DATA	
Net Capacity (cu. ft.)	17
Ext. Dimension (L x D x H) (in.)	60 ^{1/4} x 30 x 34 ^{1/8}
# of Doors	2
# of Shelves	2
Shelf Size (L x D) (in.)	27 x 17
Net Weight (lbs.)	254
Gross Weight (lbs.)	293

Design and specifications subject to change without notice. Most updated spec sheets are available at www.turboairinc.com.

Actual shipping weight may differ due to extra packing materials for product protection.

* Depth does not include 1" for rear spacers. † Height does not include 4-1/2" for caster height.

■ **WARRANTY: 5 Year Parts and Labor Warranty, 7 Year Compressor Warranty**

WORKTOP REFRIGERATORS - DRAWERS NATURAL Refrigerant

Self-Cleaning Condenser Equipped Units

■ **Self-Cleaning Condenser (Patented)**

The accumulation of dust in the condenser can cause the failure or breakdown of refrigerators. Refrigerators run normally until they reach a certain level of accumulation. At some point, when they are over the limit, their performance drops quickly resulting in damage to, or disposal of the stored products inside. The Self-Cleaning Condenser device keeps the condenser clean and prevents system failure by automatically brushing daily.

■ **Digital temperature control & monitor system**

Keeps food products safe by maintaining constant temperatures. External digital display allows for easy monitoring.

■ **Hydrocarbon refrigerants (R-290)**

With innovative and eco-friendly technology, Turbo Air brings you hydrocarbon refrigerators designed to meet DOE's Energy Conservation Standards in 2017 and to use EPA's SNAP Program approved HC refrigerants. Hydrocarbon refrigerants do not deplete the ozone layer and have very low contribution to global warming (ODP-0, GWP-3).

■ **Stainless steel cabinet construction**

The Turbo Air Super Deluxe model boasts a stainless steel interior and exterior (galvanized steel back & bottom). It guarantees the utmost in cleanliness and long product life. The Super Deluxe adds a touch of style to the most refined setting.

■ **Sturdy, clean stainless steel shelving**

Shelves are the most important part of cleanliness as they come in direct contact with food. After a while, PVC coated wire shelves may peel, rust and lead to unsanitary conditions. The Super Deluxe series uniquely provides stainless steel shelving (only TWR-48SD-D2-N).

■ **Ergonomically designed doors**

Customers' fatigue fades away with easy grip handles and doors that open effortlessly. These features along with self-closing doors make this the ultimate choice in customer convenience. ABS sheet door liners resist water condensation with thermal efficiency (only TWR-48SD-D2-N).

■ **High-density polyurethane insulation**

The entire cabinet structure and solid doors are foamed-in-place using high density, CFC free polyurethane insulation.

■ **Refrigerator holds 33°F ~ 38°F for the best in food preservation**

Each drawer accommodates up to 6" deep sixth (1/6) size pans (drawer pans not included)



■ **Standard features**

- Anti-corrosion coated evaporator
- Self-contained system
- 4" dia. swivel casters with locks on the front set

■ **Optional features**

- Casters available for all models: 1", 2.5", 5"
- Legs available for all models: 6"
- Stainless steel single overshef available (except TWR-28SD-D2-N)

TWR MODELS SPECIFICATIONS

ELECTRICAL DATA	TWR-28SD-D2-N	TWR-48SD-D2-N	TWR-48SD-D4-N
Voltage	115/60/1	115/60/1	115/60/1
Plug Type	Ⓜ NEMA 5-15P	Ⓜ NEMA 5-15P	Ⓜ NEMA 5-15P
Full Load Amp.	2.2	2.5	2.5
Compressor HP	1/6	1/3	1/3
Cord Length (ft.)	9	9	9
Refrigerant	R-290	R-290	R-290
DIMENSIONAL DATA			
Net Capacity (cu. ft.)	7	12	12
Ext. Dimension (L x D [*] x H [†]) (in.)	27 ^{1/2} x 30 x 34 ^{1/8}	48 ^{1/4} x 30 x 34 ^{1/8}	48 ^{1/4} x 30 x 34 ^{1/8}
# of Doors	-	1	-
# of Drawers	2	2	4
# of Shelves	-	1	-
Shelf Size (L x D) (in.)	-	21 x 17	-
Net Weight (lbs.)	163	242	249
Gross Weight (lbs.)	180	264	271

Design and specifications subject to change without notice. Most updated spec sheets are available at www.turboairinc.com.

Actual shipping weight may differ due to extra packing materials for product protection.

* Depth does not include 1" for rear spacers. † Height does not include 5" for caster height.

■ **WARRANTY: 5 Year Parts and Labor Warranty, 7 Year Compressor Warranty**

WORKTOP REFRIGERATORS - DRAWERS NATURAL Refrigerant

Self-Cleaning Condenser Equipped Units

■ **Self-Cleaning Condenser (Patented)**

The accumulation of dust in the condenser can cause the failure or breakdown of refrigerators. Refrigerators run normally until they reach a certain level of accumulation. At some point, when they are over the limit, their performance drops quickly resulting in damage to, or disposal of the stored products inside. The Self-Cleaning Condenser device keeps the condenser clean and prevents system failure by automatically brushing daily.

■ **Digital temperature control & monitor system**

Keeps food products safe by maintaining constant temperatures. External digital display allows for easy monitoring.

■ **Hydrocarbon refrigerants (R-290)**

With innovative and eco-friendly technology, Turbo Air brings you hydrocarbon refrigerators designed to meet DOE's Energy Conservation Standards in 2017 and to use EPA's SNAP Program approved HC refrigerants. Hydrocarbon refrigerants do not deplete the ozone layer and have very low contribution to global warming (ODP-0, GWP-3).

■ **Stainless steel cabinet construction**

The Turbo Air Super Deluxe model boasts a stainless steel interior and exterior (galvanized steel back & bottom). It guarantees the utmost in cleanliness and long product life. The Super Deluxe adds a touch of style to the most refined setting.

■ **Sturdy, clean stainless steel shelving**

Shelves are the most important part of cleanliness as they come in direct contact with food. After a while, PVC coated wire shelves may peel, rust and lead to unsanitary conditions. The Super Deluxe series uniquely provides stainless steel shelving (only TWR-60SD-D2-N).

■ **Ergonomically designed doors**

Customers' fatigue fades away with easy grip handles and doors that open effortlessly. These features along with self-closing doors make this the ultimate choice in customer convenience. ABS sheet door liners resist water condensation with thermal efficiency (only TWR-60SD-D2-N).

■ **High-density polyurethane insulation**

The entire cabinet structure and solid doors are foamed-in-place using high density, CFC free polyurethane insulation.

■ **Refrigerator holds 33°F ~ 38°F for the best in food preservation**



TWR-60SD-D2-N
Each drawer accommodates up to 6" deep sixth (1/6) size pans (drawer pans not included)

Self-Cleaning Condenser
Maintenance-free during warranty period

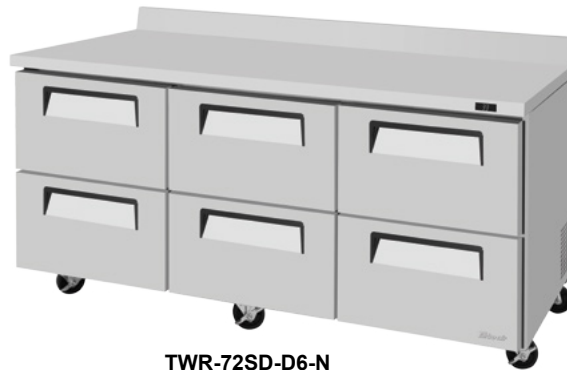

TWR-72SD-D6-N

■ **Standard features**

- Anti-corrosion coated evaporator
- Self-contained system
- 4" dia. swivel casters with locks on the front set

■ **Optional features**

- Casters available for all models: 1", 2.5", 5"
- Legs available for all models: 6"
- Stainless steel single overshelf available

TWR MODELS SPECIFICATIONS

ELECTRICAL DATA	TWR-60SD-D2-N	TWR-60SD-D4-N	TWR-72SD-D6-N
Voltage	115/60/1	115/60/1	115/60/1
Plug Type	Ⓜ NEMA 5-15P	Ⓜ NEMA 5-15P	Ⓜ NEMA 5-15P
Full Load Amp.	2.4	2.4	2.5
Compressor HP	1/6	1/6	1/6
Cord Length (ft.)	9	9	10
Refrigerant	R-290	R-290	R-290
DIMENSIONAL DATA			
Net Capacity (cu. ft.)	17	17	18.8
Ext. Dimension (L x D x H) (in.)	60 ^{1/4} x 30 [*] x 34 ^{1/8} [†]	60 ^{1/4} x 30 [*] x 34 ^{1/8} [†]	72 ^{5/8} x 30 [*] x 34 ^{1/8} [‡]
# of Doors	1	-	-
# of Drawers	2	4	6
# of Shelves	1	-	-
Shelf Size (L x D) (in.)	27 x 17	-	-
Net Weight (lbs.)	261	272	320
Gross Weight (lbs.)	299	312	355

Design and specifications subject to change without notice. Most updated spec sheets are available at www.turboairinc.com.

Actual shipping weight may differ due to extra packing materials for product protection.

* Depth does not include 1" for rear spacers. † Height does not include 5" for caster height. ‡ Height does not include 4-1/2" for caster height.

■ **WARRANTY: 5 Year Parts and Labor Warranty, 7 Year Compressor Warranty**

WORKTOP FREEZERS NATURAL Refrigerant

Self-Cleaning Condenser Equipped Units

- **Self-Cleaning Condenser (Patented)**
 The accumulation of dust in the condenser can cause the failure or breakdown of refrigerators. Refrigerators run normally until they reach a certain level of accumulation. At some point, when they are over the limit, their performance drops quickly resulting in damage to, or disposal of the stored products inside. The Self-Cleaning Condenser device keeps the condenser clean and prevents system failure by automatically brushing daily.
- **Digital temperature control & monitor system**
 Keeps food products safe by maintaining constant temperatures. External digital display allows for easy monitoring.
- **Hydrocarbon refrigerants (R-290)**
 With innovative and eco-friendly technology, Turbo Air brings you hydrocarbon refrigerators designed to meet DOE's Energy Conservation Standards in 2017 and to use EPA's SNAP Program approved HC refrigerants. Hydrocarbon refrigerants do not deplete the ozone layer and have very low contribution to global warming (ODP-0, GWP-3).
- **Stainless steel cabinet construction**
 The Turbo Air Super Deluxe model boasts a stainless steel interior and exterior (galvanized steel back & bottom). It guarantees the utmost in cleanliness and long product life. The Super Deluxe adds a touch of style to the most refined setting.
- **Sturdy, clean stainless steel shelving**
 Shelves are the most important part of cleanliness as they come in direct contact with food. After a while, PVC coated wire shelves may peel, rust and lead to unsanitary conditions. The Turbo Air Super Deluxe series uniquely provides stainless steel shelving.
- **Ergonomically designed doors**
 Customers' fatigue fades away with easy grip handles and doors that open effortlessly. These features along with self-closing doors make this the ultimate choice in customer convenience. ABS sheet door liners resist water condensation with thermal efficiency.
- **Freezer holds -10°F ~ 0°F for the best in frozen food preservation**
- **Standard features**

 - Anti-corrosion coated evaporator
 - Self-contained system
 - 4" dia. swivel casters with locks on the front set
 - High-density polyurethane insulation
 - Door locks

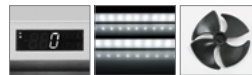
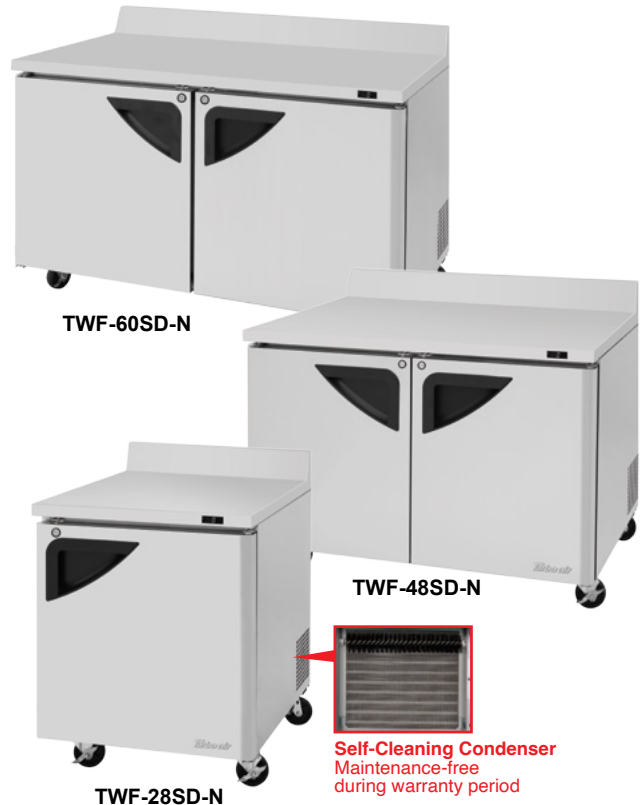

LED interior lighting & fan control

Energy efficient LED lighting lights every corner, making items easy to find. Fan control function automatically shuts off the fan when the door is open, which prevents hot air from being drawn in, thus maintaining the cool inner temperature.

■ **Optional features**

- Casters available for all models: 1", 2.5", 5"
- Legs available for all models: 6"
- Stainless steel single overshelf available (except TWF-28SD-N)

TWF MODELS SPECIFICATIONS

ELECTRICAL DATA	TWF-28SD-N	TWF-48SD-N	TWF-60SD-N
Voltage	115/60/1	115/60/1	115/60/1
Plug Type	Ⓢ NEMA 5-15P	Ⓢ NEMA 5-15P	Ⓢ NEMA 5-15P
Full Load Amp.	2.2	2.8	4.8
Compressor HP	1/4+	1/3	1/2
Cord Length (ft.)	9	9	9
Refrigerant	R-290	R-290	R-290
DIMENSIONAL DATA			
Net Capacity (cu. ft.)	6.8	12	17
Ext. Dimension (L x D x H†) (in.)	27 1/2 x 30 x 34 1/8	48 1/4 x 30 x 34 1/8	60 1/4 x 30 x 34 1/8
# of Doors	1	2	2
# of Shelves	1	2	2
Shelf Size (L x D) (in.)	22 1/2 x 17	21 x 17	27 x 17
Net Weight (lbs.)	157	235	254
Gross Weight (lbs.)	175	258	293

Design and specifications subject to change without notice. Most updated spec sheets are available at www.turboairinc.com.

Actual shipping weight may differ due to extra packing materials for product protection.

* Depth does not include 1" for rear spacers. † Height does not include 5" for caster height.

■ **WARRANTY: 5 Year Parts and Labor Warranty, 7 Year Compressor Warranty**

WORKTOP FREEZERS - DRAWERS NATURAL Refrigerant

Self-Cleaning Condenser Equipped Units

■ **Self-Cleaning Condenser (Patented)**

The accumulation of dust in the condenser can cause the failure or breakdown of refrigerators. Refrigerators run normally until they reach a certain level of accumulation. At some point, when they are over the limit, their performance drops quickly resulting in damage to, or disposal of the stored products inside. The Self-Cleaning Condenser device keeps the condenser clean and prevents system failure by automatically brushing daily.

■ **Digital temperature control & monitor system**

Keeps food products safe by maintaining constant temperatures. External digital display allows for easy monitoring.

■ **Hydrocarbon refrigerants (R-290)**

With innovative and eco-friendly technology, Turbo Air brings you hydrocarbon refrigerators designed to meet DOE's Energy Conservation Standards in 2017 and to use EPA's SNAP Program approved HC refrigerants. Hydrocarbon refrigerants do not deplete the ozone layer and have very low contribution to global warming (ODP-0, GWP-3).

■ **Stainless steel cabinet construction**

The Turbo Air Super Deluxe model boasts a stainless steel interior and exterior (galvanized steel back & bottom). It guarantees the utmost in cleanliness and long product life. The Super Deluxe adds a touch of style to the most refined setting.

■ **Sturdy, clean stainless steel shelving**

Shelves are the most important part of cleanliness as they come in direct contact with food. After a while, PVC coated wire shelves may peel, rust and lead to unsanitary conditions. The Super Deluxe series uniquely provides stainless steel shelving (only TWF-48SD-D2-N, TWF-60SD-D2R-N).

■ **Ergonomically designed doors**

Customers' fatigue fades away with easy grip handles and doors that open effortlessly. These features along with self-closing doors make this the ultimate choice in customer convenience. ABS sheet door liners resist water condensation with thermal efficiency (only TWF-48SD-D2-N, TWF-60SD-D2R-N).

■ **High-density polyurethane insulation**

The entire cabinet structure and solid doors are foamed-in-place using high density, CFC free polyurethane insulation.

■ **Freezer holds -10°F ~ 0°F for the best in frozen food preservation**

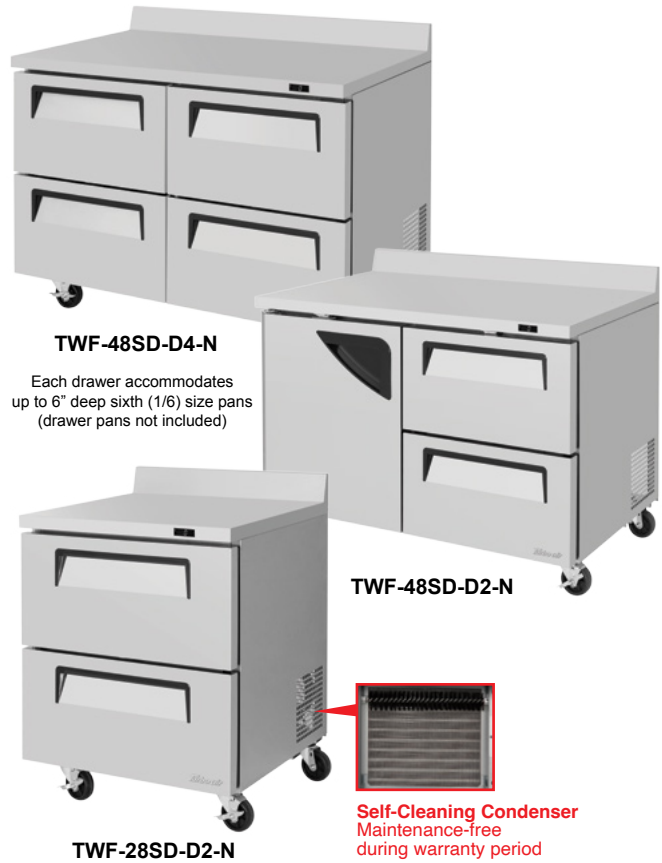

■ **Standard features**

- Anti-corrosion coated evaporator
- Self-contained system
- 4" dia. swivel casters with locks on the front set

■ **Optional features**

- Casters available for all models: 1", 2.5", 5"
- Legs available for all models: 6"
- Stainless steel single overshelf available (except TWF-28SD-D2-N)

TWF MODELS SPECIFICATIONS

ELECTRICAL DATA	TWF-28SD-D2-N	TWF-48SD-D2-N	TWF-48SD-D4-N	TWF-60SD-D2R-N
Voltage	115/60/1	115/60/1	115/60/1	115/60/1
Plug Type	Ⓜ NEMA 5-15P	Ⓜ NEMA 5-15P	Ⓜ NEMA 5-15P	Ⓜ NEMA 5-15P
Full Load Amp.	1.9	2.8	2.8	4.8
Compressor HP	1/4+	1/3	1/3	1/2
Cord Length (ft.)	9	9	9	10
Refrigerant	R-290	R-290	R-290	R-290
DIMENSIONAL DATA				
Net Capacity (cu. ft.)	7	12	12	17
Ext. Dimension (L x D x H) (in.)	27 ¹ / ₂ x 30* x 34 ¹ / ₈ †	48 ¹ / ₄ x 30* x 34 ¹ / ₈ †	48 ¹ / ₄ x 30* x 34 ¹ / ₈ †	60 ¹ / ₄ x 30* x 34 ¹ / ₄ ‡
# of Doors	-	1	-	1
# of Drawers	2	2	4	2
# of Shelves	-	1	-	1
Shelf Size (L x D) (in.)	-	21 x 17	-	27 x 17
Net Weight (lbs.)	163	241	249	256
Gross Weight (lbs.)	180	263	271	295

Design and specifications subject to change without notice. Most updated spec sheets are available at www.turboairinc.com.

Actual shipping weight may differ due to extra packing materials for product protection.

* Depth does not include 1" for rear spacers. † Height does not include 5" for caster height. ‡ Height does not include 4-1/2" for caster height.

■ **WARRANTY: 5 Year Parts and Labor Warranty, 7 Year Compressor Warranty**

WORKTOP REFRIGERATORS - FRONT BREATHING AIRFLOW

Self-Cleaning Condenser Equipped Units

■ **Self-Cleaning Condenser (Patented)**

The accumulation of dust in the condenser can cause the failure or breakdown of refrigerators. Refrigerators run normally until they reach a certain level of accumulation. At some point, when they are over the limit, their performance drops quickly resulting in damage to, or disposal of the stored products inside. The Self-Cleaning Condenser device keeps the condenser clean and prevents system failure by automatically brushing daily.

■ **Digital temperature control & monitor system**

Keeps food products safe by maintaining constant temperatures. External digital display allows for easy monitoring.

■ **Front Breathing airflow**

Front Breathing airflow is designed to draw in air and discharge from the front, allowing units to run at high efficiency in tight spaces and eliminates the need for surrounding clearances.

■ **Hydrocarbon refrigerants (R-290)**

With innovative and eco-friendly technology, Turbo Air brings you hydrocarbon refrigerators designed to meet DOE's Energy Conservation Standards in 2017 and to use EPA's SNAP Program approved HC refrigerants. Hydrocarbon refrigerants do not deplete the ozone layer and have very low contribution to global warming (ODP-0, GWP-3).

■ **Stainless steel cabinet construction**

The Turbo Air Super Deluxe model boasts a stainless steel interior and exterior (galvanized steel back & bottom). It guarantees the utmost in cleanliness and long product life. The Super Deluxe adds a touch of style to the most refined setting.

■ **Sturdy, clean stainless steel shelving**

Shelves are the most important part of cleanliness as they come in direct contact with food. After a while, PVC coated wire shelves may peel, rust and lead to unsanitary conditions. The Super Deluxe series uniquely provides stainless steel shelving.

■ **Ergonomically designed doors**

Customers' fatigue fades away with easy grip handles and doors that open effortlessly. These features along with self-closing doors make this the ultimate choice in customer convenience. ABS sheet door liners resist water condensation with thermal efficiency.

■ **Refrigerator holds 33°F ~ 38°F for the best in food preservation**

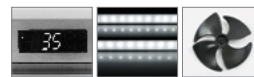

LED interior lighting & fan control

Energy efficient LED lighting lights every corner, making items easy to find. Fan control function automatically shuts off the fan when the door is open, which prevents hot air from being drawn in, thus maintaining the cool inner temperature.

■ **Standard features**

- Anti-corrosion coated evaporator
- Self-contained system
- 4" dia. swivel casters with locks on the front set
- Door locks

■ **Optional features**

- Casters available for all models: 1" / 2.5" (except TWR-28SD-FB-N), 5"
- Legs available for all models: 6"

TWR MODELS SPECIFICATIONS

ELECTRICAL DATA	TWR-28SD-FB-N	TWR-36SD-FB-N	TWR-48SD-FB-N	TWR-60SD-FB-N	TWR-72SD-FB-N
Voltage	115/60/1	115/60/1	115/60/1	115/60/1	115/60/1
Plug Type	Ⓢ NEMA 5-15P	Ⓢ NEMA 5-15P	Ⓢ NEMA 5-15P	Ⓢ NEMA 5-15P	Ⓢ NEMA 5-15P
Full Load Amp.	6.6	6.5	6.5	8.9	9.9
Compressor HP	1/5	1/5	1/5	1/5	1/5
Cord Length (ft.)	10	9	10	10	10
Refrigerant	R-290	R-290	R-290	R-290	R-290
DIMENSIONAL DATA					
Net Capacity (cu. ft.)	6.5	9	11.1	14.8	17.6
Ext. Dimension (L x D x H†) (in.)	27 1/2 x 30 x 34 1/8	36 1/4 x 30 x 34 1/4	48 1/4 x 30 x 34 1/8	60 1/4 x 30 x 34 1/8	72 5/8 x 30 x 34 1/8
# of Doors	1	2	2	2	3
# of Shelves	1	2	2	2	3
Shelf Size (L x D) (in.)	22 1/2 x 17	15 x 17	21 x 17	27 x 17	21 x 17 (L/R), 23 x 17 (M)
Net Weight (lbs.)	181	167	254	332	367
Gross Weight (lbs.)	206	187	284	363	407

Design and specifications subject to change without notice. Most updated spec sheets are available at www.turboairinc.com.

Actual shipping weight may differ due to extra packing materials for product protection.

† Height does not include 4-1/2" for caster height.

■ **WARRANTY: 5 Year Parts and Labor Warranty, 7 Year Compressor Warranty**

Self-Cleaning Condenser Equipped Units

■ **Self-Cleaning Condenser (Patented)**

The accumulation of dust in the condenser can cause the failure or breakdown of refrigerators. Refrigerators run normally until they reach a certain level of accumulation. At some point, when they are over the limit, their performance drops quickly resulting in damage to, or disposal of the stored products inside. The Self-Cleaning Condenser device keeps the condenser clean and prevents system failure by automatically brushing daily.

■ **Digital temperature control & monitor system**

Keeps food products safe by maintaining constant temperatures. External digital display allows for easy monitoring.

■ **Front Breathing airflow**

Front Breathing airflow is designed to draw in air and discharge from the front, allowing units to run at high efficiency in tight spaces and eliminates the need for surrounding clearances.

■ **Hydrocarbon refrigerants (R-290)**

With innovative and eco-friendly technology, Turbo Air brings you hydrocarbon refrigerators designed to meet DOE's Energy Conservation Standards in 2017 and to use EPA's SNAP Program approved HC refrigerants. Hydrocarbon refrigerants do not deplete the ozone layer and have very low contribution to global warming (ODP-0, GWP-3).

■ **Stainless steel cabinet construction**

The Turbo Air Super Deluxe model boasts a stainless steel interior and exterior (galvanized steel back & bottom). It guarantees the utmost in cleanliness and long product life. The Super Deluxe adds a touch of style to the most refined setting.

■ **Sturdy, clean stainless steel shelving**

Shelves are the most important part of cleanliness as they come in direct contact with food. After a while, PVC coated wire shelves may peel, rust and lead to unsanitary conditions. The Super Deluxe series uniquely provides stainless steel shelving (only TWR-48SD-D2R(L)-FB-N).

■ **Ergonomically designed doors**

Customers' fatigue fades away with easy grip handles and doors that open effortlessly. These features along with self-closing doors make this the ultimate choice in customer convenience. ABS sheet door liners resist water condensation with thermal efficiency (only TWR-48SD-D2R(L)-FB-N).

■ **High-density polyurethane insulation**

The entire cabinet structure and solid doors are foamed-in-place using high density, CFC free polyurethane insulation.



TWR-48SD-D2R-FB-N

Each drawer accommodates up to 6" deep sixth (1/6) size pans



TWR-28SD-D2-FB-N

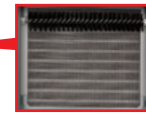

Self-Cleaning Condenser
Maintenance-free during warranty period

■ **Refrigerator holds 33°F ~ 38°F for the best in food preservation**

■ **Standard features**

- Anti-corrosion coated evaporator
- Self-contained system
- 4" dia. swivel casters with locks on the front set

■ **Optional features**

- Casters available for all models: 1" / 2.5" (except TWR-28SD-D2-FB-N), 5"
- Legs available for all models: 6"
- Stainless steel single overshelf available (except TWR-28SD-D2-FB-N)

TWR MODELS SPECIFICATIONS

ELECTRICAL DATA	TWR-28SD-D2-FB-N	TWR-48SD-D2R(L)-FB-N	TWR-48SD-D4-FB-N
Voltage	115/60/1	115/60/1	115/60/1
Plug Type	Ⓢ NEMA 5-15P	Ⓢ NEMA 5-15P	Ⓢ NEMA 5-15P
Full Load Amp.	6.6	6.5	6.5
Compressor HP	1/5	1/5	1/5
Cord Length (ft.)	10	10	10
Refrigerant	R-290	R-290	R-290
DIMENSIONAL DATA			
Net Capacity (cu. ft.)	6.5	11.1	11.1
Ext. Dimension (L x D x H†) (in.)	27 1/2 x 30 x 34 1/8	48 1/4 x 30 x 34 1/8	48 1/4 x 30 x 34 1/8
# of Doors	-	1	-
# of Drawers	2	2	4
# of Shelves	-	1	-
Shelf Size (L x D) (in.)	-	21 x 17	-
Net Weight (lbs.)	181	254	264
Gross Weight (lbs.)	206	284	294

Design and specifications subject to change without notice. Most updated spec sheets are available at www.turboairinc.com.

Actual shipping weight may differ due to extra packing materials for product protection.

† Height does not include 4-1/2" for caster height.

■ **WARRANTY: 5 Year Parts and Labor Warranty, 7 Year Compressor Warranty**

WORKTOP REF. - FRONT BREATHING AIRFLOW/DRAWERS



Self-Cleaning Condenser Equipped Units

■ **Self-Cleaning Condenser (Patented)**

The accumulation of dust in the condenser can cause the failure or breakdown of refrigerators. Refrigerators run normally until they reach a certain level of accumulation. At some point, when they are over the limit, their performance drops quickly resulting in damage to, or disposal of the stored products inside. The Self-Cleaning Condenser device keeps the condenser clean and prevents system failure by automatically brushing daily.

■ **Digital temperature control & monitor system**

Keeps food products safe by maintaining constant temperatures. External digital display allows for easy monitoring.

■ **Front Breathing airflow**

Front Breathing airflow is designed to draw in air and discharge from the front, allowing units to run at high efficiency in tight spaces and eliminates the need for surrounding clearances.

■ **Hydrocarbon refrigerants (R-290)**

With innovative and eco-friendly technology, Turbo Air brings you hydrocarbon refrigerators designed to meet DOE's Energy Conservation Standards in 2017 and to use EPA's SNAP Program approved HC refrigerants. Hydrocarbon refrigerants do not deplete the ozone layer and have very low contribution to global warming (ODP-0, GWP-3).

■ **Stainless steel cabinet construction**

The Turbo Air Super Deluxe model boasts a stainless steel interior and exterior (galvanized steel back & bottom). It guarantees the utmost in cleanliness and long product life. The Super Deluxe adds a touch of style to the most refined setting.

■ **Sturdy, clean stainless steel shelving**

Shelves are the most important part of cleanliness as they come in direct contact with food. After a while, PVC coated wire shelves may peel, rust and lead to unsanitary conditions. The Super Deluxe series uniquely provides stainless steel shelving (only TWR-60SD-D2R(L)-FB-N, TWR-72SD-D4R(L)-FB-N).

■ **Ergonomically designed doors**

Customers' fatigue fades away with easy grip handles and doors that open effortlessly. These features along with self-closing doors make this the ultimate choice in customer convenience. ABS sheet door liners resist water condensation with thermal efficiency (only TWR-60SD-D2R(L)-FB-N, TWR-72SD-D4R(L)-FB-N).

■ **High-density polyurethane insulation**

The entire cabinet structure and solid doors are foamed-in-place using high density, CFC free polyurethane insulation.

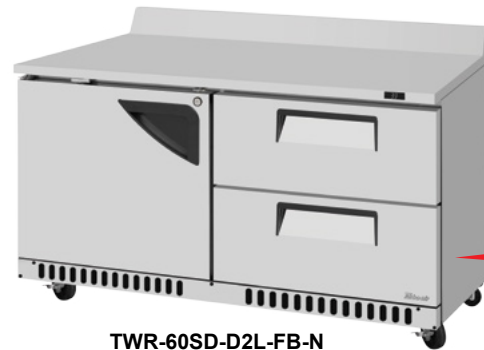

TWR-60SD-D2L-FB-N

Each drawer accommodates up to 6" deep sixth (1/6) size pans

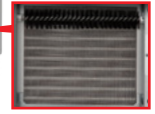

Self-Cleaning Condenser
Maintenance-free during warranty period

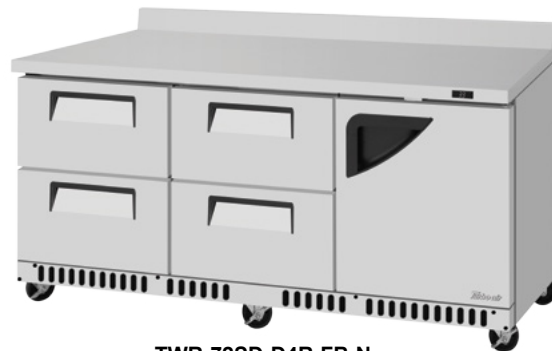

TWR-72SD-D4R-FB-N

■ **Refrigerator holds 33°F ~ 38°F for the best in food preservation**

■ **Standard features**

- Anti-corrosion coated evaporator
- Self-contained system
- 4" dia. swivel casters with locks on the front set

■ **Optional features**

- Casters available for all models: 1", 2.5", 5"
- Legs available for all models: 6"
- Stainless steel single overshelf available

TWR MODELS SPECIFICATIONS

ELECTRICAL DATA	TWR-60SD-D2R(L)-FB-N	TWR-60SD-D4-FB-N	TWR-72SD-D4R(L)-FB-N	TWR-72SD-D6-FB-N
Voltage	115/60/1	115/60/1	115/60/1	115/60/1
Plug Type	Ⓜ NEMA 5-15P	Ⓜ NEMA 5-15P	Ⓜ NEMA 5-15P	Ⓜ NEMA 5-15P
Full Load Amp.	8.9	8.9	9.9	9.9
Compressor HP	1/5	1/5	1/5	1/5
Cord Length (ft.)	10	10	10	10
Refrigerant	R-290	R-290	R-290	R-290
DIMENSIONAL DATA				
Net Capacity (cu. ft.)	14.8	14.8	17.6	17.6
Ext. Dimension (L x D x H†) (in.)	60 1/4 x 30 x 34 1/8	60 1/4 x 30 x 34 1/8	72 5/8 x 30 x 34 1/8	72 5/8 x 30 x 34 1/8
# of Doors	1	-	1	-
# of Drawers	2	4	4	6
# of Shelves	1	-	1	-
Shelf Size (L x D) (in.)	27 x 17	-	21 x 17	-
Net Weight (lbs.)	332	342	367	377
Gross Weight (lbs.)	363	373	407	417

Design and specifications subject to change without notice. Most updated spec sheets are available at www.turboairinc.com.

Actual shipping weight may differ due to extra packing materials for product protection.

† Height does not include 4-1/2" for caster height.

■ **WARRANTY: 5 Year Parts and Labor Warranty, 7 Year Compressor Warranty**

WORKTOP FREEZERS - FRONT BREATHING AIRFLOW NATURAL Refrigerant

Self-Cleaning Condenser Equipped Units

■ **Self-Cleaning Condenser (Patented)**

The accumulation of dust in the condenser can cause the failure or breakdown of refrigerators. Refrigerators run normally until they reach a certain level of accumulation. At some point, when they are over the limit, their performance drops quickly resulting in damage to, or disposal of the stored products inside. The Self-Cleaning Condenser device keeps the condenser clean and prevents system failure by automatically brushing daily.

■ **Digital temperature control & monitor system**

Keeps food products safe by maintaining constant temperatures. External digital display allows for easy monitoring.

■ **Front Breathing airflow**

Front Breathing airflow is designed to draw in air and discharge from the front, allowing units to run at high efficiency in tight spaces and eliminates the need for surrounding clearances.

■ **Hydrocarbon refrigerants (R-290)**

With innovative and eco-friendly technology, Turbo Air brings you hydrocarbon refrigerators designed to meet DOE's Energy Conservation Standards in 2017 and to use EPA's SNAP Program approved HC refrigerants. Hydrocarbon refrigerants do not deplete the ozone layer and have very low contribution to global warming (ODP-0, GWP-3).

■ **Stainless steel cabinet construction**

The Turbo Air Super Deluxe model boasts a stainless steel interior and exterior (galvanized steel back & bottom). It guarantees the utmost in cleanliness and long product life. The Super Deluxe adds a touch of style to the most refined setting.

■ **Sturdy, clean stainless steel shelving**

Shelves are the most important part of cleanliness as they come in direct contact with food. After a while, PVC coated wire shelves may peel, rust and lead to unsanitary conditions. The Super Deluxe series uniquely provides stainless steel shelving.

■ **Ergonomically designed doors**

Customers' fatigue fades away with easy grip handles and doors that open effortlessly. These features along with self-closing doors make this the ultimate choice in customer convenience. ABS sheet door liners resist water condensation with thermal efficiency.

■ **Freezer holds -10°F ~ 0°F for the best in food preservation**

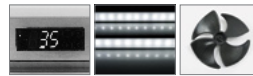
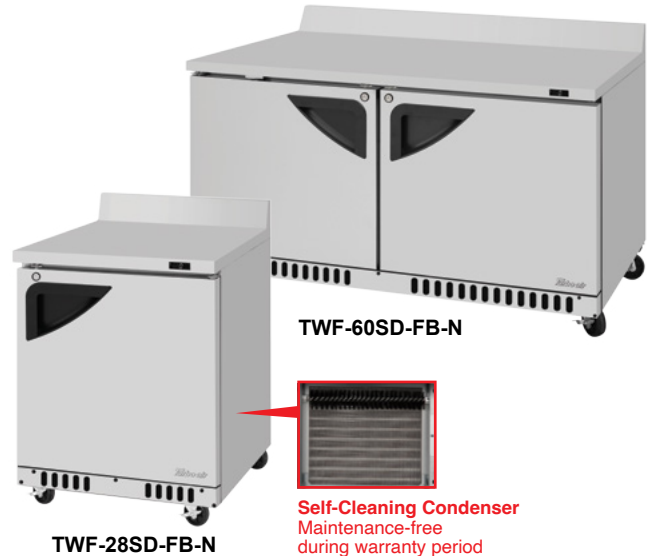

LED interior lighting & fan control (only at Turbo Air)

Energy efficient LED lighting lights every corner, making items easy to find. Fan control function automatically shuts off the fan when the door is open, which prevents hot air from being drawn in, thus maintaining the cool inner temperature.

■ **Standard features**

- Anti-corrosion coated evaporator
- Self-contained system
- 4" dia. swivel casters with locks on the front set
- High-density polyurethane insulation
- Magnetic door gaskets
- Door locks

■ **Optional features**

- Casters available for all models: 1" / 2.5" (except TWF-28SD-FB-N), 5"
- Legs available for all models: 6"
- Stainless steel single overshef available (except TWF-28SD-FB-N)

TWF MODELS SPECIFICATIONS

ELECTRICAL DATA	TWF-28SD-FB-N	TWF-48SD-FB-N	TWF-60SD-FB-N
Voltage	115/60/1	115/60/1	115/60/1
Plug Type	Ⓢ NEMA 5-15P	Ⓢ NEMA 5-15P	Ⓢ NEMA 5-15P
Full Load Amp.	4.5	8	8
Compressor HP	1/4	1/3	1/2
Cord Length (ft.)	10	10	10
Refrigerant	R-290	R-290	R-290
DIMENSIONAL DATA			
Net Capacity (cu. ft.)	6.5	14.8	17.6
Ext. Dimension (L x D x H†) (in.)	27 1/2 x 30 x 34 1/8	48 1/4 x 30 x 34 1/8	60 1/4 x 30 x 34 1/8
# of Doors	1	2	2
# of Shelves	1	2	2
Shelf Size (L x D) (in.)	22 1/2 x 17	21 x 17	27 x 17
Net Weight (lbs.)	181	254	332
Gross Weight (lbs.)	206	284	363

Design and specifications subject to change without notice. Most updated spec sheets are available at www.turboairinc.com.

Actual shipping weight may differ due to extra packing materials for product protection.

† Height does not include 4-1/2" for caster height.

■ **WARRANTY: 5 Year Parts and Labor Warranty, 7 Year Compressor Warranty**

WORKTOP FREEZERS - FRONT BREATHING AIRFLOW/DRAWERS

Self-Cleaning Condenser Equipped Units

■ **Self-Cleaning Condenser (Patented)**

The accumulation of dust in the condenser can cause the failure or breakdown of refrigerators. Refrigerators run normally until they reach a certain level of accumulation. At some point, when they are over the limit, their performance drops quickly resulting in damage to, or disposal of the stored products inside. The Self-Cleaning Condenser device keeps the condenser clean and prevents system failure by automatically brushing daily.

■ **Digital temperature control & monitor system**

Keeps food products safe by maintaining constant temperatures. External digital display allows for easy monitoring.

■ **Front Breathing airflow**

Front Breathing airflow is designed to draw in air and discharge from the front, allowing units to run at high efficiency in tight spaces and eliminates the need for surrounding clearances.

■ **Hydrocarbon refrigerants (R-290)**

With innovative and eco-friendly technology, Turbo Air brings you hydrocarbon refrigerators designed to meet DOE's Energy Conservation Standards in 2017 and to use EPA's SNAP Program approved HC refrigerants. Hydrocarbon refrigerants do not deplete the ozone layer and have very low contribution to global warming (ODP-0, GWP-3).

■ **Stainless steel cabinet construction**

The Turbo Air Super Deluxe model boasts a stainless steel interior and exterior (galvanized steel back & bottom). It guarantees the utmost in cleanliness and long product life. The Super Deluxe adds a touch of style to the most refined setting.

■ **Sturdy, clean stainless steel shelving**

Shelves are the most important part of cleanliness as they come in direct contact with food. After a while, PVC coated wire shelves may peel, rust and lead to unsanitary conditions. The Super Deluxe series uniquely provides stainless steel shelving (only TWF-48SD-D2R(L)-FB-N, TWF-60SD-D2R(L)-FB-N).

■ **Ergonomically designed doors**

Customers' fatigue fades away with easy grip handles and doors that open effortlessly. These features along with self-closing doors make this the ultimate choice in customer convenience. ABS sheet door liners resist water condensation with thermal efficiency (only TWF-48SD-D2R(L)-FB-N, TWF-60SD-D2R(L)-FB-N).

■ **High-density polyurethane insulation**

The entire cabinet structure and solid doors are foamed-in-place using high density, CFC free polyurethane insulation.



TWF-48SD-D2L-FB-N

Each drawer accommodates up to 6" deep sixth (1/6) size pans



TWF-28SD-D2-FB-N

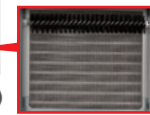

Self-Cleaning Condenser
Maintenance-free during warranty period

■ **Freezer holds -10°F ~ 0°F for the best in food preservation**

■ **Standard features**

- Anti-corrosion coated evaporator
- Self-contained system
- 4" dia. swivel casters with locks on the front set

■ **Optional features**

- Casters available for all models: 1" / 2.5" (except TWF-28SD-D2-FB-N), 5"
- Legs available for all models: 6"
- Stainless steel single overshef available (except TWF-28SD-D2-FB-N)

TWF MODELS SPECIFICATIONS

ELECTRICAL DATA	TWF-28SD-D2-FB-N	TWF-48SD-D2R(L)-FB-N	TWF-48SD-D4-FB-N	TWF-60SD-D2R(L)-FB-N	TWF-60SD-D4-FB-N
Voltage	115/60/1	115/60/1	115/60/1	115/60/1	115/60/1
Plug Type	Ⓢ NEMA 5-15P	Ⓢ NEMA 5-15P	Ⓢ NEMA 5-15P	Ⓢ NEMA 5-15P	Ⓢ NEMA 5-15P
Full Load Amp.	4.5	8	8	8	8
Compressor HP	1/4	1/3	1/3	1/2	1/2
Cord Length (ft.)	10	10	10	10	10
Refrigerant	R-290	R-290	R-290	R-290	R-290
DIMENSIONAL DATA					
Net Capacity (cu. ft.)	6.5	14.8	14.8	17.6	17.6
Ext. Dimension (L x D x H†) (in.)	27 1/2 x 30 x 34 1/8	48 1/4 x 30 x 34 1/8	48 1/4 x 30 x 34 1/8	60 1/4 x 30 x 34 1/8	60 1/4 x 30 x 34 1/8
# of Doors	-	1	-	1	-
# of Drawers	2	2	4	2	4
# of Shelves	-	1	-	1	-
Shelf Size (L x D) (in.)	-	21 x 17	-	27 x 17	-
Net Weight (lbs.)	181	254	264	332	342
Gross Weight (lbs.)	206	284	294	363	373

Design and specifications subject to change without notice. Most updated spec sheets are available at www.turboairinc.com.

Actual shipping weight may differ due to extra packing materials for product protection.

† Height does not include 4-1/2" for caster height.

■ **WARRANTY: 5 Year Parts and Labor Warranty, 7 Year Compressor Warranty**

WORKTOP REFRIGERATORS - SHALLOW DEPTH NATURAL Refrigerant

■ **Digital temperature control & monitor system**

Keeps food products safe by maintaining constant temperatures. External digital display allows for easy monitoring.

■ **Hydrocarbon refrigerants (R-600a)**

With innovative and eco-friendly technology, Turbo Air brings you hydrocarbon refrigerators designed to meet DOE's Energy Conservation Standards in 2017 and to use EPA's SNAP Program approved HC refrigerants. Hydrocarbon refrigerants do not deplete the ozone layer and have very low contribution to global warming (ODP-0, GWP-3).

■ **Stainless steel exterior**

The Turbo Air M3 model boasts a stainless steel exterior (galvanized steel back and bottom). Interior is stainless steel floor with AL sides and stainless steel back. It guarantees the utmost in cleanliness and long product life. The M3 model adds a touch of style to the most refined setting.

■ **High-density polyurethane insulation**

The entire cabinet structure and solid doors are foamed-in-place using high density, CFC free polyurethane insulation.

■ **Ergonomically designed doors**

Customers' fatigue fades away with easy grip handles and doors that open effortlessly. These features along with self-closing doors make this the ultimate choice in customer convenience. ABS sheet door liners resist water condensation with thermal efficiency.

■ **Adjustable, heavy duty, PE (polyethylene) coated wire shelves**

■ **Refrigerator holds 33°F ~ 38°F for the best in food preservation**

■ **Standard features**

- Anti-corrosion coated evaporator
- Self-contained system
- 4" dia. swivel casters with locks on the front set

■ **Optional features**

- Legs available for all models: 6"
- Casters available for all models: 2.5", 5"
- Door locks available (except MWR-34S-N6) - extra lead time will apply

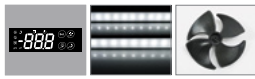

LED interior lighting & fan control

Energy efficient LED lighting lights every corner, making items easy to find. Fan control function automatically shuts off the fan when the door is open, which prevents hot air from being drawn in, thus maintaining the cool inner temperature.

MWR MODELS SPECIFICATIONS

ELECTRICAL DATA	MWR-20S-N6	MWR-24S-N6	MWR-27S-N6	MWR-34S-N6
Voltage	115/60/1	115/60/1	115/60/1	115/60/1
Plug Type	Ⓜ NEMA 5-15P	Ⓜ NEMA 5-15P	Ⓜ NEMA 5-15P	Ⓜ NEMA 5-15P
Full Load Amp.	2.3	2.4	2.4	2.6
Compressor HP	1/6	1/6	1/6	1/5
Cord Length (ft.)	9	9	9	9
Refrigerant	R-600a	R-600a	R-600a	R-600a
DIMENSIONAL DATA				
Net Capacity (cu. ft.)	2.29	2.86	3.28	4.27
Ext. Dimension (L x D x H) [†] (in.)	20 x 22 1/2 x 29 1/8	24 x 22 1/2 x 29 1/8	27 x 22 1/2 x 29 1/8	34 x 22 1/2 x 29 1/8
# of Doors	1	1	1	2
# of Shelves	1	1	1	2
Shelf Size (L x D) (in.)	15 3/8 x 11 1/8	19 3/8 x 11 1/8	22 3/8 x 11 1/8	14 1/4 x 11 1/8
Net Weight (lbs.)	117	126	135	150
Gross Weight (lbs.)	127	137	147	161

Design and specifications subject to change without notice. Most updated spec sheets are available at www.turboairinc.com.

Actual shipping weight may differ due to extra packing materials for product protection.

* Depth does not include 3/4" for rear spacers. † Height does not include 5" for caster height.

■ **WARRANTY: 5 Year Parts and Labor Warranty, 7 Year Compressor Warranty**

CHEF BASE REFRIGERATORS NATURAL Refrigerant

Self-Cleaning Condenser Equipped Units

- **Self-Cleaning Condenser (Patented)**
The accumulation of dust in the condenser can cause the failure or breakdown of refrigerators. Refrigerators run normally until they reach a certain level of accumulation. At some point, when they are over the limit, their performance drops quickly resulting in damage to, or disposal of the stored products inside. The Self-Cleaning Condenser device keeps the condenser clean and prevents system failure by automatically brushing daily.
- **Hydrocarbon refrigerants (R-290)**
With innovative and eco-friendly technology, Turbo Air brings you hydrocarbon refrigerators designed to meet DOE's Energy Conservation Standards in 2017 and to use EPA's SNAP Program approved HC refrigerants. Hydrocarbon refrigerants do not deplete the ozone layer and have very low contribution to global warming (ODP-0, GWP-3).
- **Digital temperature display on front panel**
- **Strong body and durable construction**
Built with heavy duty **16 ga.** stainless steel, Chef Base top is manufactured of one-piece reinforced stainless steel to ensure durability.
- **Countertops**
PRCBE-36/48/60R-N supports up to 788 pounds of equipment.
PRCBE-72/84/96R-N supports up to 1,192 pounds of equipment.
- **Durable stainless steel drawers**
- **Top is insulated to eliminate heat transfer to the interior of cabinet**
- **Side mount compressor unit**
With compressors positioned on the side of the unit, our refrigerators can now be serviced without being moved. Our front air intake feature also allows this model to be highly efficient in narrow spaces.
- **High-density polyurethane insulation**
The entire cabinet structure and solid doors are foamed-in-place using high density, CFC free polyurethane insulation.
- **Stainless steel top with drip guard (marine) edge**
- **Hot gas condensate system**
- **Full length drawer with gasket guard**
- **Drawer slider load capacity up to 180 lbs**

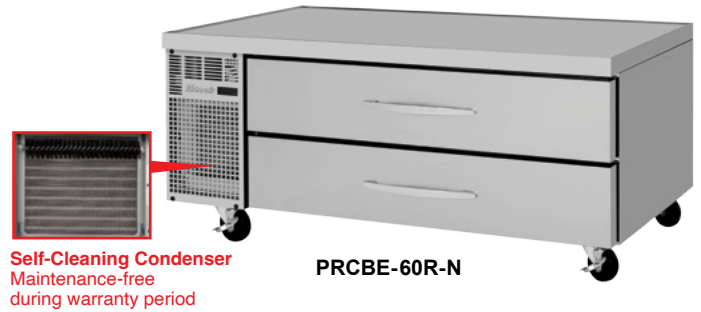

Each drawer accommodates up to 6" deep full size pans



- **4" Deep pans included**
- **Magnetic snap-in gasket**
- **Refrigerator holds 33°F ~ 38°F for the best in food preservation**
- **Standard features**
 - Anti-corrosion coated evaporator
 - Self-contained system
 - 4" dia. swivel casters
- **Optional features**
 - Legs available for all models: 6"
 - Casters available for all models: 5"

PRCBE MODELS SPECIFICATIONS

ELECTRICAL DATA	PRCBE-36R-N	PRCBE-48R-N	PRCBE-60R-N	PRCBE-72R-N	PRCBE-84R-N	PRCBE-96R-N
Voltage	115/60/1	115/60/1	115/60/1	115/60/1	115/60/1	115/60/1
Plug Type	Ⓜ NEMA 5-15P	Ⓜ NEMA 5-15P	Ⓜ NEMA 5-15P	Ⓜ NEMA 5-15P	Ⓜ NEMA 5-15P	Ⓜ NEMA 5-15P
Full Load Amp.	3.0	3.2	3.2	3.3	3.8	4.2
Compressor HP	1/4	1/4	1/4	1/4	3/8	3/8
Cord Length (ft.)	9	9	9	9	9	9
Refrigerant	R-290	R-290	R-290	R-290	R-290	R-290
DIMENSIONAL DATA						
Net Capacity (cu. ft.)	4.6	6.83	9.77	12.14	14.75	17.5
Ext. Dimension (L x D* x H†) (in.)	36 x 33 1/2 x 21 3/8	48 x 33 1/2 x 21 3/8	60 x 33 1/2 x 21 3/8	72 x 33 1/2 x 21 3/8	84 x 33 1/2 x 21 3/8	96 x 33 1/2 x 21 3/8
# of Drawers	2	2	2	4	4	4
Pan Capacity (# of pans)‡	Full size (2) 1/6 size (6)	Full size (4)	Full size (6)	Full size (6) 1/6 size (6)	Full size (8)	Full size (10)
Net Weight (lbs.)	248	277	317	407	461	551
Gross Weight (lbs.)	306	332	372	473	528	644

Design and specifications subject to change without notice. Most updated spec sheets are available at www.turboairinc.com.

Actual shipping weight may differ due to extra packing materials for product protection.

* Depth does not include 3/4" for drawer handles. † Height does not include 5" for caster height. ‡ Drawer pan not included.

■ **WARRANTY: 5 Year Parts and Labor Warranty, 7 Year Compressor Warranty**

CHEF BASE REFRIGERATORS - FLAT TOP NATURAL Refrigerant

Self-Cleaning Condenser Equipped Units

■ **Self-Cleaning Condenser (Patented)**

The accumulation of dust in the condenser can cause the failure or breakdown of refrigerators. Refrigerators run normally until they reach a certain level of accumulation. At some point, when they are over the limit, their performance drops quickly resulting in damage to, or disposal of the stored products inside. The Self-Cleaning Condenser device keeps the condenser clean and prevents system failure by automatically brushing daily.

■ **Hydrocarbon refrigerants (R-290)**

With innovative and eco-friendly technology, Turbo Air brings you hydrocarbon refrigerators designed to meet DOE's Energy Conservation Standards in 2017 and to use EPA's SNAP Program approved HC refrigerants. Hydrocarbon refrigerants do not deplete the ozone layer and have very low contribution to global warming (ODP-0, GWP-3).

■ **Digital temperature display on front panel**

■ **Strong body and durable construction**

Built with heavy duty 16 ga. stainless steel, Chef Base top is manufactured of one-piece reinforced stainless steel to ensure durability.

■ **Countertops**

PRCBE-36/48/60R-N-FT supports up to 788 pounds of equipment.
PRCBE-72/84/96R-N-FT supports up to 1,192 pounds of equipment.

■ **Durable stainless steel drawers**

■ **Top is insulated to eliminate heat transfer to the interior of cabinet**

■ **Side mount compressor unit**

With compressors positioned on the side of the unit, our refrigerators can now be serviced without being moved. Our front air intake feature also allows this model to be highly efficient in narrow spaces.

■ **High-density polyurethane insulation**

The entire cabinet structure and solid doors are foamed-in-place using high density, CFC free polyurethane insulation.

■ **Stainless steel flat top**

■ **Hot gas condensate system**

■ **Full length drawer with gasket guard**

■ **Drawer slider load capacity up to 180 lbs**

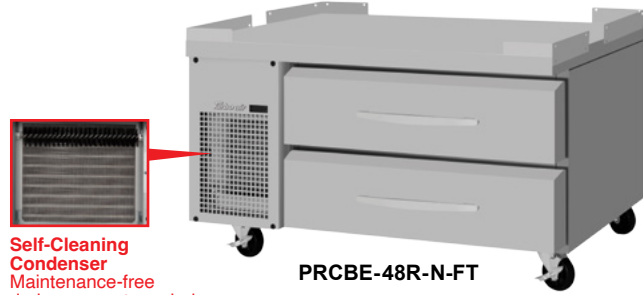

Self-Cleaning Condenser
Maintenance-free during warranty period

PRCBE-48R-N-FT

Each drawer accommodates up to 6" deep full size pans

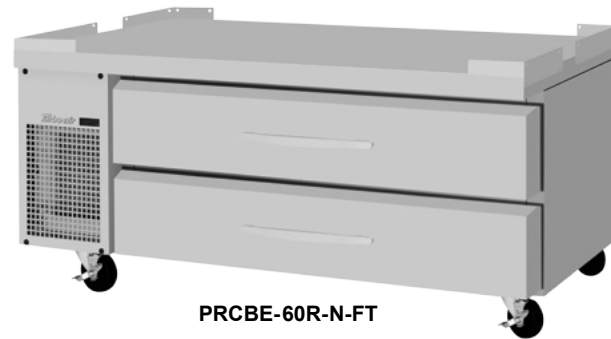

PRCBE-60R-N-FT

■ **4" Deep pans included**

■ **Magnetic snap-in gasket**

■ **Refrigerator holds 33°F ~ 38°F for the best in food preservation**

■ **Standard features**

- Anti-corrosion coated evaporator
- Self-contained system
- 4" dia. swivel casters

■ **Optional features**

- Legs available for all models: 6"
- Casters available for all models: 5"

PRCBE MODELS SPECIFICATIONS

ELECTRICAL DATA	PRCBE-36R-N-FT	PRCBE-48R-N-FT	PRCBE-60R-N-FT	PRCBE-72R-N-FT	PRCBE-84R-N-FT	PRCBE-96R-N-FT
Voltage	115/60/1	115/60/1	115/60/1	115/60/1	115/60/1	115/60/1
Plug Type	Ⓜ NEMA 5-15P	Ⓜ NEMA 5-15P	Ⓜ NEMA 5-15P	Ⓜ NEMA 5-15P	Ⓜ NEMA 5-15P	Ⓜ NEMA 5-15P
Full Load Amp.	3.0	3.2	3.2	3.3	3.8	4.2
Compressor HP	1/4	1/4	1/4	1/4	3/8	3/8
Cord Length (ft.)	9	9	9	9	9	9
Refrigerant	R-290	R-290	R-290	R-290	R-290	R-290
DIMENSIONAL DATA						
Net Capacity (cu. ft.)	4.6	6.83	9.77	12.14	14.75	17.5
Ext. Dimension (L x D* x H†) (in.)	36 x 33 1/2 x 21 3/8	48 x 33 1/2 x 21 3/8	60 x 33 1/2 x 21 3/8	72 x 33 1/2 x 21 3/8	84 x 33 1/2 x 21 3/8	96 x 33 1/2 x 21 3/8
# of Drawers	2	2	2	4	4	4
Pan Capacity (# of pans)‡	Full size (2) 1/6 size (6)	Full size (4)	Full size (6)	Full size (6) 1/6 size (6)	Full size (8)	Full size (10)
Net Weight (lbs.)	248	277	317	407	461	551
Gross Weight (lbs.)	306	332	372	473	528	644

Design and specifications subject to change without notice. Most updated spec sheets are available at www.turboairinc.com.

Actual shipping weight may differ due to extra packing materials for product protection.

* Depth does not include 3/4" for drawer handles. † Height does not include 5" for caster height. ‡ Drawer pan not included.

■ **WARRANTY: 5 Year Parts and Labor Warranty, 7 Year Compressor Warranty**

CHEF BASE FREEZERS NATURAL Refrigerant

Self-Cleaning Condenser Equipped Units

■ **Self-Cleaning Condenser (Patented)**

The accumulation of dust in the condenser can cause the failure or breakdown of refrigerators. Refrigerators run normally until they reach a certain level of accumulation. At some point, when they are over the limit, their performance drops quickly resulting in damage to, or disposal of the stored products inside. The Self-Cleaning Condenser device keeps the condenser clean and prevents system failure by automatically brushing daily.

■ **Hydrocarbon refrigerants (R-290)**

With innovative and eco-friendly technology, Turbo Air brings you hydrocarbon refrigerators designed to meet DOE's Energy Conservation Standards in 2017 and to use EPA's SNAP Program approved HC refrigerants. Hydrocarbon refrigerants do not deplete the ozone layer and have very low contribution to global warming (ODP-0, GWP-3).

■ **Digital temperature display on front panel**

■ **Strong body and durable construction**

Built with heavy duty 16 ga. stainless steel, Chef Base top is manufactured of one-piece reinforced stainless steel to ensure durability.

■ **Countertops**

PRCBE-36/48/60F-N supports up to 788 pounds of equipment. PRCBE-72/84/96F-N supports up to 1,192 pounds of equipment.

■ **Durable stainless steel drawers**

■ **Top is insulated to eliminate heat transfer to the interior of cabinet**

■ **Side mount compressor unit**

With compressors positioned on the side of the unit, our refrigerators can now be serviced without being moved. Our front air intake feature also allows this model to be highly efficient in narrow spaces.

■ **High-density polyurethane insulation**

The entire cabinet structure and solid doors are foamed-in-place using high density, CFC free polyurethane insulation.

■ **Stainless steel top with drip guard (marine) edge**

■ **Hot gas condensate system**

■ **Full length drawer with gasket guard**

■ **Drawer slider load capacity up to 180 lbs**



Each drawer accommodates up to 6" deep full size pans



■ **4" Deep pans included**

■ **Magnetic snap-in gasket**

■ **Freezer holds -10°F ~ 0°F for the best in frozen food preservation**

■ **Standard features**

- Anti-corrosion coated evaporator
- Self-contained system
- 4" dia. swivel casters

■ **Optional features**

- Legs available for all models: 6"
- Casters available for all models: 5"

PRCBE MODELS SPECIFICATIONS

ELECTRICAL DATA	PRCBE-36F-N	PRCBE-48F-N	PRCBE-60F-N	PRCBE-72F-N	PRCBE-84F-N	PRCBE-96F-N
Voltage	115/60/1	115/60/1	115/60/1	115/60/1	115/60/1	115/60/1
Plug Type	Ⓢ NEMA 5-15P	Ⓢ NEMA 5-15P	Ⓢ NEMA 5-15P	Ⓢ NEMA 5-15P	Ⓢ NEMA 5-15P	Ⓢ NEMA 5-15P
Full Load Amp.	5.5	5.9	6.4	9.5	9.7	9.7
Compressor HP	3/8	3/8	3/8	4/5	4/5	4/5
Cord Length (ft.)	9	9	9	9	9	9
Refrigerant	R-290	R-290	R-290	R-290	R-290	R-290
DIMENSIONAL DATA						
Net Capacity (cu. ft.)	4.6	6.83	9.77	12.14	14.75	17.5
Ext. Dimension (L x D [*] x H [†]) (in.)	36 x 33 1/2 x 21 3/8	48 x 33 1/2 x 21 3/8	60 x 33 1/2 x 21 3/8	72 x 33 1/2 x 21 3/8	84 x 33 1/2 x 21 3/8	96 x 33 1/2 x 21 3/8
# of Drawers	2	2	2	4	4	4
Pan Capacity (# of pans) [‡]	Full size (2) 1/6 size (6)	Full size (4)	Full size (6)	Full size (6) 1/6 size (6)	Full size (8)	Full size (10)
Net Weight (lbs.)	251	282	322	412	467	557
Gross Weight (lbs.)	311	337	377	478	533	650

Design and specifications subject to change without notice. Most updated spec sheets are available at www.turboairinc.com.

Actual shipping weight may differ due to extra packing materials for product protection.

* Depth does not include 3/4" for drawer handles. † Height does not include 5" for caster height. ‡ Drawer pan not included.

■ **WARRANTY: 5 Year Parts and Labor Warranty, 7 Year Compressor Warranty**

CHEF BASE FREEZERS - FLAT TOP NATURAL Refrigerant

Self-Cleaning Condenser Equipped Units

■ **Self-Cleaning Condenser (Patented)**

The accumulation of dust in the condenser can cause the failure or breakdown of refrigerators. Refrigerators run normally until they reach a certain level of accumulation. At some point, when they are over the limit, their performance drops quickly resulting in damage to, or disposal of the stored products inside. The Self-Cleaning Condenser device keeps the condenser clean and prevents system failure by automatically brushing daily.

■ **Hydrocarbon refrigerants (R-290)**

With innovative and eco-friendly technology, Turbo Air brings you hydrocarbon refrigerators designed to meet DOE's Energy Conservation Standards in 2017 and to use EPA's SNAP Program approved HC refrigerants. Hydrocarbon refrigerants do not deplete the ozone layer and have very low contribution to global warming (ODP-0, GWP-3).

■ **Digital temperature display on front panel**

■ **Strong body and durable construction**

Built with heavy duty 16 ga. stainless steel, Chef Base top is manufactured of one-piece reinforced stainless steel to ensure durability.

■ **Countertops**

PRCBE-36/48/60F-N-FT supports up to 788 pounds of equipment. PRCBE-72/84/96F-N-FT supports up to 1,192 pounds of equipment.

■ **Durable stainless steel drawers**

■ **Top is insulated to eliminate heat transfer to the interior of cabinet**

■ **Side mount compressor unit**

With compressors positioned on the side of the unit, our refrigerators can now be serviced without being moved. Our front air intake feature also allows this model to be highly efficient in narrow spaces.

■ **High-density polyurethane insulation**

The entire cabinet structure and solid doors are foamed-in-place using high density, CFC free polyurethane insulation.

■ **Stainless steel Flat top**

■ **Hot gas condensate system**

■ **Full length drawer with gasket guard**

■ **Drawer slider load capacity up to 180 lbs**

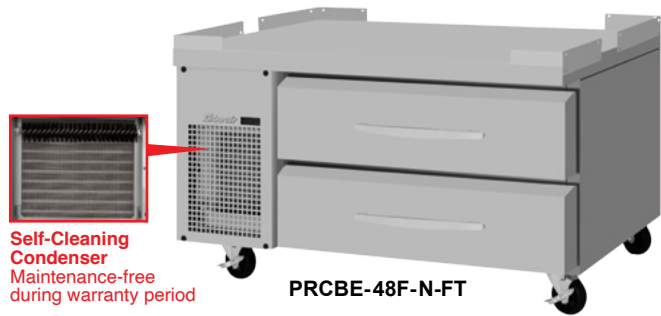
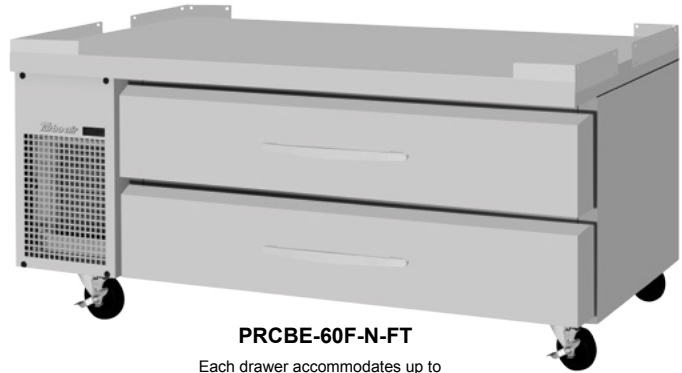

■ **4" Deep pans included**

■ **Magnetic snap-in gasket**

■ **Freezer holds -10°F ~ 0°F for the best in frozen food preservation**

■ **Standard features**

- Anti-corrosion coated evaporator
- Self-contained system
- 4" dia. swivel casters

■ **Optional features**

- Legs available for all models: 6"
- Casters available for all models: 5"

PRCBE MODELS SPECIFICATIONS

ELECTRICAL DATA	PRCBE-36F-N-FT	PRCBE-48F-N-FT	PRCBE-60F-N-FT	PRCBE-72F-N-FT	PRCBE-84F-N-FT	PRCBE-96F-N-FT
Voltage	115/60/1	115/60/1	115/60/1	115/60/1	115/60/1	115/60/1
Plug Type	Ⓜ NEMA 5-15P	Ⓜ NEMA 5-15P	Ⓜ NEMA 5-15P	Ⓜ NEMA 5-15P	Ⓜ NEMA 5-15P	Ⓜ NEMA 5-15P
Full Load Amp.	5.5	5.9	6.4	9.5	9.7	9.7
Compressor HP	3/8	3/8	3/8	4/5	4/5	4/5
Cord Length (ft.)	9	9	9	9	9	9
Refrigerant	R-290	R-290	R-290	R-290	R-290	R-290
DIMENSIONAL DATA						
Net Capacity (cu. ft.)	4.6	6.83	9.77	12.14	14.75	17.5
Ext. Dimension (L x D [†] x H [†]) (in.)	36 x 33 ¹ / ₂ x 21 ³ / ₈	48 x 33 ¹ / ₂ x 21 ³ / ₈	60 x 33 ¹ / ₂ x 21 ³ / ₈	72 x 33 ¹ / ₂ x 21 ³ / ₈	84 x 33 ¹ / ₂ x 21 ³ / ₈	96 x 33 ¹ / ₂ x 21 ³ / ₈
# of Drawers	2	2	2	4	4	4
Pan Capacity (# of pans) [‡]	Full size (2) 1/6 size (6)	Full size (4)	Full size (6)	Full size (6) 1/6 size (6)	Full size (8)	Full size (10)
Net Weight (lbs.)	251	282	322	412	467	557
Gross Weight (lbs.)	311	337	377	478	533	650

Design and specifications subject to change without notice. Most updated spec sheets are available at www.turboairinc.com.

Actual shipping weight may differ due to extra packing materials for product protection.

* Depth does not include 3/4" for drawer handles. † Height does not include 5" for caster height. ‡ Drawer pan not included.

■ **WARRANTY: 5 Year Parts and Labor Warranty, 7 Year Compressor Warranty**

CHEF BASE REFRIGERATORS NATURAL Refrigerant

Self-Cleaning Condenser Equipped Units

■ **Self-Cleaning Condenser (Patented)**

The accumulation of dust in the condenser can cause the failure or breakdown of refrigerators. Refrigerators run normally until they reach a certain level of accumulation. At some point, when they are over the limit, their performance drops quickly resulting in damage to, or disposal of the stored products inside. The Self-Cleaning Condenser device keeps the condenser clean and prevents system failure by automatically brushing daily.

■ **Hydrocarbon refrigerants (R-290 / R-600a)**

With innovative and eco-friendly technology, Turbo Air brings you hydrocarbon refrigerators designed to meet DOE's Energy Conservation Standards in 2017 and to use EPA's SNAP Program approved HC refrigerants. Hydrocarbon refrigerants do not deplete the ozone layer and have very low contribution to global warming (ODP-0, GWP-3).

■ **Digital temperature display on front panel**

■ **Strong body and durable construction**

Built with heavy duty 16 ga. stainless steel, Chef Base top is manufactured of one-piece reinforced stainless steel to ensure durability.

■ **Countertops**

TCBE-36SDR-N6/48/52SDR-N supports up to 788 pounds of equipment. TCBE-72/82SDR-N supports up to 1,192 pounds of equipment. TCBE-96SDR-N supports up to 1,435 pounds of equipment.

■ **Durable stainless steel drawers**

■ **Top is insulated to eliminate heat transfer to the interior of cabinet**

■ **Side mount compressor unit**

With compressors positioned on the side of the unit, our refrigerators can now be serviced without being moved. Our front air intake feature also allows this model to be highly efficient in narrow spaces.

■ **High-density polyurethane insulation**

The entire cabinet structure and solid doors are foamed-in-place using high density, CFC free polyurethane insulation.



TCBE-72SDR-N



TCBE-52SDR-N



TCBE-36SDR-N6

Each drawer accommodates up to 6" deep full size pans (drawer pans not included)

Self-Cleaning Condenser Maintenance-free during warranty period

■ **Refrigerator holds 33°F ~ 38°F for the best in food preservation**

■ **Standard features**

- Anti-corrosion coated evaporator
- Self-contained system
- 4" dia. swivel casters

■ **Optional features**

- Legs available for all models: 6"

TCBE MODELS SPECIFICATIONS

ELECTRICAL DATA	TCBE-36SDR-N6	TCBE-48SDR-N	TCBE-52SDR-N	TCBE-72SDR-N	TCBE-82SDR-N	TCBE-96SDR-N
Voltage	115/60/1	115/60/1	115/60/1	115/60/1	115/60/1	115/60/1
Plug Type	Ⓜ NEMA 5-15P	Ⓜ NEMA 5-15P	Ⓜ NEMA 5-15P	Ⓜ NEMA 5-15P	Ⓜ NEMA 5-15P	Ⓜ NEMA 5-15P
Full Load Amp.	2.8	3	5.1	5.6	6.2	6.3
Compressor HP	1/5	1/4	1/4+	1/4+	1/3	2/5
Cord Length (ft.)	9	9	9	9	9	9
Refrigerant	R-600a	R-290	R-290	R-290	R-290	R-290
DIMENSIONAL DATA						
Net Capacity (cu. ft.)	4.98	7.52	9.1	12.66	16.04	18.6
Ext. Dimension (L x D [*] x H [†]) (in.)	35 ⁵ / ₈ x 32 x 20 ¹ / ₄	47 ⁵ / ₈ x 32 x 20 ¹ / ₄	52 ¹ / ₄ x 32 x 20 ¹ / ₄	72 x 32 x 20 ¹ / ₄	83 ⁵ / ₈ x 32 x 20 ¹ / ₄	96 ³ / ₈ x 32 x 20 ¹ / ₄
# of Drawers	2	2	2	4	4	4
Pan Capacity (# of pans) [‡]	Full size (2) 1/6 size (6)	Full size (4) 1/6 size (6)	Full size (6)	Full size (8)	Full size (10)	Full size (12)
Net Weight (lbs.)	163	218	241	352	412	484
Gross Weight (lbs.)	229	284	307	418	469	517

Design and specifications subject to change without notice. Most updated spec sheets are available at www.turboairinc.com.

Actual shipping weight may differ due to extra packing materials for product protection.

* Depth does not include 1" for rear spacers. † Height does not include 5" for caster height. ‡ Drawer pan not included.

■ **WARRANTY: 5 Year Parts and Labor Warranty, 7 Year Compressor Warranty**

CHEF BASE REFRIGERATORS - EXTENDED TOP NATURAL Refrigerant

Self-Cleaning Condenser Equipped Units

■ **Self-Cleaning Condenser (Patented)**

The accumulation of dust in the condenser can cause the failure or breakdown of refrigerators. Refrigerators run normally until they reach a certain level of accumulation. At some point, when they are over the limit, their performance drops quickly resulting in damage to, or disposal of the stored products inside. The Self-Cleaning Condenser device keeps the condenser clean and prevents system failure by automatically brushing daily.

■ **Hydrocarbon refrigerants (R-290 / R-600a)**

With innovative and eco-friendly technology, Turbo Air brings you hydrocarbon refrigerators designed to meet DOE's Energy Conservation Standards in 2017 and to use EPA's SNAP Program approved HC refrigerants. Hydrocarbon refrigerants do not deplete the ozone layer and have very low contribution to global warming (ODP-0, GWP-3).

■ **Digital temperature display on front panel**

■ **Strong body and durable construction**

Built with heavy duty 16 ga. stainless steel Chef Base top is manufactured of one-piece reinforced stainless steel to ensure durability.

■ **Countertops**

TCBE-36SDR-N6/48/52SDR-E-N supports up to 788 pounds of equipment. TCBE-72/82SDR-E-N supports up to 1,192 pounds of equipment.

■ **Durable stainless steel drawers**

■ **Top is insulated to eliminate heat transfer to the interior of cabinet**

■ **Side mount compressor unit**

With compressors positioned on the side of the unit, our refrigerators can now be serviced without being moved. Our front air intake feature also allows this model to be highly efficient in narrow spaces.

■ **High-density polyurethane insulation**

The entire cabinet structure and solid doors are foamed-in-place using high density, CFC free polyurethane insulation.

■ **Refrigerator holds 33°F ~ 38°F for the best in food preservation**



TCBE-82SDR-E-N



TCBE-72SDR-E-N

Each drawer accommodates up to 6" deep full size pans (drawer pans not included)



TCBE-48SDR-E-N

Self-Cleaning Condenser
Maintenance-free
during warranty period

■ **Standard features**

- Anti-corrosion coated evaporator
- Self-contained system
- 4" dia. swivel casters

■ **Optional features**

- Legs available for all models: 6"

TCBE MODELS SPECIFICATIONS

ELECTRICAL DATA	TCBE-36SDR-E-N6	TCBE-48SDR-E-N	TCBE-52SDR-E-N	TCBE-72SDR-E-N	TCBE-82SDR-E-N
Voltage	115/60/1	115/60/1	115/60/1	115/60/1	115/60/1
Plug Type	Ⓜ NEMA 5-15P	Ⓜ NEMA 5-15P	Ⓜ NEMA 5-15P	Ⓜ NEMA 5-15P	Ⓜ NEMA 5-15P
Full Load Amp.	2.8	3	5.1	5.6	6.2
Compressor HP	1/5	1/4	1/4+	1/4+	1/3
Cord Length (ft.)	9	9	9	9	9
Refrigerant	R-600a	R-290	R-290	R-290	R-290
DIMENSIONAL DATA					
Net Capacity (cu. ft.)	4.98	7.52	9.1	12.66	16.04
Ext. Dimension (L x D [*] x H [†]) (in.)	41 ⁵ / ₈ x 32 x 20 ¹ / ₄	53 ⁵ / ₈ x 32 x 20 ¹ / ₄	58 ¹ / ₄ x 32 x 20 ¹ / ₄	78 x 32 x 20 ¹ / ₄	89 ¹ / ₂ x 32 x 20 ¹ / ₄
# of Drawers	2	2	2	4	4
Pan Capacity (# of pans) [‡]	Full size (2) 1/6 size (6)	Full size (4) 1/6 size (6)	Full size (6)	Full size (8)	Full size (10)
Net Weight (lbs.)	185	240	263	374	432
Gross Weight (lbs.)	251	306	329	440	498

Design and specifications subject to change without notice. Most updated spec sheets are available at www.turboairinc.com.

Actual shipping weight may differ due to extra packing materials for product protection.

* Depth does not include 1" for rear spacers. † Height does not include 5" for caster height. ‡ Drawer pan not included.

■ **WARRANTY: 5 Year Parts and Labor Warranty, 7 Year Compressor Warranty**



Glass Door Merchandisers

Super Deluxe Series

Swing Door Refrigerators / Freezers

Super Deluxe Jumbo Series

Swing Door Refrigerators / Freezers

Ice Merchandisers

Standard Series

Swing Door Refrigerators

Sliding Door Refrigerators

Swing Door Freezers

Ice Merchandisers

Top Open Island Freezers

Ice Cream Dipping Cabinets

GLASS DOOR MERCHANDISERS NATURAL Refrigerant

Self-Cleaning Condenser Equipped Units

Self-Cleaning Condenser (Patented)

The accumulation of dust in the condenser can cause the failure or breakdown of refrigerators. Refrigerators run normally until they reach a certain level of accumulation. At some point, when they are over the limit, their performance drops quickly resulting in damage to, or disposal of the stored products inside. The Self-Cleaning Condenser device keeps the condenser clean and prevents system failure by automatically brushing daily (except TGM-5SD/7SD-N6).

Digital temperature control & monitor system (except TGM-5SD-N6, TGM-7SD-N6)

- Keeps food products safe by maintaining constant temperatures
- Alarms that sound when doors are not sealed shut; protects against food spoilage that originates from cold air leaks
- Early Warning Alarm program detects issues before malfunction occurs
- Digital display allows for easy monitoring
- Programs interpret the condition of refrigeration systems by self-diagnosis
- Rapid cool-down function (Turbo Cooling)
- Automatic evaporator fan motor delays

Hydrocarbon refrigerants (R-600a)

With innovative and eco-friendly technology, Turbo Air brings you hydrocarbon refrigerators designed to meet DOE's Energy Conservation Standards in 2017 and to use EPA's SNAP Program approved HC refrigerants. Hydrocarbon refrigerants do not deplete the ozone layer and have very low contribution to global warming (ODP-0, GWP-3).

Energy conserving fan control

Utilizing algorithmic air circulation for optimal temperature levels, our innovative fan control system conserves energy by at least 15% and increases compressor life by up to 30% (except TGM-5SD/7SD-N6).

Double pane glass doors with Low-E glass

Energy saving double pane glass doors are equipped with Low-emissivity glass, which reduces outer heat gain and decreases energy consumption. It enhances energy efficiency and minimizes condensation. Lightweight door construction also reduces door maintenance and bushing wear, which in turn facilitates smoother door opening.

High-density polyurethane insulation

The entire cabinet structure is foamed-in-place using high density, HCFC free polyurethane insulation.

LED interior lighting



Self-Cleaning Condenser
Maintenance-free during warranty period

TGM-12SDW-N6

TGM-10SDB-N6

Refrigerator holds 33°F ~ 38°F for the best in food preservation

Standard features

- Anti-corrosion coated evaporator
- Door locks
- ‡ Two color options available: Super Deluxe series comes in white cabinet (W) and black cabinet with black color trim (B).

Optional features

- 4" dia. casters available -1/2" dia. & 13 TPI (except TGM-5SD/7SD-N6)
- Price tag channel available

TGM SUPER DELUXE MODELS SPECIFICATIONS

ELECTRICAL DATA	TGM-5SD*-N6	TGM-7SD*-N6	TGM-10SD*-N6	TGM-12SD*-N6
Voltage	115/60/1	115/60/1	115/60/1	115/60/1
Plug Type	Ⓢ NEMA 5-15P	Ⓢ NEMA 5-15P	Ⓢ NEMA 5-15P	Ⓢ NEMA 5-15P
Full Load Amp.	1.4	1.4	1.9	1.9
Compressor HP	1/10	1/10	1/10	1/10
Cord Length (ft.)	9	9	7	7
Refrigerant	R-600a	R-600a	R-600a	R-600a
DIMENSIONAL DATA				
Net Capacity (cu. ft.)	4.45	6.2	8.12	10.19
Bottle Capacity (12oz.)	80	136	236	236 (295 w/add. shelf)
Ext. Dimension (L x D x H) (in.)	25 x 23 1/4* x 30 1/2‡	25 x 23 1/4* x 38 1/8‡	25 3/4 x 23 1/4** x 54 3/8§	25 3/4 x 23 1/4** x 63§
# of Doors	1	1	1	1
# of Shelves	2	3	3	3
Shelf Size (L x D) (in.)	19 3/8 x 16 5/8	19 3/8 x 16 5/8	20 x 15 1/2	20 x 15 1/2
Net Weight (lbs.)	152	171	220	235
Gross Weight (lbs.)	183	202	241	257

Design and specifications subject to change without notice. Most updated spec sheets are available at www.turboairinc.com.

Actual shipping weight may differ due to extra packing materials for product protection.

* Depth does not include 2-3/8" for rear mechanical component, 1-5/8" for power cord bushing plus radius of curvature and 2-1/4" for door handle.

** Depth does not include 2-1/4" for door handle. ‡ Height does not include 2-1/4" for cabinet reinforcement. § Height does not include 1-5/8" cabinet reinforcement.

WARRANTY: 5 Year Parts and Labor Warranty, 7 Year Compressor Warranty

GLASS DOOR MERCHANDISERS NATURAL Refrigerant

Self-Cleaning Condenser Equipped Units

■ **Self-Cleaning Condenser (Patented)**

The accumulation of dust in the condenser can cause the failure or breakdown of refrigerators. Refrigerators run normally until they reach a certain level of accumulation. At some point, when they are over the limit, their performance drops quickly resulting in damage to, or disposal of the stored products inside. The Self-Cleaning Condenser device keeps the condenser clean and prevents system failure by automatically brushing daily.

■ **Digital temperature control & monitor system**

- Keeps food products safe by maintaining constant temperatures
- Alarms that sound when doors are not sealed shut; protects against food spoilage that originates from cold air leaks
- Early Warning Alarm program detects issues before malfunction occurs
- Digital display allows for easy monitoring
- Programs interpret the condition of refrigeration systems by self-diagnosis
- Rapid cool-down function (Turbo Cooling)
- Automatic evaporator fan motor delays

■ **Hydrocarbon refrigerants (R-600a)**

With innovative and eco-friendly technology, Turbo Air brings you hydrocarbon refrigerators designed to meet DOE's Energy Conservation Standards in 2017 and to use EPA's SNAP Program approved HC refrigerants. Hydrocarbon refrigerants do not deplete the ozone layer and have very low contribution to global warming (ODP-0, GWP-3).

■ **Energy conserving fan control**

Utilizing algorithmic air circulation for optimal temperature levels, our innovative fan control system conserves energy by at least 15% and increases compressor life by up to 30%.

■ **Double pane glass doors with Low-E glass**

Energy saving double pane glass doors are equipped with Low-emissivity glass, which reduces outer heat gain and decreases energy consumption. It enhances energy efficiency and minimizes condensation. Lightweight door construction also reduces door maintenance and bushing wear, which in turn facilitates smoother door opening.

■ **High-density polyurethane insulation**

The entire cabinet structure is foamed-in-place using high density, HCFC free polyurethane insulation.

■ **Shadow free advertising panel**

Turbo Air is a pioneer in the refrigerator industry on applying special LED Light Guided Panels (LGP). LGP increases panel visibility and eliminates shadows, enhancing any store atmosphere with eye-catching effects. LED lighting offers 5 times longer lasting life than fluorescents and conserves energy.



Self-Cleaning Condenser
Maintenance-free
during warranty period

TGM-20SDB-N6



TGM-23SDW-N6

■ **LED interior lighting**

■ **Refrigerator holds 33°F ~ 38°F for the best in food preservation**

■ **Standard features**

- Anti-corrosion coated evaporator
- Door locks
- ‡ Two color options available: Super Deluxe series comes in white cabinet (W) and black cabinet with black color trim (B).

■ **Optional features**

- 4" dia. casters available -1/2" dia. & 13 TPI
- Price tag channel available

TGM SUPER DELUXE MODELS SPECIFICATIONS

ELECTRICAL DATA	TGM-15SD*-N6	TGM-20SD*-N6	TGM-23SD*-N6
Voltage	115/60/1	115/60/1	115/60/1
Plug Type	Ⓢ NEMA 5-15P	Ⓢ NEMA 5-15P	Ⓢ NEMA 5-15P
Full Load Amp.	2.1	2.4	2.7
Compressor HP	1/5	1/5	1/5
Cord Length (ft.)	7	7	7
Refrigerant	R-600a	R-600a	R-600a
DIMENSIONAL DATA			
Net Capacity (cu. ft.)	14.43	16.01	19.4
Bottle Capacity (12oz.)	315 (378 w/add. shelf)	355 (426 w/add. shelf)	405 (486 w/add. shelf)
Ext. Dimension (L x D x H) (in.)	26 ^{3/8} x 24 ^{3/4} * x 75 ^{5/8} †	27 x 26 ^{3/8} * x 77 ‡	27 x 30 ^{1/4} * x 77‡
# of Doors	1	1	1
# of Shelves	4	4	4
Shelf Size (L x D) (in.)	20 ^{5/8} x 16 ^{3/8}	21 ^{1/2} x 17 ^{1/2}	21 ^{1/2} x 22 ^{1/2}
Net Weight (lbs.)	258	269	304
Gross Weight (lbs.)	281	292	325

Design and specifications subject to change without notice. Most updated spec sheets are available at www.turboairinc.com.

Actual shipping weight may differ due to extra packing materials for product protection.

* Depth does not include 2-1/4" for door handle. † Height does not include 1-5/8" for cabinet reinforcement. ‡ Height does not include 2-1/2" for cabinet reinforcement.

■ **WARRANTY: 5 Year Parts and Labor Warranty, 7 Year Compressor Warranty**

GLASS DOOR MERCHANDISERS NATURAL Refrigerant

Self-Cleaning Condenser Equipped Units

■ **Self-Cleaning Condenser (Patented)**

The accumulation of dust in the condenser can cause the failure or breakdown of refrigerators. Refrigerators run normally until they reach a certain level of accumulation. At some point, when they are over the limit, their performance drops quickly resulting in damage to, or disposal of the stored products inside. The Self-Cleaning Condenser device keeps the condenser clean and prevents system failure by automatically brushing daily.

■ **Digital temperature control & monitor system**

- Keeps food products safe by maintaining constant temperatures
- Alarms that sound when doors are not sealed shut; protects against food spoilage that originates from cold air leaks
- Early Warning Alarm program detects issues before malfunction occurs
- Digital display allows for easy monitoring
- Programs interpret the condition of refrigeration systems by self-diagnosis
- Rapid cool-down function (Turbo Cooling)
- Automatic evaporator fan motor delays

■ **Hydrocarbon refrigerants (R-290)**

With innovative and eco-friendly technology, Turbo Air brings you hydrocarbon refrigerators designed to meet DOE's Energy Conservation Standards in 2017 and to use EPA's SNAP Program approved HC refrigerants. Hydrocarbon refrigerants do not deplete the ozone layer and have very low contribution to global warming (ODP-0, GWP-3).

■ **Hot gas condensate system**

Through Turbo Air's creative innovation, the condensate system surfaces have been specially treated to resist corrosion. This not only increases efficiency without the risk of refrigerant leakage from corrosion, but also prevents the overflow of condensate water.

■ **Energy conserving fan control**

Utilizing algorithmic air circulation for optimal temperature levels, our innovative fan control system conserves energy by at least 15% and increases compressor life by up to 30%.

■ **Double pane glass doors with Low-E glass**

Energy saving double pane glass doors are equipped with Low-emissivity glass, which reduces outer heat gain and decreases energy consumption. It enhances energy efficiency and minimizes condensation. Lightweight door construction also reduces door maintenance and bushing wear, which in turn facilitates smoother door opening.

■ **Shadow free advertising panel**

Turbo Air is a pioneer in the refrigerator industry on applying special LED Light Guided Panels (LGP). LGP increases panel visibility and eliminates shadows, enhancing any store atmosphere with eye-catching effects. LED lighting offers 5 times longer lasting life than fluorescents and conserves energy.



Self-Cleaning Condenser
Maintenance-free
during warranty period

TGM-72SDW-N

TGM-47SDB-N

■ **High-density polyurethane insulation**

The entire cabinet structure is foamed-in-place using high density, HCFC free polyurethane insulation.

■ **LED interior lighting**

■ **Refrigerator holds 33°F ~ 38°F for the best in food preservation**

■ **Standard features**

- Anti-corrosion coated evaporator
- Door locks
- ‡ Two color options available: Super Deluxe series comes in white cabinet (W) and black cabinet with black color trim (B).

■ **Optional features**

- 4" dia. casters available - 1/2" dia. & 13 TPI
- Price tag channel available

TGM SUPER DELUXE MODELS SPECIFICATIONS

ELECTRICAL DATA	TGM-35SD±-N	TGM-47SD±-N	TGM-72SD±-N
Voltage	115/60/1	115/60/1	115/60/1
Plug Type	Ⓜ NEMA 5-15P	Ⓜ NEMA 5-15P	Ⓜ NEMA 5-15P
Full Load Amp.	3.3	3.4	7.9
Compressor HP	1/3	1/3	2/5
Cord Length (ft.)	7	7	7
Refrigerant	R-290	R-290	R-290
DIMENSIONAL DATA			
Net Capacity (cu. ft.)	29.06	41.71	67.98
Bottle Capacity (12oz.)	690 (828 w/add. shelf)	900 (1,080 w/add. shelf)	1,475 (1,770 w/add. shelf)
Ext. Dimension (L x D x H) (in.)	39 1/2 x 31 7/8* x 77 †	51 1/8 x 31 7/8* x 77 †	78 x 31 7/8* x 77 †
# of Doors	2	2	3
# of Shelves	8	8	12
Shelf Size (L x D) (in.)	17 x 22 1/2	22 1/2 x 23	22 3/4 x 23 3/4 (L/R), 24 3/4 x 23 3/4 (M)
Net Weight (lbs.)	385	432	634
Gross Weight (lbs.)	450	510	732

Design and specifications subject to change without notice. Most updated spec sheets are available at www.turboairinc.com.

Actual shipping weight may differ due to extra packing materials for product protection.

* Depth does not include 2-1/4" for door handles. † Height does not include 2-1/2" for cabinet reinforcement.

■ **WARRANTY: 5 Year Parts and Labor Warranty, 7 Year Compressor Warranty**

FULL VIEW GLASS DOOR MERCHANDISERS



Self-Cleaning Condenser Equipped Units

■ **Self-Cleaning Condenser (Patented)**

The accumulation of dust in the condenser can cause the failure or breakdown of refrigerators. Refrigerators run normally until they reach a certain level of accumulation. At some point, when they are over the limit, their performance drops quickly resulting in damage to, or disposal of the stored products inside. The Self-Cleaning Condenser device keeps the condenser clean and prevents system failure by automatically brushing daily.

■ **Digital temperature control & monitor system**

- Keeps food products safe by maintaining constant temperatures
- Alarms that sound when doors are not sealed shut; protects against food spoilage that originates from cold air leaks
- Early Warning Alarm program detects issues before malfunction occurs
- Digital display allows for easy monitoring
- Programs interpret the condition of refrigeration systems by self-diagnosis
- Rapid cool-down function (Turbo Cooling)
- Automatic evaporator fan motor delays

■ **Hydrocarbon refrigerants (R-600a / R-290)**

With innovative and eco-friendly technology, Turbo Air brings you hydrocarbon refrigerators designed to meet DOE's Energy Conservation Standards in 2017 and to use EPA's SNAP Program approved HC refrigerants. Hydrocarbon refrigerants do not deplete the ozone layer and have very low contribution to global warming (ODP-0, GWP-3).

■ **Hot gas condensate system**

Through Turbo Air's creative innovation, the condensate system surfaces have been specially treated to resist corrosion. This not only increases efficiency without the risk of refrigerant leakage from corrosion, but also prevents the overflow of condensate water (except TGM-15SDH/23SDH-N6).

■ **Energy conserving fan control**

Utilizing algorithmic air circulation for optimal temperature levels, our innovative fan control system conserves energy by at least 15% and increases compressor life by up to 30%.

■ **Double pane glass doors with Low-E glass**

Energy saving double pane glass doors are equipped with Low-emissivity glass, which reduces outer heat gain and decreases energy consumption. It enhances energy efficiency and minimizes condensation. Lightweight door construction also reduces door maintenance and bushing wear, which in turn facilitates smoother door opening.

■ **High-density polyurethane insulation**

The entire cabinet structure is foamed-in-place using high density, HCFC free polyurethane insulation.



Self-Cleaning Condenser Maintenance-free during warranty period

TGM-72SDHW-N

TGM-47SDHB-N

■ **LED interior lighting**

■ **Refrigerator holds 33°F ~ 38°F for the best in food preservation**

■ **Standard features**

- Anti-corrosion coated evaporator
- Door locks
- ‡ Two color options available: Super Deluxe series comes in white cabinet (W) or black cabinet with black color trim (B).

■ **Optional features**

- 4" dia. casters available -1/2" dia. & 13 TPI
- Price tag channel available

TGM SUPER DELUXE MODELS SPECIFICATIONS

ELECTRICAL DATA	TGM-15SDH:-N6	TGM-23SDH:-N6	TGM-35SDH:-N	TGM-47SDH:-N	TGM-72SDH:-N
Voltage	115/60/1	115/60/1	115/60/1	115/60/1	115/60/1
Plug Type	Ⓢ NEMA 5-15P	Ⓢ NEMA 5-15P	Ⓢ NEMA 5-15P	Ⓢ NEMA 5-15P	Ⓢ NEMA 5-15P
Full Load Amp.	2.1	2.2	3.3	6.6	7.8
Compressor HP	1/5	1/5	1/3	2/5	1/2
Cord Length (ft.)	7	7	7	7	7
Refrigerant	R-600a	R-600a	R-290	R-290	R-290
DIMENSIONAL DATA					
Net Capacity (cu. ft.)	14.7	19.02	31.7	44.22	70.44
Bottle Capacity (12oz.)	315 (378 w/add.shelf)	405 (486 w/add.shelf)	690 (828 w/add. shelf)	900 (1,080 w/add. shelf)	1,475 (1,770 w/add. shelf)
Ext. Dimension (L x D x H) (in.)	26 3/8 x 24 3/4* x 75 5/8†	27 x 30 3/8* x 77‡	39 1/2 x 31 7/8* x 77‡	51 1/8 x 31 7/8* x 77‡	78 x 31 7/8* x 77‡
# of Doors	1	1	2	2	3
# of Shelves	4	4	8	8	12
Shelf Size (L x D) (in.)	21 x 17	21 1/2 x 22 1/2	17 x 22 1/2	22 1/2 x 23	22 3/4 x 23 3/4 (L/R), 24 3/4 x 23 3/4 (M)
Net Weight (lbs.)	258	304	385	432	634
Gross Weight (lbs.)	281	325	450	510	732

Design and specifications subject to change without notice. Most updated spec sheets are available at www.turboairinc.com.

Actual shipping weight may differ due to extra packing materials for product protection.

* Depth does not include 2-1/4" for door handles. † Height does not include 1-3/4" for cabinet reinforcement. ‡ Height does not include 2-1/2" for cabinet reinforcement.

■ **WARRANTY: 5 Year Parts and Labor Warranty, 7 Year Compressor Warranty**

GLASS DOOR FREEZERS NATURAL Refrigerant

Self-Cleaning Condenser Equipped Units

Self-Cleaning Condenser (Patented)

The accumulation of dust in the condenser can cause the failure or breakdown of refrigerators. Refrigerators run normally until they reach a certain level of accumulation. At some point, when they are over the limit, their performance drops quickly resulting in damage to, or disposal of the stored products inside. The Self-Cleaning Condenser device keeps the condenser clean and prevents system failure by automatically brushing daily (except TGF-5SD-N).

Digital temperature control & monitor system (except TGF-5SD-N)

- Keeps food products safe by maintaining constant temperatures
- Alarms that sound when doors are not sealed shut; protects against food spoilage that originate from cold air leaks
- Early Warning Alarm program detect issues before malfunction occurs
- Digital display allows for easy monitoring
- Programs interpret the condition of refrigeration systems by self-diagnosis
- Rapid cool-down function (Turbo Freeze)
- Smart defrost system will defrost as needed
- Automatic evaporator fan motor delays

Hydrocarbon refrigerants (R-290)

With innovative and eco-friendly technology, Turbo Air brings you hydrocarbon refrigerators designed to meet DOE's Energy Conservation Standards in 2017 and to use EPA's SNAP Program approved HC refrigerants. Hydrocarbon refrigerants do not deplete the ozone layer and have very low contribution to global warming (ODP-0, GWP-3).

Energy conserving fan control

Utilizing algorithmic air circulation for optimal temperature levels, our innovative fan control system conserves energy by at least 15% and increases compressor life by up to 30% (except TGF-5SD-N).

No electrical cabinet heater is needed

Turbo Air is the first in the industry to replace a frame heater with a method using compressor-produced heat. This eliminates any unnecessary energy consumption while providing efficient freezing performance.

Shadow free advertising panel

Turbo Air is a pioneer in the refrigerator industry on applying special LED Light Guided Panels (LGP). LGP increases panel visibility and eliminates shadows, enhancing any store atmosphere with eye-catching effects. LED lighting offers 5 times longer lasting life than fluorescents and conserves energy (except TGF-5SD/10SD-N).

High-density polyurethane insulation

The entire cabinet structure is foamed-in-place using high density, HCFC free polyurethane insulation.



Self-Cleaning Condenser
Maintenance-free
during warranty period

TGF-10SDW-N



TGF-23SDB-N

Triple pane heated glass doors

Equipped with unique triple-pane heated glass doors which enhance energy efficiency by preventing heat transfers and minimizing condensation. Lightweight door construction reduces door maintenance, bushing wear, and facilitates smooth door opening.

LED interior lighting

Freezer holds -10°F ~ 5°F for the best in frozen food preservation

Standard features

- Anti-corrosion coated evaporator
- Door locks
- ‡ Two color options available: Super Deluxe series comes in white cabinet (W) and black cabinet with black color trim (B).

Optional features

- Price tag channel available (except TGF-5SD/10SD-N)
- 4" dia. casters available -1/2" dia. & 13 TPI (except TGF-5SD-N)

TGF SUPER DELUXE MODELS SPECIFICATIONS

ELECTRICAL DATA	TGF-5SD:-N	TGF-10SD:-N	TGF-15SD:-N	TGF-23SD:-N
Voltage	115/60/1	115/60/1	115/60/1	115/60/1
Plug Type	Ⓜ NEMA 5-15P	Ⓜ NEMA 5-15P	Ⓜ NEMA 5-15P	Ⓜ NEMA 5-15P
Full Load Amp.	2.3	2.6	5.6	6.0
Compressor HP	1/3	1/3	1/2	1/2
Cord Length (ft.)	7	7	7	7
Refrigerant	R-290	R-290	R-290	R-290
DIMENSIONAL DATA				
Net Capacity (cu. ft.)	4.26	7.92	13.2	17.99
Ext. Dimension (L x D x H) (in.)	25 x 23 1/4* x 30 1/2 †	25 3/4 x 23 1/4** x 54 3/8 ‡	26 3/8 x 24 3/4** x 75 5/8 ‡	27 x 30 1/4** x 77 ‡
# of Doors	1	1	1	1
# of Shelves	2	3	4	4
Shelf Size (L x D) (in.)	19 3/8 x 16 5/8	20 x 15 1/2	20 1/2 x 16 1/2	21 1/2 x 22 1/2
Net Weight (lbs.)	164	245	290	343
Gross Weight (lbs.)	195	267	313	365

Design and specifications subject to change without notice. Most updated spec sheets are available at www.turboairinc.com.

Actual shipping weight may differ due to extra packing materials for product protection.

* Depth does not include 2-3/8" for rear mechanical component, 1-5/8" for a power cord bushing plus radius of curvature and 2-1/4" for door handle. ** Depth does not include 2-1/4" for door handle.

† Height does not include 2-1/4" for leg height. ‡ Height does not include 1-5/8" for cabinet reinforcement. #Height does not include 2-1/2" for cabinet reinforcement.

WARRANTY: 5 Year Parts and Labor Warranty, 7 Year Compressor Warranty

GLASS DOOR FREEZERS NATURAL Refrigerant

Self-Cleaning Condenser Equipped Units

Self-Cleaning Condenser (Patented)

The accumulation of dust in the condenser can cause the failure or breakdown of refrigerators. Refrigerators run normally until they reach a certain level of accumulation. At some point, when they are over the limit, their performance drops quickly resulting in damage to, or disposal of the stored products inside. The Self-Cleaning Condenser device keeps the condenser clean and prevents system failure by automatically brushing daily.

Digital temperature control & monitor system

- Keeps food products safe by maintaining constant temperatures
- Alarms that sound when doors are not sealed shut; protects against food spoilage that originates from cold air leaks
- Early Warning Alarm program detects issues before malfunction occurs
- Digital display allows for easy monitoring
- Programs interpret the condition of refrigeration systems by self-diagnosis
- Rapid cool-down function (Turbo Freeze)
- Smart defrost system will defrost as needed
- Automatic evaporator fan motor delays

Hydrocarbon refrigerants (R-290)

With innovative and eco-friendly technology, Turbo Air brings you hydrocarbon refrigerators designed to meet DOE's Energy Conservation Standards in 2017 and to use EPA's SNAP Program approved HC refrigerants. Hydrocarbon refrigerants do not deplete the ozone layer and have very low contribution to global warming (ODP-0, GWP-3).

Energy conserving fan control

Utilizing algorithmic air circulation for optimal temperature levels, our innovative fan control system conserves energy by at least 15% and increases compressor life by up to 30%.

Individual two cycle refrigeration systems (TGF-72SD-N only)

No electrical cabinet heater is needed

Turbo Air is the first in the industry to replace a frame heater with a method using compressor-produced heat. This eliminates any unnecessary energy consumption while providing efficient freezing performance.

Shadow free advertising panel

Turbo Air is a pioneer in the refrigerator industry on applying special LED Light Guided Panels (LGP). LGP increases panel visibility and eliminates shadows, enhancing any store atmosphere with eye-catching effects. LED lighting offers 5 times longer lasting life than fluorescents and conserves energy.

Triple pane heated glass doors

Equipped with unique triple-pane heated glass doors which enhance energy efficiency by preventing heat transfers and minimizing condensation. Lightweight door construction reduces door maintenance, bushing wear, and facilitates smooth door opening.



Self-Cleaning Condenser
Maintenance-free
during warranty period

TGF-72SDW-N

TGF-47SDB-N

2 & 3 Glass Door Freezers powered by 115V

Turbo Air's 2 & 3 Glass Door Freezers are powered by 115V. Not only is the 115V simple and easy to plug in and operate, it also saves customers over \$1,000 in electrical line installation for 220V powered glass door freezers. This feature is proof of our dedication to energy efficiency and the environment.

LED interior lighting

Freezer holds -10°F ~ 5°F for the best in frozen food preservation

Standard features

- Anti-corrosion coated evaporator
- Door locks
- High-density polyurethane insulation
- Two color options available: Super Deluxe series comes in white cabinet (W), and black cabinet with black color trim (B).

Optional features

- Price tag channel available
- 4" dia. casters available -1/2" dia. & 13 TPI

TGF SUPER DELUXE MODELS SPECIFICATIONS

ELECTRICAL DATA	TGF-35SD:-N	TGF-47SD:-N	TGF-72SD:-N
Voltage	115/60/1	115/60/1	115/60/1
Plug Type	Ⓢ NEMA 5-20P	Ⓢ NEMA 5-20P	Ⓢ NEMA 5-20P
Full Load Amp.	8.1	10.4	15.7
Compressor HP	2/3	3/4	(2) 2/3
Cord Length (ft.)	7	7	7
Refrigerant	R-290	R-290	R-290
DIMENSIONAL DATA			
Net Capacity (cu. ft.)	28.44	39	60.43
Ext. Dimension (L x D x H) (in.)	39 1/2 x 31 7/8* x 77†	51 1/8 x 31 7/8* x 77†	78 x 31 7/8* x 77†
# of Doors	2	2	3
# of Shelves	8	8	12
Shelf Size (L x D) (in.)	17 x 22 1/2	22 1/2 x 23	22 3/4 x 23 3/4 (L/R), 24 3/4 x 23 3/4 (M)
Net Weight (lbs.)	454	513	818
Gross Weight (lbs.)	519	590	915

Design and specifications subject to change without notice. Most updated spec sheets are available at www.turboairinc.com.

Actual shipping weight may differ due to extra packing materials for product protection.

* Depth does not include 2-1/4" for door handles. † Height does not include 2-1/2" for cabinet reinforcement.

WARRANTY: 5 Year Parts and Labor Warranty, 7 Year Compressor Warranty

FULL VIEW GLASS DOOR FREEZERS NATURAL Refrigerant

Self-Cleaning Condenser Equipped Units

■ **Self-Cleaning Condenser (Patented)**

The accumulation of dust in the condenser can cause the failure or breakdown of refrigerators. Refrigerators run normally until they reach a certain level of accumulation. At some point, when they are over the limit, their performance drops quickly resulting in damage to, or disposal of the stored products inside. The Self-Cleaning Condenser device keeps the condenser clean and prevents system failure by automatically brushing daily.

■ **Digital temperature control & monitor system**

- Keeps food products safe by maintaining constant temperatures
- Alarms that sound when doors are not sealed shut; protects against food spoilage that originates from cold air leaks
- Early Warning Alarm program detects issues before malfunction occurs
- Digital display allows for easy monitoring
- Programs interpret the condition of refrigeration systems by self-diagnosis
- Rapid cool-down function (Turbo Freeze)
- Smart defrost system will defrost as needed
- Automatic evaporator fan motor delays

■ **Hydrocarbon refrigerants (R-290)**

With innovative and eco-friendly technology, Turbo Air brings you hydrocarbon refrigerators designed to meet DOE's Energy Conservation Standards in 2017 and to use EPA's SNAP Program approved HC refrigerants. Hydrocarbon refrigerants do not deplete the ozone layer and have very low contribution to global warming (ODP-0, GWP-3).

■ **Energy conserving fan control**

Utilizing algorithmic air circulation for optimal temperature levels, our innovative fan control system conserves energy by at least 15% and increases compressor life by up to 30%.

■ **Individual two cycle refrigeration systems (only TGF-72SDH-N)**

■ **No electrical cabinet heater is needed**

Turbo Air is the first in the industry to replace a frame heater with a method of using compressor-produced heat. This eliminates any unnecessary energy consumption while providing efficient freezing performance.

■ **Triple pane heated glass doors**

Equipped with unique triple-pane heated glass doors which enhance energy efficiency by preventing heat transfers and minimizing condensation. Lightweight door construction reduces door maintenance, bushing wear, and facilitates smooth door opening.

■ **LED interior lighting**

■ **Freezer holds -10°F ~ 5°F for the best in frozen food preservation**



Self-Cleaning Condenser Maintenance-free during warranty period

TGF-35SDHW-N



TGF-23SDHB-N

2 & 3 Glass Door Freezers powered by 115V

Turbo Air's 2 & 3 Glass Door Freezers are powered by 115V. Not only is the 115V simple and easy to plug in and operate, it also saves customers over \$1,000 in electrical line installation for 220V powered glass door freezers. This feature is proof of our dedication to energy efficiency and the environment.

■ **Standard features**

- Anti-corrosion coated evaporator
- Door locks
- High-density polyurethane insulation
- ‡ Two color options available: Super Deluxe series comes in white cabinet (W) or black cabinet with black color trim (B).

■ **Optional features**

- Price tag channel available
- 4" dia. casters available -1/2" dia. & 13 TPI

TGF SUPER DELUXE MODELS SPECIFICATIONS

ELECTRICAL DATA	TGF-23SDH:-N	TGF-35SDH:-N	TGF-47SDH:-N	TGF-72SDH:-N
Voltage	115/60/1	115/60/1	115/60/1	115/60/1
Plug Type	Ⓢ NEMA 5-15P	Ⓢ NEMA 5-20P	Ⓢ NEMA 5-20P	Ⓢ NEMA 5-20P
Full Load Amp.	5.8	7.6	9.1	13.6
Compressor HP	1/2	2/3	3/4	2/3 x 2
Cord Length (ft.)	7	7	7	7
Refrigerant	R-290	R-290	R-290	R-290
DIMENSIONAL DATA				
Net Capacity (cu. ft.)	17.94	30.94	42.12	62.2
Ext. Dimension (L x D x H) (in.)	27 x 30 ^{3/8} x 77 [†]	39 ^{1/2} x 31 ^{7/8} x 77 [†]	51 ^{1/8} x 31 ^{7/8} x 77 [†]	78 x 31 ^{7/8} x 77 [†]
# of Doors	1	2	2	3
# of Shelves	4	8	8	12
Shelf Size (L x D) (in.)	21 ^{1/2} x 22 ^{1/2}	17 x 22 ^{1/2}	22 ^{1/2} x 23	22 ^{3/4} x 23 ^{3/4} (L/R), 24 ^{3/4} x 23 ^{3/4} (M)
Net Weight (lbs.)	343	454	513	818
Gross Weight (lbs.)	365	519	590	915

Design and specifications subject to change without notice. Most updated spec sheets are available at www.turboairinc.com.

Actual shipping weight may differ due to extra packing materials for product protection.

* Depth does not include 2-1/4" for door handles. † Height does not include 2-1/2" for cabinet reinforcement.

■ **WARRANTY: 5 Year Parts and Labor Warranty, 7 Year Compressor Warranty**

JUMBO ICE MERCHANDISERS NATURAL Refrigerant

Self-Cleaning Condenser Equipped Units

■ **Self-Cleaning Condenser (Patented)**

The accumulation of dust in the condenser can cause the failure or breakdown of refrigerators. Refrigerators run normally until they reach a certain level of accumulation. At some point, when they are over the limit, their performance drops quickly resulting in damage to, or disposal of the stored products inside. The Self-Cleaning Condenser device keeps the condenser clean and prevents system failure by automatically brushing daily.

■ **Digital temperature control & monitor system**

- Keeps food products safe by maintaining constant temperatures
- Alarms that sound when doors are not sealed shut; protects against food spoilage that originates from cold air leaks
- Digital display allows for easy monitoring
- Programs interpret the condition of refrigeration systems by self-diagnosis
- Rapid cool-down function (Turbo Freeze)
- Smart defrost system will defrost as needed
- Automatic evaporator fan motor delays

■ **Hydrocarbon refrigerants (R-290)**

With innovative and eco-friendly technology, Turbo Air brings you hydrocarbon refrigerators designed to meet DOE's Energy Conservation Standards in 2017 and to use EPA's SNAP Program approved HC refrigerants. Hydrocarbon refrigerants do not deplete the ozone layer and have very low contribution to global warming (ODP-0, GWP-3).

■ **Ice stays frozen even in hot climates**

Turbo Air ice merchandisers are based on a freezer system that is adjusted to the ideal temperature range for bagged ice storage, whereas our competitors use refrigerator based systems. This system maintains an avg. temperature of 12°F or lower, which eliminates the problem of ice melting during hot weather conditions.

■ **Triple pane heated glass doors**

Equipped with unique triple-pane heated glass doors which enhance energy efficiency by preventing heat transfers and minimizing condensation. Lightweight door construction reduces door maintenance, bushing wear, and facilitates smooth door opening.

■ **No electrical cabinet heater is needed**

Electrical heaters in freezers operate 24/7 in order to prevent water flow to the cabinet surface. This causes unnecessary energy consumption, and sometimes is the reason behind overheating. Instead of frame heaters, Turbo Air freezers harness the heat produced by the compressor during its condensing stage, eliminating any unnecessary energy consumption as well as providing the most efficient freezer performance available.



Self-Cleaning Condenser
Maintenance-free during warranty period

TJMI-55SDW-N

Benefits over Remote Units

- Loading capacity is the same as an endless remote unit
- No plumbing required
- No installation work required
- Low maintenance expenses
- Energy saving
- Easy to relocate

■ **Freezer holds 10°F ~ 15°F for the best in bagged ice storage**

■ **Standard feature**

- White and black colors come standard
- Lead time applies

TJMI MODELS SPECIFICATIONS

ELECTRICAL DATA		TJMI-55SDW(B)-N
Voltage		115/60/1
Plug Type		Ⓢ NEMA 5-20P
Full Load Amp.		8.8
Compressor HP		1/2 x 2
Cord Length (ft.)		8.5
Refrigerant		R-290
DIMENSIONAL DATA		
Net Capacity (cu. ft.)		60.04
Ext. Dimension (L x D x H) (in.)		65 1/8 x 38* x 83 1/2
# of Doors		2
# of Shelves (Rack/Bottom)		6 (4/2)
Bottom Shelf Size (L x D) (in.)		28 5/8 x 28 1/4
Net Weight (lbs.)		701
Gross Weight (lbs.)		798

Design and specifications subject to change without notice. Most updated spec sheets are available at www.turboairinc.com.

Actual shipping weight may differ due to extra packing materials for product protection.

* Depth does not include 2-1/4" for door handles.

■ **WARRANTY: 5 Year Parts and Labor Warranty, 7 Year Compressor Warranty**

GLASS DOOR MERCHANDISERS **NATURAL Refrigerant**

■ Hydrocarbon refrigerants (R-600a)

With innovative and eco-friendly technology, RefrigerationX brings you hydrocarbon refrigerators designed to meet DOE's Energy Conservation Standards in 2017 and to use EPA's SNAP Program approved HC refrigerants. Hydrocarbon refrigerants do not deplete the ozone layer and have very low contribution to global warming (ODP-0, GWP-3).

■ Energy conserving fan control

Utilizing algorithmic air circulation for optimal temperature levels, our innovative fan control system conserves energy by at least 15% and increases compressor life by up to 30%.

■ Double pane glass doors with Low-E glass

Energy saving double pane glass doors are equipped with Low-emissivity glass, which reduces outer heat gain and decreases energy consumption. It enhances energy efficiency and minimizes condensation. Lightweight door construction also reduces door maintenance and bushing wear, which in turn facilitates smoother door opening.

■ High-density polyurethane insulation

The entire cabinet structure is foamed-in-place using high density, HCFC free polyurethane insulation.

■ LED interior lighting

■ Adjustable PE (polyethylene) coated wire shelves

■ Refrigerator holds 33°F ~ 38°F for the best in food preservation

■ Standard features

- Anti-corrosion coated evaporator
- White and black colors come standard
- 2" dia. casters with non-brake on the rear set
- Two color options available: white cabinet (W), black cabinet (B).

■ Optional features

- 2" dia. swivel plate mount casters are available
- Additional PE coated wire shelf available



TGM-10W-N6



TGM-19B-N6

TGM MODELS SPECIFICATIONS

ELECTRICAL DATA	TGM-10W(B)-N6	TGM-15W(B)-N6	TGM-19W(B)-N6	TGM-23W(B)-N6
Voltage	115/60/1	115/60/1	115/60/1	115/60/1
Plug Type	Ⓜ NEMA 5-15P	Ⓜ NEMA 5-15P	Ⓜ NEMA 5-15P	Ⓜ NEMA 5-15P
Full Load Amp.	2.6	2.5	2.7	2.8
Compressor HP	1/4	1/4	1/4	1/4
Cord Length (ft.)	7	7	7	7
Refrigerant	R-600a	R-600a	R-600a	R-600a
DIMENSIONAL DATA				
Net Capacity (cu. ft.)	8.93	14.44	15.09	18.9
Bottle Capacity (12oz)	205	253	292	377
Ext. Dimension (L x D x H) (in.)	26 ³ / ₈ x 25* x 55 ³ / ₈ †	26 ³ / ₈ x 25* x 76 ³ / ₄ †	26 ³ / ₈ x 26 ¹ / ₂ * x 78 ¹ / ₈ †	26 ³ / ₈ x 32* x 78 ¹ / ₈ †
# of Doors	1	1	1	1
# of Shelves	3	4	4	4
Shelf Size (L x D) (in.)	20 ⁵ / ₈ x 16	20 ⁵ / ₈ x 16	20 ⁵ / ₈ x 17 ¹ / ₂	20 ⁵ / ₈ x 23
Net Weight (lbs.)	179	231	251	263
Gross Weight (lbs.)	212	265	286	309

Design and specifications subject to change without notice. Most updated spec sheets are available at www.turboairinc.com.

Actual shipping weight may differ due to extra packing materials for product protection.

* Depth does not include 1-5/8" for door handle. † Height does not include 2-5/8" for caster height.

■ WARRANTY: 2 Year Parts and Labor Warranty, 5 Year Compressor Warranty

GLASS DOOR MERCHANDISERS NATURAL Refrigerant

■ **Hydrocarbon refrigerants (R-290)**

With innovative and eco-friendly technology, Turbo Air brings you hydrocarbon refrigerators designed to meet DOE's Energy Conservation Standards in 2017 and to use EPA's SNAP Program approved HC refrigerants. Hydrocarbon refrigerants do not deplete the ozone layer and have very low contribution to global warming (ODP-0, GWP-3).

■ **Energy conserving fan control**

Utilizing algorithmic air circulation for optimal temperature levels, our innovative fan control system conserves energy by at least 15% and increases compressor life by up to 30%.

■ **Hot gas condensate system**

Through Turbo Air's creative innovation, the condensate system surfaces have been specially treated to resist corrosion. This not only increases efficiency without the risk of refrigerant leakage from corrosion, but also prevents the overflow of condensate water.

■ **LED advertising panel**

LED lighting offers 5 times longer lasting life than fluorescents and conserves energy.

■ **Double pane glass doors with Low-E glass**

Energy saving double pane glass doors are equipped with Low-emissivity glass, which reduces outer heat gain and decreases energy consumption. It enhances energy efficiency and minimizes condensation. Lightweight door construction also reduces door maintenance and bushing wear, which in turn facilitates smoother door opening.

■ **High-density polyurethane insulation**

The entire cabinet structure and solid doors are foamed-in-place using high density, HCFC free polyurethane insulation.

■ **Adjustable, heavy duty, PE (polyethylene) coated wire shelves**

■ **LED interior lighting**

■ **Refrigerator holds 33°F ~ 38°F for the best in beverage preservation**



TGM-72RS-N



TGM-50RSB-N

■ **Standard features**

- Anti-corrosion coated evaporator
- White and black colors come standard

■ **Optional features**

- 4" dia. casters are available
- Price tag channel available

TGM MODELS SPECIFICATIONS

ELECTRICAL DATA	TGM-50RS(B)-N	TGM-72RS(B)-N
Voltage	115/60/1	115/60/1
Plug Type	Ⓢ NEMA 5-15P	Ⓢ NEMA 5-15P
Full Load Amp.	3.1	6.8
Compressor HP	1/3	1/2
Cord Length (ft.)	7	7
Refrigerant	R-290	R-290
DIMENSIONAL DATA		
Net Capacity (cu. ft.)	45.97	67.98
Bottle Capacity (Full / Load line)	560 / 448	840 / 672
Ext. Dimension (L x D x H) (in.)	55 7/8 x 32* x 78 1/2	78 x 32* x 79 1/4
# of Doors	2	3
# of Shelves	8	12
Shelf Size (L x D) (in.)	25 1/4 x 23 3/8	23 1/2 x 23
Net Weight (lbs.)	474	705
Gross Weight (lbs.)	516	733

Design and specifications subject to change without notice. Most updated spec sheets are available at www.turboairinc.com.

Actual shipping weight may differ due to extra packing materials for product protection.

* Depth does not include 1-3/8" for door handles.

■ **WARRANTY: 2 Year Parts and Labor Warranty, 5 Year Compressor Warranty**

GLASS DOOR MERCHANDISERS NATURAL Refrigerant

■ **Hydrocarbon refrigerants (R-290)**

With innovative and eco-friendly technology, Turbo Air brings you hydrocarbon refrigerators designed to meet DOE's Energy Conservation Standards in 2017 and to use EPA's SNAP Program approved HC refrigerants. Hydrocarbon refrigerants do not deplete the ozone layer and have very low contribution to global warming (ODP-0, GWP-3).

■ **Energy conserving fan control**

Utilizing algorithmic air circulation for optimal temperature levels, our innovative fan control system conserves energy by at least 15% and increases compressor life by up to 30%.

■ **Hot gas condensate system**

Through Turbo Air's creative innovation, the condensate system surfaces have been specially treated to resist corrosion. This not only increases efficiency without the risk of refrigerant leakage from corrosion, but also prevents the overflow of condensate water.

■ **Double pane glass doors with Low-E glass**

Energy saving double pane glass doors are equipped with Low-emissivity glass, which reduces outer heat gain and decreases energy consumption. It enhances energy efficiency and minimizes condensation. Lightweight door construction also reduces door maintenance and bushing wear, which in turn facilitates smoother door opening.

■ **High-density polyurethane insulation**

The entire cabinet structure and solid doors are foamed-in-place using high density, HCFC free polyurethane insulation.

■ **Adjustable, heavy duty, PE (polyethylene) coated wire shelves**

■ **LED advertising panel**

LED lighting offers 5 times longer lasting life than fluorescents and conserves energy.

■ **LED interior lighting**

■ **Refrigerator holds 33°F ~ 38°F for the best in beverage preservation**



TGM-69R-N



TGM-48RB-N

■ **Standard features**

- Anti-corrosion coated evaporator
- White color cabinet & black color frame on door (TGM-35R-N)
- White and black cabinet colors available (TGM-48R(B)-N, TGM-69R(B)-N)

■ **Optional features**

- 4" dia. casters are available

TGM MODELS SPECIFICATIONS

ELECTRICAL DATA	TGM-35R-N	TGM-48R(B)-N	TGM-69R(B)-N
Voltage	115/60/1	115/60/1	115/60/1
Plug Type	Ⓢ NEMA 5-15P	Ⓢ NEMA 5-15P	Ⓢ NEMA 5-15P
Full Load Amp.	3.2	5.7	6.8
Compressor HP	1/3	1/2	1/2
Cord Length (ft.)	7	7	7
Refrigerant	R-290	R-290	R-290
DIMENSIONAL DATA			
Net Capacity (cu. ft.)	29.27	44	61.83
Bottle Capacity (Full / Load line)	420 / 336	560 / 448	840 / 672
Ext. Dimension (L x D x H) (in.)	41 ³ / ₈ x 30* x 79 ¹ / ₈	55 ⁷ / ₈ x 30* x 79 ¹ / ₈	78 x 30 ¹ / ₈ * x 79 ⁵ / ₈
# of Doors	2	2	3
# of Shelves	8	8	12
Shelf Size (L x D) (in.)	18 x 23 ³ / ₈	25 ¹ / ₄ x 23 ³ / ₈	23 ¹ / ₂ x 23
Net Weight (lbs.)	410	463	654
Gross Weight (lbs.)	419	486	681

Design and specifications subject to change without notice. Most updated spec sheets are available at www.turboairinc.com.

Actual shipping weight may differ due to extra packing materials for product protection.

* Depth does not include 3/4" for door handles.

■ **WARRANTY: 2 Year Parts and Labor Warranty, 5 Year Compressor Warranty**

GLASS DOOR FREEZERS NATURAL Refrigerant

Digital temperature control & monitor system

- Keeps food products safe by maintaining constant temperatures
- Alarms that sound when doors are not sealed shut; protects against food spoilage that originates from cold air leaks
- Digital display allows for easy monitoring
- Programs interpret the condition of refrigeration systems by self-diagnosis
- Rapid cool-down function (Turbo Freeze)
- Smart defrost system will defrost as needed
- Automatic evaporator fan motor delays

Hydrocarbon refrigerants (R-290)

With innovative and eco-friendly technology, Turbo Air brings you hydrocarbon refrigerators designed to meet DOE's Energy Conservation Standards in 2017 and to use EPA's SNAP Program approved HC refrigerants. Hydrocarbon refrigerants do not deplete the ozone layer and have very low contribution to global warming (ODP-0, GWP-3).

Individual two cycle refrigeration systems (only TGF-72F(B)-N)

Triple pane heated glass doors

Equipped with unique triple-pane heated glass doors which enhance energy efficiency by preventing heat transfers and minimizing condensation. Lightweight door construction reduces door maintenance, bushing wear, and facilitates smooth door opening.

High-density polyurethane insulation

The entire cabinet structure is foamed-in-place using high density, HCFC free polyurethane insulation.

Ergonomically designed doors

Customers' fatigue fades away with easy grip handles and doors that open effortlessly. These features along with self-closing doors make this the ultimate choice in customer convenience.

LED advertising panel

LED lighting offers 5 times longer lasting life than fluorescents and conserves energy.

Adjustable, heavy duty, PE (polyethylene) coated wire shelves

LED interior lighting

Freezer holds -10°F ~ 5°F for the best in frozen food preservation



TGF-72FB-N

TGF-49F-N

2 & 3 Glass Door Freezers powered by 115V

Turbo Air's 2 & 3 Glass Door Freezers are powered by 115V. Not only is the 115V simple and easy to plug in and operate, it also saves customers over \$1,000 in electrical line installation for 220V powered glass door freezers. This feature is proof of our dedication to energy efficiency and the environment.

Standard features

- Anti-corrosion coated evaporator
- Magnetic door gaskets
- White and black colors come standard

Optional features

- 4" dia. swivel casters available
- Price tag channel available

TGF MODELS SPECIFICATIONS

ELECTRICAL DATA	TGF-23F(B)-N	TGF-49F(B)-N	TGF-72F(B)-N
Voltage	115/60/1	115/60/1	115/60/1
Plug Type	Ⓜ NEMA 5-15P	Ⓜ NEMA 5-20P	Ⓜ NEMA 5-20P
Full Load Amp.	5.3	9.8	15.2
Compressor HP	1/2	1	2/3 x 2
Cord Length (ft.)	7	7	7
Refrigerant	R-290	R-290	R-290
DIMENSIONAL DATA			
Net Capacity (cu. ft.)	17.7	39.88	58.45
Ext. Dimension (L x D x H) (in.)	27 x 29 3/4* x 78 1/4	54 3/8 x 29 3/4* x 78 1/4	81 7/8 x 29 3/4* x 78 1/4
# of Doors	1	2	3
# of Shelves	4	8	12
Shelf Size (L x D) (in.)	21 1/2 x 22 1/2	24 3/4 x 23	25 x 22 1/4
Net Weight (lbs.)	355	554	800
Gross Weight (lbs.)	376	587	848

Design and specifications subject to change without notice. Most updated spec sheets are available at www.turboairinc.com.

Actual shipping weight may differ due to extra packing materials for product protection.

* Depth does not include 1-3/8" for glass door handles.

WARRANTY: 2 Year Parts and Labor Warranty, 5 Year Compressor Warranty

ICE MERCHANDISERS NATURAL Refrigerant

Self-Cleaning Condenser Equipped Units

Self-Cleaning Condenser (Patented)

The accumulation of dust in the condenser can cause the failure or breakdown of refrigerators. Refrigerators run normally until they reach a certain level of accumulation. At some point, when they are over the limit, their performance drops quickly resulting in damage to, or disposal of the stored products inside. The Self-Cleaning Condenser device keeps the condenser clean and prevents system failure by automatically brushing daily.

Digital temperature control & monitor system

- Keeps food products safe by maintaining constant temperatures
- Alarms that sound when doors are not sealed shut; protects against food spoilage that originates from cold air leaks
- Digital display allows for easy monitoring
- Programs interpret the condition of refrigeration systems by self-diagnosis
- Rapid cool-down function (Turbo Freeze)
- Smart defrost system will defrost as needed
- Automatic evaporator fan motor delays

Hydrocarbon refrigerants (R-290)

With innovative and eco-friendly technology, Turbo Air brings you hydrocarbon refrigerators designed to meet DOE's Energy Conservation Standards in 2017 and to use EPA's SNAP Program approved HC refrigerants. Hydrocarbon refrigerants do not deplete the ozone layer and have very low contribution to global warming (ODP-0, GWP-3).

Ice stays frozen even in hot climates

Turbo Air ice merchandisers are based on a freezer system that is adjusted to the ideal temperature range for bagged ice storage, whereas our competitors use refrigerator based systems. This system maintains an avg. temperature of 12°F or lower, which eliminates the problem of ice melting during hot weather conditions.

Triple pane heated glass doors

Equipped with unique triple-pane heated glass doors which enhance energy efficiency by preventing heat transfers and minimizing condensation. Lightweight door construction reduces door maintenance, bushing wear, and facilitates smooth door opening.

No electrical cabinet heater is needed

Electrical heaters in freezers operate 24/7 in order to prevent water flow to the cabinet surface. This causes unnecessary energy consumption, and sometimes is the reason behind overheating. Instead of frame heaters, Turbo Air freezers harness the heat produced by the compressor during its condensing stage, eliminating any unnecessary energy consumption as well as providing the most efficient freezer performance available.

High-density polyurethane insulation

The entire cabinet structure is foamed-in-place using high density, HCFC free polyurethane insulation.

LED advertising panel

LED lighting offers 5 times longer lasting life than fluorescents and conserves energy.



Self-Cleaning Condenser
Maintenance-free
during warranty period

TGIM-49W-N

TGIM-23W-N

LED interior lighting

Bottom mount compressor units

Turbo Air's bottom mount compressor allows easier access for service and extra storage space above. In addition, the lower area provides a cooler and less greasy operating environment which results in reduced compressor running time.

Freezer holds 10°F ~ 15°F for the best in bagged ice storage

Standard feature

- Anti-corrosion coated evaporator
- Magnetic door gaskets

Optional features

- 4" dia. swivel casters available

TGIM MODELS SPECIFICATIONS

ELECTRICAL DATA	TGIM-23W-N	TGIM-49W-N
Voltage	115/60/1	115/60/1
Plug Type	Ⓜ NEMA 5-15P	Ⓜ NEMA 5-20P
Full Load Amp.	3.0	6.7
Compressor HP	2/5	3/4
Cord Length (ft.)	7	7
Refrigerant	R-290	R-290
DIMENSIONAL DATA		
Net Capacity (cu. ft.)	17.7	39.88
Ext. Dimension (L x D x H) (in.)	27 x 29 ^{3/4} x 78 ^{1/4}	54 ^{3/8} x 29 ^{3/4} x 78 ^{1/4}
# of Doors	1	2
# of Shelves (Rack/Bottom)	3 (2/1)	6 (4/2)
Bottom Shelf Size (L x D) (in.)	21 ^{3/8} x 20 ^{3/8}	24 ^{1/4} x 20 ^{3/8}
Net Weight (lbs.)	334	505
Gross Weight (lbs.)	356	665

Design and specifications subject to change without notice. Most updated spec sheets are available at www.turboairinc.com.

Actual shipping weight may differ due to extra packing materials for product protection.

* Depth does not include 1-3/8" for glass door handles.

WARRANTY: 2 Year Parts and Labor Warranty, 5 Year Compressor Warranty

TOP OPEN ISLAND FREEZERS NATURAL Refrigerant

■ **Hydrocarbon refrigerants (R-290)**

With innovative and eco-friendly technology, Turbo Air brings you hydrocarbon refrigerators designed to meet DOE's Energy Conservation Standards in 2017 and to use EPA's SNAP Program approved HC refrigerants. Hydrocarbon refrigerants do not deplete the ozone layer and have very low contribution to global warming (ODP-0, GWP-3).

■ **High-density polyurethane insulation**

The entire cabinet structure and solid doors are foamed-in-place using high density, CFC free polyurethane insulation.

■ **Horizontal display freezer for high impulse sales**

Flat lid display freezer provides convenient access and fast service and is ideal for high impulse sales such as frozen treats. Minimal frame glass lids allow excellent visibility with maximum merchandising effect.

■ **Tempered, energy-saving, Low-E glass sliding top**

Energy saving Low-emissivity glass top reduces outer heat gain and lowers energy consumption. Reinforced tempered glass lids for safety.

■ **White, anti-rust coating on the exterior reduces fingerprints**

■ **LED interior lighting with on/off switch**

■ **External digital temperature control**

■ **Painted white powder-coated steel interior**

■ **Two layers of rubber bumper guards around the cabinet**

■ **Manual defrost system with drain**

■ **Wire baskets come standard**

■ **Freezer holds -10°F ~ 8°F for the best in frozen food preservation**



■ **Standard features**

- No plumbing required
- Self-contained system
- 2.5" dia. casters, two locking
- Lead time applies

- **Recommended operating conditions**

These models are designed to operate in air conditioned environments where temperature and humidity are below 75°F and 55% relative humidity. Place units away from direct sunlight, rapid air movement and extreme temperature changes.

TFS MODELS SPECIFICATIONS

ELECTRICAL DATA	TFS-11F-N	TFS-20F-N	TFS-25F-N
Voltage	115/60/1	115/60/1	115/60/1
Plug Type	Ⓜ NEMA 5-15P	Ⓜ NEMA 5-15P	Ⓜ NEMA 5-15P
Full Load Amp.	2.0	4.4	4.6
Compressor HP	1/3	1/2	1/2
Cord Length (ft.)	7	7	7
Refrigerant	R-290	R-290	R-290
DIMENSIONAL DATA			
Net Capacity (cu. ft.)	13.77	20.29	25.22
Net Capacity (Gal.)	103	151.8	188.7
Ext. Dimension (L x D x H) (in.)	40 x 31 1/2 x 31 1/4†	57 3/8 x 31 1/2 x 31 1/4†	69 x 31 1/2 x 31 1/4†
# of Doors	2	2	2
# of Baskets	15	27	33
Basket Size (L x D x H) (in.)	(3) 10 3/8 x 8 x 8 3/4	(3) 10 3/8 x 8 x 8 3/4	(3) 10 3/8 x 8 x 8 3/4
	(12) 11 1/8 x 8 x 9 1/2	(24) 9 5/8 x 8 x 9 1/2	(30) 9 5/8 x 8 x 9 1/2
Net Weight (lbs.)	211	260	470
Gross Weight (lbs.)	368	370	520

Design and specifications subject to change without notice. Most updated spec sheets are available at www.turboairinc.com.

Actual shipping weight may differ due to extra packing materials for product protection.

† Height does not include 3" for caster height.

■ **WARRANTY: 2 Year Parts and Labor Warranty, 5 Year Compressor Warranty**

ICE CREAM DIPPING CABINETS NATURAL Refrigerant

■ **Hydrocarbon refrigerants (R-290)**

With innovative and eco-friendly technology, Turbo Air brings you hydrocarbon refrigerators designed to meet DOE's Energy Conservation Standards in 2017 and to use EPA's SNAP Program approved HC refrigerants. Hydrocarbon refrigerants do not deplete the ozone layer and have very low contribution to global warming (ODP-0, GWP-3).

■ **Locked-in temperature equal from top to bottom**

New technology of the Cold Wall System eliminates temperature fluctuations throughout the top and bottom areas of the interior cabinet. No more melting ice cream above while freezing below. Scooping has never been easier.

■ **5 years cleaning-free condenser**

1/5" condenser pin gaps and electrodeposition coating allow the condenser to stay clean and prevent it from becoming tarnished, further guaranteeing the durability of the condenser.

■ **Low-emissivity front glass and tempered glass sides**

Energy saving Low-emissivity front glass reduces heat transfer and decreases energy consumption. Reinforced tempered safety glass is equipped on both sides.

■ **Attractive contemporary design with curved glass front and top**

Sleek new curved front and top glass is attractive and draws attention at once. Deep lowered glass front optimizes product visibility and impulse buying. This merchandiser is perfect for ice cream viewing and dipping.

■ **LED interior lighting**

Brighter and longer lasting LED light bulbs produce less heat, saving energy while maximizing display effect. Independent on/off light switch equipped.

■ **Extra storage space (except TIDC-26W-N)**

Extra storage space accommodates additional ice cream tubs underneath the basket. Doors located to the rear allow easy access to the storage area eliminating inconvenient bracket usage in picking up ice cream tubs.

■ **Sturdy, clean stainless steel shelves**

■ **PE coated removable magnetic frost shields**

Provides fast and easy removal of accumulated frost on inside walls.

■ **Standard plastic night covers for case opening**

■ **Manual defrost**

■ **Maintains -10°F ~ 8°F for the best in frozen ice cream preservation**

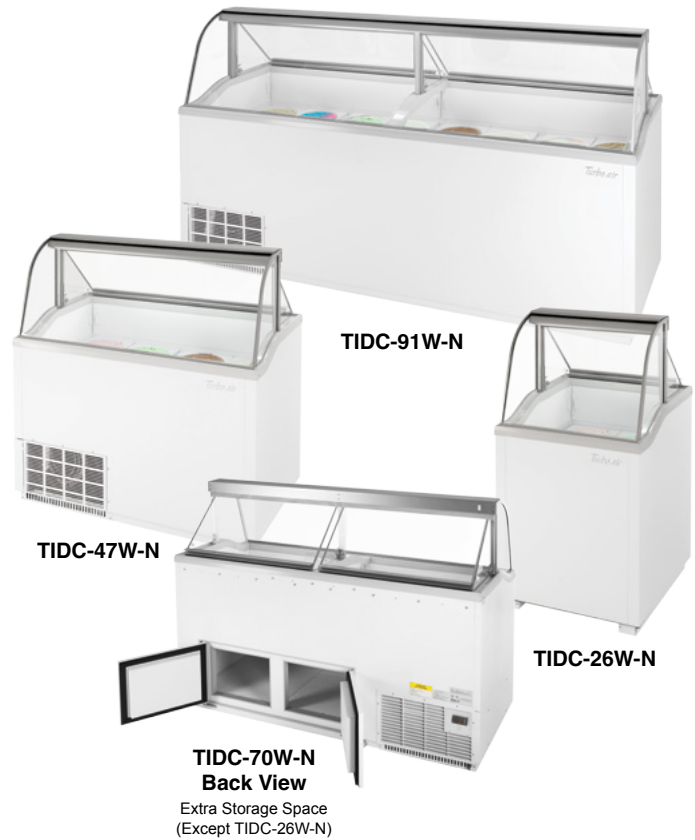

■ **Standard features**

- White exterior color

■ **Optional features**

- 2.5" dia. casters available - 1/2" diameter & 13 TPI

- **Recommended operating conditions**

These models are designed to operate in air conditioned environments where temperature and humidity are below 75°F and 55% relative humidity. Place units away from direct sunlight, rapid air movement and extreme temperature changes.

TIDC MODELS SPECIFICATIONS

ELECTRICAL DATA	TIDC-26W-N	TIDC-47W-N	TIDC-70W-N	TIDC-91W-N
Voltage	115/60/1	115/60/1	115/60/1	115/60/1
Plug Type	Ⓜ NEMA 5-15P	Ⓜ NEMA 5-15P	Ⓜ NEMA 5-15P	Ⓜ NEMA 5-15P
Full Load Amp.	1.9	4.6	6.7	6.9
Compressor HP	1/3	1/2	1	1
Refrigerant	R-290	R-290	R-290	R-290
DIMENSIONAL DATA				
Capacity (3gal. cans) Display / Storage	4 / 0	8 / 4	12 / 8	16 / 12
Ext. Dimension (L x D x H) (in.)	26 x 26 1/8 x 51	47 x 26 1/8 x 50 7/8	68 x 26 1/8 x 50 7/8	89 x 26 1/8 x 50 7/8
# of Lids	1	1	2	2
# of Night Covers	1	2	2	4
# of Shelves	1	2	3	4
Net Weight (lbs.)	172	297	419	551
Gross Weight (lbs.)	227	375	518	673

Design and specifications subject to change without notice. Most updated spec sheets are available at www.turboairinc.com. Actual shipping weight may differ due to extra packing materials for product protection.

■ **WARRANTY: 2 Year Parts and Labor Warranty, 5 Year Compressor Warranty**



Display Cases

Open Display Merchandisers

Horizontal Cases

Slim Profile - Glass / Solid Panel

Low Profile - Glass / Solid Panel

Combination Cases

Curved / European Straight Front

European Straight Horizontal Cases

Low Profile - Glass Panel

Drop In Type - Glass / Solid Panel

Sandwich & Cheese Cases

Vertical Cases

Slim / Medium / Full Height / Extra Deep

Glass / Solid Panel

Vertical Air Curtains

Full / Medium Height

Island Display Cases

Bakery & Deli Display Cases

Curved Glass Deli Cases

Direct Cooling Type

Curved Glass Bakery Cases

Refrigerated / Dry / Dual

European Straight Front Bakery Cases

Refrigerated / Dry / Dual

Bakery Display Cases

HORIZONTAL OPEN DISPLAY CASES NATURAL Refrigerant

Self-Cleaning Condenser Equipped Units

Self-Cleaning Condenser (Patented)

The accumulation of dust in the condenser can cause the failure or breakdown of refrigerators. Refrigerators run normally until they reach a certain level of accumulation. At some point, when they are over the limit, their performance drops quickly resulting in damage to, or disposal of the stored products inside. The Self-Cleaning Condenser device keeps the condenser clean and prevents system failure by automatically brushing daily.

Hydrocarbon refrigerants (R-290)

With innovative and eco-friendly technology, Turbo Air brings you hydrocarbon refrigerators designed to meet DOE's Energy Conservation Standards in 2017 and to use EPA's SNAP Program approved HC refrigerants. Hydrocarbon refrigerants do not deplete the ozone layer and have very low contribution to global warming (ODP-0, GWP-3).

Modern design

By integrating great contours with durable structures, our modern style product designs are user-friendly while maintaining the highest product visibility and aesthetics. Safety reinforced tempered glass front shield and side walls optimize the merchandiser's display effects of fresh salads, sandwiches, desserts and beverages. Its elegant contemporary euro design will enhance any store application. Ideal for eye-catching displays and convenient access with fast service in high traffic areas.

Standard back-guard improves airflow

Stainless steel interior standard including back wall and deck pans

Stainless steel solid shelves standard

Perforated interior back wall & top for improved airflow

Foamed with polyurethane, high-density cell insulation (CFC free)

Front air intake and rear air discharge

Stainless steel color option available

Standard features

- Simple plug-in installation
- No plumbing required
- White and black colors come standard
- Solar powered digital thermometer
- Digital electronic thermostat with defrost control
- LED interior lighting



TOM-60SS-N

TOM-50SB-N & TOMD-50HB

Self-Cleaning Condenser
Maintenance-free during warranty period

Optional features

- Top display dry cases (TOMD-H, L) available in all sizes
- Night cover available
 - * Night cover can not be used in conjunction with a TOMD dry case
- Security cover available
- Leveling leg available
- Casters available

Recommended operating conditions

TOM models are designed to operate in an environment where temperature & humidity do not exceed 80°F and 55% respectively. Units should not be installed near HVAC vents, fans or doorways that will disrupt the air curtain and compromise the function of the cabinet. Air curtain models will run most efficiently when completely loaded with product. When used as a built-in, required clearance for the rear is 4" and the top is 5".

TOM-S / TOMD-H MODELS SPECIFICATIONS

ELECTRICAL/DIMENSIONAL DATA	TOM-30SW(B, S)-N	TOM-40SW(B, S)-N	TOM-50SW(B, S)-N	TOM-60SW(B, S)-N	TOM-75SW(B, S)-N
Voltage	115/60/1	115/60/1	115/60/1	115/60/1	115/60/1
Plug Type	Ⓢ NEMA 5-15P	Ⓢ NEMA 5-15P	Ⓢ NEMA 5-15P	Ⓢ NEMA 5-20P	Ⓢ NEMA 5-20P
Full Load Amp.	7	7.3	7.3	14.7	14.7
Compressor HP	1/3	3/4	3/4	3/4 x 2	3/4 x 2
Refrigerant	R-290	R-290	R-290	R-290	R-290
Net Capacity (cu. ft.)	4.7	6.7	8.9	11.2	13.5
Ext. Dimension (L x D [†] x H [†]) (in.)	28 1/8 x 33 1/2 x 41 1/2	39 1/8 x 33 1/2 x 41 1/2	50 7/8 x 33 1/2 x 41 1/2	63 3/8 x 33 1/2 x 41 1/2	75 3/4 x 33 1/2 x 41 1/2
# of Bottom Shelves	3	3	3	3	3
Shelf Size (L x D) (in.)	Top	25 1/2 x 7 1/8	36 1/2 x 7 1/8	48 1/4 x 7 1/8	60 3/4 x 7 1/8
	Middle	25 1/2 x 14 1/8	36 1/2 x 14 1/8	48 1/4 x 14 1/8	60 3/4 x 14 1/8
	Low	25 1/2 x 9 7/8	36 1/2 x 9 7/8	48 1/4 x 9 7/8	60 3/4 x 9 7/8
Net Weight (lbs.)	255	313	370	440	498
Gross Weight (lbs.)	338	440	481	535	680

DIMENSIONAL DATA	TOMD-30HW(B, S)	TOMD-40HW(B, S)	TOMD-50HW(B, S)	TOMD-60HW(B, S)	TOMD-75HW(B, S)
Ext. Dimension (L x D x H) (in.)	28 x 12 1/4 x 17 3/4	39 x 12 1/4 x 17 3/4	50 3/4 x 12 1/4 x 17 3/4	63 1/4 x 12 1/4 x 17 3/4	75 5/8 x 12 1/4 x 17 3/4
Net Capacity (cu. ft.)	2.1	3	4	5	6.1
# of Shelves (Size (L x D) (in.))	1 (25 1/2 x 7)	1 (36 1/2 x 7)	1 (48 1/4 x 7)	1 (60 3/4 x 7)	1 (73 1/4 x 7)
Net Weight / Gross Weight (lbs.)	48 / 53	66 / 70	81 / 87	99 / 110	111 / 128

Design and specifications subject to change without notice. Most updated spec sheets are available at www.turboairinc.com.

Actual shipping weight may differ due to extra packing materials for product protection.

* Depth does not include 1-1/4" for rear spacers. † Height does not include 5/8" for bolt height.

WARRANTY: 2 Year Parts and Labor Warranty, 5 Year Compressor Warranty

HORIZONTAL OPEN DISPLAY CASES NATURAL Refrigerant

Self-Cleaning Condenser Equipped Units

■ **Self-Cleaning Condenser (Patented)**

The accumulation of dust in the condenser can cause the failure or breakdown of refrigerators. Refrigerators run normally until they reach a certain level of accumulation. At some point, when they are over the limit, their performance drops quickly resulting in damage to, or disposal of the stored products inside. The Self-Cleaning Condenser device keeps the condenser clean and prevents system failure by automatically brushing daily.

■ **Hydrocarbon refrigerants (R-290)**

With innovative and eco-friendly technology, Turbo Air brings you hydrocarbon refrigerators designed to meet DOE's Energy Conservation Standards in 2017 and to use EPA's SNAP Program approved HC refrigerants. Hydrocarbon refrigerants do not deplete the ozone layer and have very low contribution to global warming (ODP-0, GWP-3).

■ **Modern design**

By integrating great contours with durable structures, our modern style product designs are user-friendly while maintaining the highest product visibility and aesthetics. Safety reinforced tempered glass front shield optimizes the merchandiser's display effects of fresh salads, sandwiches, desserts and beverages. Its elegant contemporary euro design will enhance any store application. Ideal for eye-catching displays and convenient access with fast service in high traffic areas.

■ **Interior materials available in two standards**

SP: stainless steel interior for sanitary purposes.
 SP-A: black coated interior with mirrored sides for maximized display effects.

■ **Solid side panels used to ensure durability**

■ **Standard back-guard improves airflow**

■ **Perforated interior back wall & top for improved airflow**

■ **Foamed with polyurethane, high-density cell insulation (CFC free)**

■ **Front air intake and rear air discharge**

■ **LED interior lighting**



* Please allow extra lead time for solid side panel option.

Self-Cleaning Condenser
 Maintenance-free during warranty period

TOM-50SB-SP-A-N

■ **Standard features**

- Simple plug-in installation
- No plumbing required
- Standard color comes in black only
- Solar powered digital thermometer
- Digital electronic thermostat with defrost control

■ **Optional features**

- Top display dry cases (TOMD-H, L) available in all sizes
- Night cover available
 * Night cover can not be used in conjunction with a TOMD dry case
- Security cover available
- Casters available

- **Recommended operating conditions**

TOM models are designed to operate in an environment where temperature & humidity do not exceed 80°F and 55% respectively. Units should not be installed near HVAC vents, fans or doorways that will disrupt the air curtain and compromise the function of the cabinet. Air curtain models will run most efficiently when completely loaded with product. When used as a built-in, required clearance for the rear is 4" and the top is 5".

TOM-S / TOMD-H MODELS SPECIFICATIONS

ELECTRICAL/DIMENSIONAL DATA	TOM-30SB-SP(-A)-N	TOM-40SB-SP(-A)-N	TOM-50SB-SP(-A)-N	TOM-60SB-SP(-A)-N	TOM-75SB-SP(-A)-N
Voltage	115/60/1	115/60/1	115/60/1	115/60/1	115/60/1
Plug Type	Ⓢ NEMA 5-15P	Ⓢ NEMA 5-15P	Ⓢ NEMA 5-15P	Ⓢ NEMA 5-20P	Ⓢ NEMA 5-20P
Full Load Amp.	7	7.3	7.3	14.7	14.7
Compressor HP	1/3	3/4	3/4	3/4 x 2	3/4 x 2
Refrigerant	R-290	R-290	R-290	R-290	R-290
Net Capacity (cu. ft.)	4.7	6.7	8.9	11.2	13.5
Ext. Dimension (L x D* x H†) (in.)	28 1/8 x 33 1/2 x 41 1/2	39 1/8 x 33 1/2 x 41 1/2	50 7/8 x 33 1/2 x 41 1/2	63 3/8 x 33 1/2 x 41 1/2	75 3/4 x 33 1/2 x 41 1/2
# of Bottom Shelves	3	3	3	3	3
Shelf Size (L x D) (in.)	Top	25 1/2 x 7 1/8	36 1/2 x 7 1/8	48 1/4 x 7 1/8	60 3/4 x 7 1/8
	Middle	25 1/2 x 14 1/8	36 1/2 x 14 1/8	48 1/4 x 14 1/8	60 3/4 x 14 1/8
	Low	25 1/2 x 9 7/8	36 1/2 x 9 7/8	48 1/4 x 9 7/8	60 3/4 x 9 7/8
Net Weight (lbs.)	255	313	370	440	498
Gross Weight (lbs.)	338	440	481	535	680

DIMENSIONAL DATA	TOMD-30HB	TOMD-40HB	TOMD-50HB	TOMD-60HB	TOMD-75HB
Ext. Dimension (L x D x H) (in.)	28 x 12 1/4 x 17 3/4	39 x 12 1/4 x 17 3/4	50 3/4 x 12 1/4 x 17 3/4	63 1/4 x 12 1/4 x 17 3/4	75 5/8 x 12 1/4 x 17 3/4
Net Capacity (cu. ft.)	2.1	3	4	5	6.1
# of Shelves (Size (L x D) (in.))	1 (25 1/2 x 7)	1 (36 1/2 x 7)	1 (48 1/4 x 7)	1 (60 3/4 x 7)	1 (73 1/4 x 7)
Net Weight / Gross Weight (lbs.)	48 / 53	66 / 70	81 / 87	99 / 110	111 / 128

Design and specifications subject to change without notice. Most updated spec sheets are available at www.turboairinc.com.

Actual shipping weight may differ due to extra packing materials for product protection.

* Depth does not include 1-1/4" for rear spacers. † Height does not include 5/8" for bolt height.

■ **WARRANTY: 2 Year Parts and Labor Warranty, 5 Year Compressor Warranty**

HORIZONTAL OPEN DISPLAY CASES NATURAL Refrigerant

Self-Cleaning Condenser Equipped Units

Self-Cleaning Condenser (Patented)

The accumulation of dust in the condenser can cause the failure or breakdown of refrigerators. Refrigerators run normally until they reach a certain level of accumulation. At some point, when they are over the limit, their performance drops quickly resulting in damage to, or disposal of the stored products inside. The Self-Cleaning Condenser device keeps the condenser clean and prevents system failure by automatically brushing daily.

Hydrocarbon refrigerants (R-290)

With innovative and eco-friendly technology, Turbo Air brings you hydrocarbon refrigerators designed to meet DOE's Energy Conservation Standards in 2017 and to use EPA's SNAP Program approved HC refrigerants. Hydrocarbon refrigerants do not deplete the ozone layer and have very low contribution to global warming (ODP-0, GWP-3).

Modern design

By integrating great contours with durable structures, our modern style product designs are user-friendly while maintaining the highest product visibility and aesthetics. Safety reinforced tempered glass front shield and side walls optimize the merchandiser's display effects of fresh salads, sandwiches, desserts and beverages. Its elegant contemporary euro design will enhance any store application. Ideal for eye-catching displays and convenient access with fast service in high traffic areas.

Standard back-guard improves airflow

Stainless steel interior standard including back wall and deck pans

Stainless steel solid shelves standard

Perforated interior back wall & top for improved airflow

Foamed with polyurethane, high-density cell insulation (CFC free)

Front air intake and rear air discharge

Stainless steel color option available

Standard features

- Simple plug-in installation
- No plumbing required
- White and black colors comes standard
- Solar powered digital thermometer
- Digital electronic thermostat with defrost control
- LED interior lighting



TOM-40LS-N
Self-Cleaning Condenser
Maintenance-free during warranty period

TOM-60LW-N & TOMD-60LW

Optional features

- Top display dry cases (TOMD-H, L) available in all sizes
- Night cover available
- * Night cover can not be used in conjunction with a TOMD dry case
- Security cover available
- Price tag channel available
- Leveling leg available
- Casters available

Recommended operating conditions

TOM models are designed to operate in an environment where temperature & humidity do not exceed 80°F and 55% respectively. Units should not be installed near HVAC vents, fans or doorways that will disrupt the air curtain and compromise the function of the cabinet. Air curtain models will run most efficiently when completely loaded with product. When used as a built-in, required clearance for the rear is 4" and the top is 5".

TOM-L / TOMD-L MODELS SPECIFICATIONS

ELECTRICAL/DIMENSIONAL DATA	TOM-30LW(B, S)-N	TOM-40LW(B, S)-N	TOM-50LW(B, S)-N	TOM-60LW(B, S)-N	TOM-75LW(B, S)-N
Voltage	115/60/1	115/60/1	115/60/1	115/60/1	115/60/1
Plug Type	Ⓜ NEMA 5-15P	Ⓜ NEMA 5-15P	Ⓜ NEMA 5-15P	Ⓜ NEMA 5-20P	Ⓜ NEMA 5-20P
Full Load Amp.	7	7.3	7.3	14.7	14.7
Compressor HP	1/3	3/4	3/4	3/4 x 2	3/4 x 2
Refrigerant	R-290	R-290	R-290	R-290	R-290
Net Capacity (cu. ft.)	5.1	7.4	9.8	12.3	14.8
Ext. Dimension (L x D ^o x H [†]) (in.)	28 ¹ / ₈ x 33 ¹ / ₂ x 45 ⁷ / ₈	39 ¹ / ₈ x 33 ¹ / ₂ x 45 ⁷ / ₈	50 ⁷ / ₈ x 33 ¹ / ₂ x 45 ⁷ / ₈	63 ³ / ₈ x 33 ¹ / ₂ x 45 ⁷ / ₈	75 ³ / ₄ x 33 ¹ / ₂ x 45 ⁷ / ₈
# of Shelves	1	1	1	1	2
Shelf Size (L x D) (in.)	25 ¹ / ₂ x 10 ³ / ₄	36 ¹ / ₂ x 10 ³ / ₄	48 ³ / ₈ x 10 ³ / ₄	60 ³ / ₄ x 10 ³ / ₄	36 ¹ / ₂ x 10 ³ / ₄
Net Weight (lbs.)	257	317	376	448	507
Gross Weight (lbs.)	340	450	505	583	710

DIMENSIONAL DATA	TOMD-30LW(B, S)	TOMD-40LW(B, S)	TOMD-50LW(B, S)	TOMD-60LW(B, S)	TOMD-75LW(B, S)
Ext. Dimension (L x D x H) (in.)	28 x 12 ¹ / ₄ x 13 ¹ / ₄	39 x 12 ¹ / ₄ x 13 ¹ / ₄	50 ³ / ₄ x 12 ¹ / ₄ x 13 ¹ / ₄	63 ¹ / ₄ x 12 ¹ / ₄ x 13 ¹ / ₄	75 ⁵ / ₈ x 12 ¹ / ₄ x 13 ¹ / ₄
Net Capacity (cu. ft.)	1.5	2.1	2.9	3.6	4.3
Net Weight / Gross Weight (lbs.)	37 / 38	48 / 51	59 / 65	74 / 80	90 / 95

Design and specifications subject to change without notice. Most updated spec sheets are available at www.turboairinc.com.

Actual shipping weight may differ due to extra packing materials for product protection.

* Depth does not include 1-1/4" for rear spacers. † Height does not include 5/8" for bolt height.

WARRANTY: 2 Year Parts and Labor Warranty, 5 Year Compressor Warranty

HORIZONTAL OPEN DISPLAY CASES NATURAL Refrigerant

Self-Cleaning Condenser Equipped Units

Self-Cleaning Condenser (Patented)

The accumulation of dust in the condenser can cause the failure or breakdown of refrigerators. Refrigerators run normally until they reach a certain level of accumulation. At some point, when they are over the limit, their performance drops quickly resulting in damage to, or disposal of the stored products inside. The Self-Cleaning Condenser device keeps the condenser clean and prevents system failure by automatically brushing daily.

Hydrocarbon refrigerants (R-290)

With innovative and eco-friendly technology, Turbo Air brings you hydrocarbon refrigerators designed to meet DOE's Energy Conservation Standards in 2017 and to use EPA's SNAP Program approved HC refrigerants. Hydrocarbon refrigerants do not deplete the ozone layer and have very low contribution to global warming (ODP-0, GWP-3).

Modern design

By integrating great contours with durable structures, our modern style product designs are user-friendly while maintaining the highest product visibility and aesthetics. Safety reinforced tempered glass front shield optimizes the merchandiser's display effects of fresh salads, sandwiches, desserts and beverages. Its elegant contemporary euro design will enhance any store application. Ideal for eye-catching displays and convenient access with fast service in high traffic areas.

Interior materials available in two standards

SP: stainless steel interior for sanitary purposes.
SP-A: black coated interior with mirrored sides for maximized display effects.

Solid side panels used to ensure durability

Standard back-guard improves airflow

Perforated interior back wall & top for improved airflow

Foamed with polyurethane, high-density cell insulation (CFC free)

Front air intake and rear air discharge

LED interior lighting



Self-Cleaning Condenser
Maintenance-free
during warranty period

TOM-50LB-SP-A-N

* Please allow extra lead time for solid side panel option.

Standard features

- Simple plug-in installation
- No plumbing required
- Standard color comes in black only
- Solar powered digital thermometer
- Digital electronic thermostat with defrost control

Optional features

- Top display dry cases (TOMD-H, L) available in all sizes
- Night cover available
* Night cover can not be used in conjunction with a TOMD dry case
- Security cover available
- Price tag channel available
- Casters available

Recommended operating conditions

TOM models are designed to operate in an environment where temperature & humidity do not exceed 80°F and 55% respectively. Units should not be installed near HVAC vents, fans or doorways that will disrupt the air curtain and compromise the function of the cabinet. Air curtain models will run most efficiently when completely loaded with product. When used as a built-in, required clearance for the rear is 4" and the top is 5".

TOM-L / TOMD-L MODELS SPECIFICATIONS

ELECTRICAL/DIMENSIONAL DATA	TOM-30LB-SP(-A)-N	TOM-40LB-SP(-A)-N	TOM-50LB-SP(-A)-N	TOM-60LB-SP(-A)-N	TOM-75LB-SP(-A)-N
Voltage	115/60/1	115/60/1	115/60/1	115/60/1	115/60/1
Plug Type	Ⓜ NEMA 5-15P	Ⓜ NEMA 5-15P	Ⓜ NEMA 5-15P	Ⓜ NEMA 5-20P	Ⓜ NEMA 5-20P
Full Load Amp.	7	7.3	7.3	14.7	14.7
Compressor HP	1/3	3/4	3/4	3/4 x 2	3/4 x 2
Refrigerant	R-290	R-290	R-290	R-290	R-290
Net Capacity (cu. ft.)	5.1	7.4	9.8	12.3	14.8
Ext. Dimension (L x D x H†) (in.)	28 1/8 x 33 1/2 x 45 7/8	39 1/8 x 33 1/2 x 45 7/8	50 7/8 x 33 1/2 x 45 7/8	63 3/8 x 33 1/2 x 45 7/8	75 3/4 x 33 1/2 x 45 7/8
# of Shelves	1	1	1	1	2
Shelf Size (L x D) (in.)	25 1/2 x 10 3/4	36 1/2 x 10 3/4	48 3/8 x 10 3/4	60 3/4 x 10 3/4	36 1/2 x 10 3/4
Net Weight (lbs.)	257	317	376	448	507
Gross Weight (lbs.)	340	450	505	583	710
DIMENSIONAL DATA	TOMD-30LB	TOMD-40LB	TOMD-50LB	TOMD-60LB	TOMD-75LB
Ext. Dimension (L x D x H) (in.)	28 x 12 1/4 x 13 1/4	39 x 12 1/4 x 13 1/4	50 3/4 x 12 1/4 x 13 1/4	63 1/4 x 12 1/4 x 13 1/4	75 5/8 x 12 1/4 x 13 1/4
Net Capacity (cu. ft.)	1.5	2.1	2.9	3.6	4.3
Net Weight / Gross Weight (lbs.)	37 / 38	48 / 51	59 / 65	74 / 80	90 / 95

Design and specifications subject to change without notice. Most updated spec sheets are available at www.turboairinc.com.

Actual shipping weight may differ due to extra packing materials for product protection.

* Depth does not include 1-1/4" for rear spacers. † Height does not include 5/8" for bolt height.

■ **WARRANTY: 2 Year Parts and Labor Warranty, 5 Year Compressor Warranty**

HORIZONTAL OPEN DISPLAY CASES NATURAL Refrigerant

■ **Hydrocarbon refrigerants (R-290)**

With innovative and eco-friendly technology, Turbo Air brings you hydrocarbon refrigerators designed to meet DOE's Energy Conservation Standards in 2017 and to use EPA's SNAP Program approved HC refrigerants. Hydrocarbon refrigerants do not deplete the ozone layer and have very low contribution to global warming (ODP-0, GWP-3).

■ **Digital temperature controller**

■ **LED interior lighting under each shelf**

■ **Adjustable, tempered glass shelves standard (Cantilever type)**

■ **Modern design**

Exterior top and bottom have a mirror finish with glass side walls. Bottom side panels foamed with polyurethane, high-density cell insulation (CFC free).

■ **Bottom glass shelf and stainless steel back wall with a mirror finish**

■ **Standard back-guard improves airflow**

■ **Foamed with polyurethane, high-density cell insulation (CFC free)**

■ **Perforated interior back wall and top for improved airflow**

■ **Front air intake and rear air discharge**

■ **Standard features**

- Simple plug-in installation
- No plumbing required
- White and black colors come standard
- Digital electronic thermostat with defrost control
- Energy saving night curtain
- 3" dia. swivel casters with locks on the front set
- Lead time applies

■ **Optional features**

- Price tag channel available

- **Recommended operating conditions**

TBA models are designed to operate in an environment where temperature & humidity do not exceed 80°F and 55% respectively. Units should not be installed near HVAC vents, fans or doorways that will disrupt the air curtain and compromise the function of the cabinet. Air curtain models will run most efficiently when completely loaded with product. When used as a built-in, required clearance for the rear is 4" and the top is 5".



TBA37-50N-W



TBA49-50N-B

TBA MODELS SPECIFICATIONS

ELECTRICAL DATA	TBA37-50N-W(B)	TBA49-50N-W(B)
Voltage	115/60/1	115/60/1
Plug Type	Ⓢ NEMA 5-15P	Ⓢ NEMA 5-20P
Full Load Amp.	8.82	12.12
Compressor HP	7/8	3/4
Refrigerant	R-290	R-290
DIMENSIONAL DATA		
Net Capacity (cu. ft.)	4.2	5.7
Ext. Dimension (L x D x H*) (in.)	37 x 28 x 49 1/4	48 7/8 x 28 x 49 1/4
# of Shelves	2	2
Shelf Size (L x D) (in.)	32 3/8 x 8 3/4, 32 3/8 x 12 5/8	44 1/8 x 8 3/4, 44 1/8 x 12 5/8
Net Weight (lbs.)	300	360
Gross Weight (lbs.)	450	550

Design and specifications subject to change without notice. Most updated spec sheets are available at www.turboairinc.com.

Actual shipping weight may differ due to extra packing materials for product protection.

* Height does not include 2-1/2" for caster height.

■ **WARRANTY: 2 Year Parts and Labor Warranty, 5 Year Compressor Warranty**

COMBINATION DISPLAY CASES NATURAL Refrigerant

Self-Cleaning Condenser Equipped Units

■ **Self-Cleaning Condenser (Patented)**

The accumulation of dust in the condenser can cause the failure or breakdown of refrigerators. Refrigerators run normally until they reach a certain level of accumulation. At some point, when they are over the limit, their performance drops quickly resulting in damage to, or disposal of the stored products inside. The Self-Cleaning Condenser device keeps the condenser clean and prevents system failure by automatically brushing daily.

■ **Hydrocarbon refrigerants (R-290)**

With innovative and eco-friendly technology, Turbo Air brings you hydrocarbon refrigerators designed to meet DOE's Energy Conservation Standards in 2017 and to use EPA's SNAP Program approved HC refrigerants. Hydrocarbon refrigerants do not deplete the ozone layer and have very low contribution to global warming (ODP-0, GWP-3).

■ **Modern design**

By integrating great contours with durable structures, our modern style product designs are user-friendly while maintaining the highest product visibility and aesthetics. Safety reinforced tempered glass front shield and top display case optimize the merchandiser's display effects of fresh salads, sandwiches, desserts and beverages. Its elegant contemporary euro design will enhance any store application.

■ **Designed to enhance impulsive sales**

Ideal for eye-catching displays and convenient access with fast service in high traffic area.

■ **Stainless steel interior standard including back wall and deck pans**

■ **Stainless steel solid shelves standard**

■ **Standard back-guard improves airflow**

■ **Foamed with polyurethane, high-density cell insulation (CFC Free)**

■ **Perforated interior back wall and top for improved airflow**

■ **Front air intake and rear air discharge**



Self-Cleaning Condenser
Maintenance-free during warranty period

TOM-W-50SB-N

■ **Standard features**

- Simple plug-in installation
- No plumbing required
- Standard color comes in black only
- Solar powered digital thermometer
- Digital electronic thermostat with defrost control
- LED interior lighting

■ **Optional features**

- Price tag channel available
- White color option available (Please allow 8 weeks lead time)

- **Recommended operating conditions**

TOM models are designed to operate in an environment where temperature & humidity do not exceed 80°F and 55% respectively. Units should not be installed near HVAC vents, fans or doorways that will disrupt the air curtain and compromise the function of the cabinet. Air curtain models will run most efficiently when completely loaded with product. When used as a built-in, required clearance for the rear is 4" and the top is 5".

TOM-W MODELS SPECIFICATIONS

ELECTRICAL DATA		TOM-W-40SB-N	TOM-W-50SB-N	TOM-W-60SB-N
Voltage		115/60/1	115/60/1	115/60/1
Plug Type		Ⓜ NEMA 5-15P	Ⓜ NEMA 5-15P	Ⓜ NEMA 5-20P
Full Load Amp.		7.3	7.3	14.7
Compressor HP		3/4	3/4	3/4 x 2
Refrigerant		R-290	R-290	R-290
DIMENSIONAL DATA				
Net Capacity (Top / Bottom) (cu. ft.)		4.2 / 6.4	5.6 / 8.5	7.0 / 10.7
Ext. Dimension (L x D x H*) (in.)		38 7/8 x 34 1/8 x 56 3/8	50 7/8 x 34 1/8 x 56 3/8	62 5/8 x 34 1/8 x 56 3/8
Interior Dimensions (L x D x H) (in.)	Top	35 5/8 x 13 x 15 3/4	47 5/8 x 13 x 15 3/4	59 1/2 x 13 x 15 3/4
	Bottom	35 5/8 x 24 x 13 7/8	47 5/8 x 24 x 13 7/8	59 1/2 x 24 x 13 7/8
Shelf Size (L x D) (in.)	Top	34 3/8 x 10 3/4	46 3/8 x 10 3/4	58 1/4 x 10 3/4
	Bottom	35 5/8 x 9 7/8	47 1/2 x 9 7/8	59 3/8 x 9 7/8
Net Weight (lbs.)		425	496	567
Gross Weight (lbs.)		535	639	730

Design and specifications subject to change without notice. Most updated spec sheets are available at www.turboairinc.com.

Actual shipping weight may differ due to extra packing materials for product protection.

* Height does not include 5/8" for bolt height.

■ **WARRANTY: 2 Year Parts and Labor Warranty, 5 Year Compressor Warranty**

COMBINATION DISPLAY CASES NATURAL Refrigerant

Self-Cleaning Condenser Equipped Units

Self-Cleaning Condenser (Patented)

The accumulation of dust in the condenser can cause the failure or breakdown of refrigerators. Refrigerators run normally until they reach a certain level of accumulation. At some point, when they are over the limit, their performance drops quickly resulting in damage to, or disposal of the stored products inside. The Self-Cleaning Condenser device keeps the condenser clean and prevents system failure by automatically brushing daily.

Hydrocarbon refrigerants (R-290)

With innovative and eco-friendly technology, Turbo Air brings you hydrocarbon refrigerators designed to meet DOE's Energy Conservation Standards in 2017 and to use EPA's SNAP Program approved HC refrigerants. Hydrocarbon refrigerants do not deplete the ozone layer and have very low contribution to global warming (ODP-0, GWP-3).

Modern design

By integrating great contours with durable structures, our modern style product designs are user-friendly while maintaining the highest product visibility and aesthetics. Safety reinforced tempered glass front shield and side walls optimize the merchandiser's display effects of fresh salads, sandwiches, desserts and beverages. Its elegant contemporary euro design will enhance any store application.

Designed to enhance impulsive sales

Ideal for eye-catching displays and convenient access with fast service in high traffic area.

Stainless steel interior standard including back wall and deck pans

Stainless steel solid shelves standard

Standard back-guard improves airflow

Foamed with polyurethane, high-density cell insulation (CFC Free)

Perforated interior back wall and top for improved airflow

Front air intake and rear air discharge



Self-Cleaning Condenser
Maintenance-free
during warranty period

TOM-W-50SB-UF-N

Standard features

- Simple plug-in installation
- No plumbing required
- Standard color comes in black only
- Solar powered digital thermometer
- Digital electronic thermostat with defrost control
- LED interior lighting

Optional features

- Price tag channel available
- White color option available (Please allow 8 weeks lead time)

Recommended operating conditions

TOM models are designed to operate in an environment where temperature & humidity do not exceed 80°F and 55% respectively. Units should not be installed near HVAC vents, fans or doorways that will disrupt the air curtain and compromise the function of the cabinet. Air curtain models will run most efficiently when completely loaded with product. When used as a built-in, required clearance for the rear is 4" and the top is 5".

TOM-W MODELS SPECIFICATIONS

ELECTRICAL DATA		TOM-W-40SB-UF-N	TOM-W-50SB-UF-N	TOM-W-60SB-UF-N
Voltage		115/60/1	115/60/1	115/60/1
Plug Type		Ⓜ NEMA 5-15P	Ⓜ NEMA 5-15P	Ⓜ NEMA 5-20P
Full Load Amp.		7.3	7.3	14.7
Compressor HP		3/4	3/4	3/4 x 2
Refrigerant		R-290	R-290	R-290
DIMENSIONAL DATA				
Net Capacity (Top / Bottom) (cu. ft.)		4.2 / 6.4	5.6 / 8.5	7.0 / 10.7
Ext. Dimension (L x D x H*) (in.)		38 ⁷ / ₈ x 34 ¹ / ₈ x 56 ³ / ₄	50 ⁷ / ₈ x 34 ¹ / ₈ x 56 ³ / ₄	62 ⁵ / ₈ x 34 ¹ / ₈ x 56 ³ / ₄
Interior Dimensions (L x D x H) (in.)	Top	35 ⁵ / ₈ x 13 x 15 ³ / ₄	47 ⁵ / ₈ x 13 x 15 ³ / ₄	59 ¹ / ₂ x 13 x 15 ³ / ₄
	Bottom	35 ⁵ / ₈ x 24 x 13 ⁷ / ₈	47 ⁵ / ₈ x 24 x 13 ⁷ / ₈	59 ¹ / ₂ x 24 x 13 ⁷ / ₈
Shelf Size (L x D) (in.)	Top	34 ³ / ₈ x 10 ³ / ₄	46 ³ / ₈ x 10 ³ / ₄	58 ¹ / ₄ x 10 ³ / ₄
	Bottom	35 ⁵ / ₈ x 9 ⁷ / ₈	47 ¹ / ₂ x 9 ⁷ / ₈	59 ³ / ₈ x 9 ⁷ / ₈
Net Weight (lbs.)		425	496	567
Gross Weight (lbs.)		535	639	730

Design and specifications subject to change without notice. Most updated spec sheets are available at www.turboairinc.com.

Actual shipping weight may differ due to extra packing materials for product protection.

* Height does not include 5/8" for bolt height.

WARRANTY: 2 Year Parts and Labor Warranty, 5 Year Compressor Warranty

HORIZONTAL OPEN DISPLAY CASES NATURAL Refrigerant

Self-Cleaning Condenser Equipped Units



Self-Cleaning Condenser
Maintenance-free during warranty period **TOM-48L-UF-W-3S-N**

■ **Self-Cleaning Condenser (Patented)**

The accumulation of dust in the condenser can cause the failure or breakdown of refrigerators. Refrigerators run normally until they reach a certain level of accumulation. At some point, when they are over the limit, their performance drops quickly resulting in damage to, or disposal of the stored products inside. The Self-Cleaning Condenser device keeps the condenser clean and prevents system failure by automatically brushing daily.

■ **Hydrocarbon refrigerants (R-290)**

With innovative and eco-friendly technology, Turbo Air brings you hydrocarbon refrigerators designed to meet DOE's Energy Conservation Standards in 2017 and to use EPA's SNAP Program approved HC refrigerants. Hydrocarbon refrigerants do not deplete the ozone layer and have very low contribution to global warming (ODP-0, GWP-3).

■ **Modern design**

By integrating great contours with durable structures, our modern style product designs are user-friendly while maintaining the highest product visibility and aesthetics. Safety reinforced tempered glass front shield and side walls optimize the merchandiser's display effects of fresh salads, sandwiches, desserts and beverages. Its elegant contemporary euro design will enhance any store application.

■ **Standard back-guard improves airflow**

■ **Stainless steel interior standard including back wall and deck pans**

■ **Bottom stainless steel solid shelf and glass shelves standard**

■ **Perforated interior back wall & top for improved airflow**

■ **Foamed with polyurethane, high-density cell insulation (CFC free)**

■ **LED interior lighting**

■ **Front air intake and rear air discharge**

■ **Stainless steel color option available**

■ **Standard features**

- Simple plug-in installation
- No plumbing required
- White and black colors come standard
- Solar powered digital thermometer
- Digital electronic thermostat with defrost control
- Energy saving night curtain
- Lead time applies

■ **Optional features**

- Casters available
- Leveling leg available

- **Recommended operating conditions**

TOM models are designed to operate in an environment where temperature & humidity do not exceed 80°F and 55% respectively. Units should not be installed near HVAC vents, fans or doorways that will disrupt the air curtain and compromise the function of the cabinet. Air curtain models will run most efficiently when completely loaded with product. When used as a built-in, required clearance for the rear is 4" and the top is 5".

TOM-L-UF MODELS SPECIFICATIONS

ELECTRICAL/DIMENSIONAL DATA	TOM-36L-UF-W(B, S)-1S-N	TOM-36L-UF-W(B, S)-2S-N	TOM-36L-UF-W(B, S)-3S-N
Voltage	115/60/1	115/60/1	115/60/1
Plug Type	☺ NEMA 5-20P	☺ NEMA 5-20P	☺ NEMA 5-20P
Full Load Amp.	11.3	11.3	11.3
Compressor HP	3/4 x 2	3/4 x 2	3/4 x 2
Refrigerant	R-290	R-290	R-290
Net Capacity (cu. ft.)	4.6	7.5	11.1
Ext. Dimension (L x D x H*) (in.)	34 ³ / ₄ x 33 x 37 ³ / ₄	34 ³ / ₄ x 33 x 44 ¹ / ₄	34 ³ / ₄ x 33 x 52 ¹ / ₂
# of Shelves (Size (L x D) (in.))	-	1 (31 ⁵ / ₈ x 14)	2 (31 ⁵ / ₈ x 10, 31 ⁵ / ₈ x 14)
Net / Gross Weight (lbs.)	335 / 412	368 / 447	401 / 482

ELECTRICAL/DIMENSIONAL DATA	TOM-48L-UF-W(B, S)-1S-N	TOM-48L-UF-W(B, S)-2S-N	TOM-48L-UF-W(B, S)-3S-N
Voltage	115/60/1	115/60/1	115/60/1
Plug Type	☺ NEMA 5-20P	☺ NEMA 5-20P	☺ NEMA 5-20P
Full Load Amp.	13.6	13.6	13.6
Compressor HP	3/4 x 2	3/4 x 2	3/4 x 2
Refrigerant	R-290	R-290	R-290
Net Capacity (cu. ft.)	6.3	10.2	15.2
Ext. Dimension (L x D x H*) (in.)	46 ³ / ₄ x 33 x 37 ³ / ₄	46 ³ / ₄ x 33 x 44 ¹ / ₄	46 ³ / ₄ x 33 x 52 ¹ / ₂
# of Shelves (Size (L x D) (in.))	-	1 (43 ⁵ / ₈ x 14)	2 (43 ⁵ / ₈ x 10, 43 ⁵ / ₈ x 14)
Net / Gross Weight (lbs.)	416 / 504	438 / 528	462 / 550

Design and specifications subject to change without notice. Most updated spec sheets are available at www.turboairinc.com.

Actual shipping weight may differ due to extra packing materials for product protection.

* Height does not include 5/8" for bolt height.

■ **WARRANTY: 2 Year Parts and Labor Warranty, 5 Year Compressor Warranty**

HORIZONTAL OPEN DISPLAY CASES NATURAL Refrigerant

Self-Cleaning Condenser Equipped Units

Self-Cleaning Condenser (Patented)

The accumulation of dust in the condenser can cause the failure or breakdown of refrigerators. Refrigerators run normally until they reach a certain level of accumulation. At some point, when they are over the limit, their performance drops quickly resulting in damage to, or disposal of the stored products inside. The Self-Cleaning Condenser device keeps the condenser clean and prevents system failure by automatically brushing daily.

Hydrocarbon refrigerants (R-290)

With innovative and eco-friendly technology, Turbo Air brings you hydrocarbon refrigerators designed to meet DOE's Energy Conservation Standards in 2017 and to use EPA's SNAP Program approved HC refrigerants. Hydrocarbon refrigerants do not deplete the ozone layer and have very low contribution to global warming (ODP-0, GWP-3).

Modern design

By integrating great contours with durable structures, our modern style product designs are user-friendly while maintaining the highest product visibility and aesthetics. Safety reinforced tempered glass front shield and side walls optimize the merchandiser's display effects of fresh salads, sandwiches, desserts and beverages. Its elegant contemporary euro design will enhance any store application.

Standard back-guard improves airflow

Stainless steel interior standard including back wall and deck pans

Bottom stainless steel solid shelf and glass shelves standard

Perforated interior back wall & top for improved airflow

Foamed with polyurethane, high-density cell insulation (CFC free)

LED interior lighting

Front air intake and rear air discharge

Stainless steel color option available



Self-Cleaning Condenser
Maintenance-free during warranty period **TOM-60L-UF-B-2S-N**

Standard features

- Simple plug-in installation
- No plumbing required
- White and black colors come standard
- Solar powered digital thermometer
- Digital electronic thermostat with defrost control
- Energy saving night curtain
- Lead time applies

Optional features

- Casters available
- Leveling leg available

Recommended operating conditions

TOM models are designed to operate in an environment where temperature & humidity do not exceed 80°F and 55% respectively. Units should not be installed near HVAC vents, fans or doorways that will disrupt the air curtain and compromise the function of the cabinet. Air curtain models will run most efficiently when completely loaded with product. When used as a built-in, required clearance for the rear is 4" and the top is 5".

TOM-L-UF MODELS SPECIFICATIONS

ELECTRICAL/DIMENSIONAL DATA	TOM-60L-UF-W(B, S)-1S-N	TOM-60L-UF-W(B, S)-2S-N	TOM-60L-UF-W(B, S)-3S-N
Voltage	115/60/1	115/60/1	115/60/1
Plug Type	Ⓢ NEMA 5-20P	Ⓢ NEMA 5-20P	Ⓢ NEMA 5-20P
Full Load Amp.	15.0	15.0	15.0
Compressor HP	3/4 x 2	3/4 x 2	3/4 x 2
Refrigerant	R-290	R-290	R-290
Net Capacity (cu. ft.)	8.0	13.0	19.3
Ext. Dimension (L x D x H*) (in.)	58 ³ / ₄ x 33 x 37 ³ / ₄	58 ³ / ₄ x 33 x 44 ¹ / ₄	58 ³ / ₄ x 33 x 52 ¹ / ₂
# of Shelves (Size (L x D) (in.))	-	1 (55 ⁵ / ₈ x 14)	2 (55 ⁵ / ₈ x 10, 55 ⁵ / ₈ x 14)
Net / Gross Weight (lbs.)	449 / 548	482 / 584	526 / 631

ELECTRICAL/DIMENSIONAL DATA	TOM-72L-UF-W(B, S)-1S-N	TOM-72L-UF-W(B, S)-2S-N	TOM-72L-UF-W(B, S)-3S-N
Voltage	220/60/1	220/60/1	220/60/1
Plug Type	Ⓢ NEMA 6-20P	Ⓢ NEMA 6-20P	Ⓢ NEMA 6-20P
Full Load Amp.	13.0	13.0	13.0
Compressor HP	3/4 x 4	3/4 x 4	3/4 x 4
Refrigerant	R-290	R-290	R-290
Net Capacity (cu. ft.)	9.7	15.8	23.4
Ext. Dimension (L x D x H*) (in.)	70 ³ / ₄ x 33 x 37 ³ / ₄	70 ³ / ₄ x 33 x 44 ¹ / ₄	70 ³ / ₄ x 33 x 52 ¹ / ₂
# of Shelves (Size (L x D) (in.))	-	2 (33 ¹ / ₂ x 14)	2 (33 ¹ / ₂ x 10), 2 (33 ¹ / ₂ x 14)
Net / Gross Weight (lbs.)	659 / 769	690 / 805	734 / 854

Design and specifications subject to change without notice. Most updated spec sheets are available at www.turboairinc.com.

Actual shipping weight may differ due to extra packing materials for product protection.

* Height does not include 5/8" for bolt height.

WARRANTY: 2 Year Parts and Labor Warranty, 5 Year Compressor Warranty

HORIZONTAL OPEN DISPLAY CASES NATURAL Refrigerant

Self-Cleaning Condenser Equipped Units

■ **Self-Cleaning Condenser (Patented)**

The accumulation of dust in the condenser can cause the failure or breakdown of refrigerators. Refrigerators run normally until they reach a certain level of accumulation. At some point, when they are over the limit, their performance drops quickly resulting in damage to, or disposal of the stored products inside. The Self-Cleaning Condenser device keeps the condenser clean and prevents system failure by automatically brushing daily.

■ **Hydrocarbon refrigerants (R-290)**

With innovative and eco-friendly technology, Turbo Air brings you hydrocarbon refrigerators designed to meet DOE's Energy Conservation Standards in 2017 and to use EPA's SNAP Program approved HC refrigerants. Hydrocarbon refrigerants do not deplete the ozone layer and have very low contribution to global warming (ODP-0, GWP-3).

■ **Modern design**

By integrating great contours with durable structures, our modern style product designs are user-friendly while maintaining the highest product visibility and aesthetics. Safety reinforced tempered glass front shield and side walls optimize the merchandiser's display effects of fresh salads, sandwiches, desserts and beverages. Its elegant contemporary euro design will enhance any store application.

■ **Standard back-guard improves airflow**

■ **Bottom stainless steel solid shelf and glass shelves standard**

■ **Perforated glass doors & open top for improved airflow**

■ **Foamed with polyurethane, high-density cell insulation (CFC free)**

■ **LED interior lighting**

■ **Front air intake and rear air discharge**

■ **Sliding rear door for product loading & unloading**

■ **Stainless steel color option available**



Self-Cleaning Condenser
Maintenance-free during warranty period
TOM-36L-UFD-S-2S-N

TOM-48L-UFD-B-3S-N

■ **Standard features**

- Simple plug-in installation
- No plumbing required
- White and black colors come standard
- Solar powered digital thermometer
- Digital electronic thermostat with defrost control
- Energy saving night curtain
- Lead time applies

■ **Optional features**

- Casters available
- Leveling leg available

- **Recommended operating conditions**

TOM models are designed to operate in an environment where temperature & humidity do not exceed 80°F and 55% respectively. Units should not be installed near HVAC vents, fans or doorways that will disrupt the air curtain and compromise the function of the cabinet. Air curtain models will run most efficiently when completely loaded with product. When used as a built-in, required clearance for the rear is 4" and the top is 5".

TOM-L-UFD MODELS SPECIFICATIONS

ELECTRICAL/DIMENSIONAL DATA	TOM-36L-UFD-W(B, S)-1S-N	TOM-36L-UFD-W(B, S)-2S-N	TOM-36L-UFD-W(B, S)-3S-N
Voltage	115/60/1	115/60/1	115/60/1
Plug Type	☺ NEMA 5-20P	☺ NEMA 5-20P	☺ NEMA 5-20P
Full Load Amp.	11.3	11.3	11.3
Compressor HP	3/4 x 2	3/4 x 2	3/4 x 2
Refrigerant	R-290	R-290	R-290
Net Capacity (cu. ft.)	4.6	7.5	11.1
Ext. Dimension (L x D x H*) (in.)	34 3/4 x 33 3/4 x 37 3/4	34 3/4 x 33 3/4 x 44 1/4	34 3/4 x 33 3/4 x 52 1/2
# of Shelves (Size (L x D) (in.))	-	1 (31 5/8 x 14)	2 (31 5/8 x 10, 31 5/8 x 14)
Net / Gross Weight (lbs.)	344 / 421	382 / 461	418 / 499

ELECTRICAL/DIMENSIONAL DATA	TOM-48L-UFD-W(B, S)-1S-N	TOM-48L-UFD-W(B, S)-2S-N	TOM-48L-UFD-W(B, S)-3S-N
Voltage	115/60/1	115/60/1	115/60/1
Plug Type	☺ NEMA 5-20P	☺ NEMA 5-20P	☺ NEMA 5-20P
Full Load Amp.	13.6	13.6	13.6
Compressor HP	3/4 x 2	3/4 x 2	3/4 x 2
Refrigerant	R-290	R-290	R-290
Net Capacity (cu. ft.)	6.3	10.2	15.2
Ext. Dimension (L x D x H*) (in.)	46 3/4 x 33 3/4 x 37 3/4	46 3/4 x 33 3/4 x 44 1/4	46 3/4 x 33 3/4 x 52 1/2
# of Shelves (Size (L x D) (in.))	-	1 (43 5/8 x 14)	2 (43 5/8 x 10, 43 5/8 x 14)
Net / Gross Weight (lbs.)	432 / 520	457 / 547	486 / 574

Design and specifications subject to change without notice. Most updated spec sheets are available at www.turboairinc.com.

Actual shipping weight may differ due to extra packing materials for product protection.

* Height does not include 5/8" for bolt height.

■ **WARRANTY: 2 Year Parts and Labor Warranty, 5 Year Compressor Warranty**

HORIZONTAL OPEN DISPLAY CASES NATURAL Refrigerant

Self-Cleaning Condenser Equipped Units

Self-Cleaning Condenser (Patented)

The accumulation of dust in the condenser can cause the failure or breakdown of refrigerators. Refrigerators run normally until they reach a certain level of accumulation. At some point, when they are over the limit, their performance drops quickly resulting in damage to, or disposal of the stored products inside. The Self-Cleaning Condenser device keeps the condenser clean and prevents system failure by automatically brushing daily.

Hydrocarbon refrigerants (R-290)

With innovative and eco-friendly technology, Turbo Air brings you hydrocarbon refrigerators designed to meet DOE's Energy Conservation Standards in 2017 and to use EPA's SNAP Program approved HC refrigerants. Hydrocarbon refrigerants do not deplete the ozone layer and have very low contribution to global warming (ODP-0, GWP-3).

Modern design

By integrating great contours with durable structures, our modern style product designs are user-friendly while maintaining the highest product visibility and aesthetics. Safety reinforced tempered glass front shield and side walls optimize the merchandiser's display effects of fresh salads, sandwiches, desserts and beverages. Its elegant contemporary euro design will enhance any store application.

Standard back-guard improves airflow

Bottom stainless steel solid shelf and glass shelves standard

Perforated glass doors & open top for improved airflow

Foamed with polyurethane, high-density cell insulation (CFC free)

LED interior lighting

Front air intake and rear air discharge

Sliding rear door for product loading & unloading

Stainless steel color option available



Self-Cleaning Condenser
Maintenance-free
during warranty period

TOM-60L-UFD-W-2S-N

Standard features

- Simple plug-in installation
- No plumbing required
- White and black colors come standard
- Solar powered digital thermometer
- Digital electronic thermostat with defrost control
- Energy saving night curtain
- Lead time applies

Optional features

- Casters available
- Leveling leg available

Recommended operating conditions

TOM models are designed to operate in an environment where temperature & humidity do not exceed 80°F and 55% respectively. Units should not be installed near HVAC vents, fans or doorways that will disrupt the air curtain and compromise the function of the cabinet. Air curtain models will run most efficiently when completely loaded with product. When used as a built-in, required clearance for the rear is 4" and the top is 5".

TOM-L-UFD MODELS SPECIFICATIONS

ELECTRICAL/DIMENSIONAL DATA	TOM-60L-UFD-W(B, S)-1S-N	TOM-60L-UFD-W(B, S)-2S-N	TOM-60L-UFD-W(B, S)-3S-N
Voltage	115/60/1	115/60/1	115/60/1
Plug Type	Ⓢ NEMA 5-20P	Ⓢ NEMA 5-20P	Ⓢ NEMA 5-20P
Full Load Amp.	15.0	15.0	15.0
Compressor HP	3/4 x 2	3/4 x 2	3/4 x 2
Refrigerant	R-290	R-290	R-290
Net Capacity (cu. ft.)	8.0	13.0	19.3
Ext. Dimension (L x D x H*) (in.)	58 ³ / ₄ x 33 ³ / ₄ x 37 ³ / ₄	58 ³ / ₄ x 33 ³ / ₄ x 44 ¹ / ₄	58 ³ / ₄ x 33 ³ / ₄ x 52 ¹ / ₂
# of Shelves (Size (L x D) (in.))	-	1 (55 ⁵ / ₈ x 14)	2 (55 ⁵ / ₈ x 10, 55 ⁵ / ₈ x 14)
Net / Gross Weight (lbs.)	467 / 566	504 / 606	556 / 661

ELECTRICAL/DIMENSIONAL DATA	TOM-72L-UFD-W(B, S)-1S-N	TOM-72L-UFD-W(B, S)-2S-N	TOM-72L-UFD-W(B, S)-3S-N
Voltage	220/60/1	220/60/1	220/60/1
Plug Type	Ⓢ NEMA 6-20P	Ⓢ NEMA 6-20P	Ⓢ NEMA 6-20P
Full Load Amp.	13.0	13.0	13.0
Compressor HP	3/4 x 4	3/4 x 4	3/4 x 4
Refrigerant	R-290	R-290	R-290
Net Capacity (cu. ft.)	9.7	15.8	23.4
Ext. Dimension (L x D x H*) (in.)	70 ³ / ₄ x 33 ³ / ₄ x 37 ³ / ₄	70 ³ / ₄ x 33 ³ / ₄ x 44 ¹ / ₄	70 ³ / ₄ x 33 ³ / ₄ x 52 ¹ / ₂
# of Shelves (Size (L x D) (in.))	-	2 (33 ¹ / ₂ x 14)	2 (33 ¹ / ₂ x 10), 2 (33 ¹ / ₂ x 14)
Net / Gross Weight (lbs.)	683 / 793	720 / 835	773 / 893

Design and specifications subject to change without notice. Most updated spec sheets are available at www.turboairinc.com.

Actual shipping weight may differ due to extra packing materials for product protection.

* Height does not include 5/8" for bolt height.

WARRANTY: 2 Year Parts and Labor Warranty, 5 Year Compressor Warranty

DROP-IN TYPE HORIZONTAL OPEN DISPLAY CASES

Self-Cleaning Condenser Equipped Units

■ **Self-Cleaning Condenser (Patented)**

The accumulation of dust in the condenser can cause the failure or breakdown of refrigerators. Refrigerators run normally until they reach a certain level of accumulation. At some point, when they are over the limit, their performance drops quickly resulting in damage to, or disposal of the stored products inside. The Self-Cleaning Condenser device keeps the condenser clean and prevents system failure by automatically brushing daily.

■ **Hydrocarbon refrigerants (R-290)**

With innovative and eco-friendly technology, Turbo Air brings you hydrocarbon refrigerators designed to meet DOE's Energy Conservation Standards in 2017 and to use EPA's SNAP Program approved HC refrigerants. Hydrocarbon refrigerants do not deplete the ozone layer and have very low contribution to global warming (ODP-0, GWP-3).

■ **Modern design**

By integrating great contours with durable structures, our modern style product designs are user-friendly while maintaining the highest product visibility and aesthetics. Safety reinforced tempered glass front shield and side walls optimize the merchandiser's display effects of fresh salads, sandwiches, desserts and beverages. Its elegant contemporary euro design will enhance any store application.

■ **Standard back-guard improves airflow**

■ **Stainless steel interior standard including back wall and deck pans**

■ **Bottom stainless steel solid shelf and glass shelves standard**

■ **Perforated interior back wall & top for improved airflow**

■ **Foamed with polyurethane, high-density cell insulation (CFC free)**

■ **LED interior lighting**

■ **Front air intake and rear air discharge**

■ **Stainless steel color option available**



■ **Standard features**

- Simple plug-in installation
- No plumbing required
- White and black colors come standard
- Solar powered digital thermometer
- Digital electronic thermostat with defrost control
- Energy saving night curtain
- Lead time applies

- **Recommended operating conditions**

TOM models are designed to operate in an environment where temperature & humidity do not exceed 80°F and 55% respectively. Units should not be installed near HVAC vents, fans or doorways that will disrupt the air curtain and compromise the function of the cabinet. Air curtain models will run most efficiently when completely loaded with product. When used as a built-in, required clearance for the rear is 4" and the top is 5".

TOM-L-UF MODELS SPECIFICATIONS

ELECTRICAL/DIMENSIONAL DATA	TOM-36L-UF-W(B, S)-1SI-N	TOM-36L-UF-W(B, S)-2SI-N	TOM-36L-UF-W(B, S)-3SI-N
Voltage	115/60/1	115/60/1	115/60/1
Plug Type	☺ NEMA 5-20P	☺ NEMA 5-20P	☺ NEMA 5-20P
Full Load Amp.	11.3	11.3	11.3
Compressor HP	3/4 x 2	3/4 x 2	3/4 x 2
Refrigerant	R-290	R-290	R-290
Net Capacity (cu. ft.)	4.6	7.5	11.1
Ext. Dimension (L x D x H*) (in.)	35 7/8 x 33 x 37 3/4	35 7/8 x 33 x 44 1/4	35 7/8 x 33 x 52 1/2
# of Shelves (Size (L x D) (in.))	-	1 (31 5/8 x 14)	2 (31 5/8 x 10, 31 5/8 x 14)
Net / Gross Weight (lbs.)	335 / 412	368 / 447	401 / 482

ELECTRICAL/DIMENSIONAL DATA	TOM-48L-UF-W(B, S)-1SI-N	TOM-48L-UF-W(B, S)-2SI-N	TOM-48L-UF-W(B, S)-3SI-N
Voltage	115/60/1	115/60/1	115/60/1
Plug Type	☺ NEMA 5-20P	☺ NEMA 5-20P	☺ NEMA 5-20P
Full Load Amp.	13.6	13.6	13.6
Compressor HP	3/4 x 2	3/4 x 2	3/4 x 2
Refrigerant	R-290	R-290	R-290
Net Capacity (cu. ft.)	6.3	10.2	15.2
Ext. Dimension (L x D x H*) (in.)	47 7/8 x 33 x 37 3/4	47 7/8 x 33 x 44 1/4	47 7/8 x 33 x 52 1/2
# of Shelves (Size (L x D) (in.))	-	1 (43 5/8 x 14)	2 (43 5/8 x 10, 43 5/8 x 14)
Net / Gross Weight (lbs.)	416 / 504	438 / 528	462 / 550

Design and specifications subject to change without notice. Most updated spec sheets are available at www.turboairinc.com.

Actual shipping weight may differ due to extra packing materials for product protection.

* Height does not include 5/8" for bolt height.

■ **WARRANTY: 2 Year Parts and Labor Warranty, 5 Year Compressor Warranty**

DROP-IN TYPE HORIZONTAL OPEN DISPLAY CASES

Self-Cleaning Condenser Equipped Units

Self-Cleaning Condenser (Patented)

The accumulation of dust in the condenser can cause the failure or breakdown of refrigerators. Refrigerators run normally until they reach a certain level of accumulation. At some point, when they are over the limit, their performance drops quickly resulting in damage to, or disposal of the stored products inside. The Self-Cleaning Condenser device keeps the condenser clean and prevents system failure by automatically brushing daily.

Hydrocarbon refrigerants (R-290)

With innovative and eco-friendly technology, Turbo Air brings you hydrocarbon refrigerators designed to meet DOE's Energy Conservation Standards in 2017 and to use EPA's SNAP Program approved HC refrigerants. Hydrocarbon refrigerants do not deplete the ozone layer and have very low contribution to global warming (ODP-0, GWP-3).

Modern design

By integrating great contours with durable structures, our modern style product designs are user-friendly while maintaining the highest product visibility and aesthetics. Safety reinforced tempered glass front shield and side walls optimize the merchandiser's display effects of fresh salads, sandwiches, desserts and beverages. Its elegant contemporary euro design will enhance any store application.

Standard back-guard improves airflow

Stainless steel interior standard including back wall and deck pans

Bottom stainless steel solid shelf and glass shelves standard

Perforated interior back wall & top for improved airflow

Foamed with polyurethane, high-density cell insulation (CFC free)

LED interior lighting

Front air intake and rear air discharge

Stainless steel color option available



Standard features

- Simple plug-in installation
- No plumbing required
- White and black colors come standard
- Solar powered digital thermometer
- Digital electronic thermostat with defrost control
- Energy saving night curtain
- Lead time applies

Recommended operating conditions

TOM models are designed to operate in an environment where temperature & humidity do not exceed 80°F and 55% respectively. Units should not be installed near HVAC vents, fans or doorways that will disrupt the air curtain and compromise the function of the cabinet. Air curtain models will run most efficiently when completely loaded with product. When used as a built-in, required clearance for the rear is 4" and the top is 5".

TOM-L-UF MODELS SPECIFICATIONS

ELECTRICAL/DIMENSIONAL DATA	TOM-60L-UF-W(B, S)-1SI-N	TOM-60L-UF-W(B, S)-2SI-N	TOM-60L-UF-W(B, S)-3SI-N
Voltage	115/60/1	115/60/1	115/60/1
Plug Type	Ⓢ NEMA 5-20P	Ⓢ NEMA 5-20P	Ⓢ NEMA 5-20P
Full Load Amp.	15.0	15.0	15.0
Compressor HP	3/4 x 2	3/4 x 2	3/4 x 2
Refrigerant	R-290	R-290	R-290
Net Capacity (cu. ft.)	8.0	13.0	19.3
Ext. Dimension (L x D x H*) (in.)	59 ⁷ / ₈ x 33 x 37 ³ / ₄	59 ⁷ / ₈ x 33 x 44 ¹ / ₄	59 ⁷ / ₈ x 33 x 52 ¹ / ₂
# of Shelves (Size (L x D) (in.))	-	1 (55 ⁵ / ₈ x 14)	2 (55 ⁵ / ₈ x 10, 55 ⁵ / ₈ x 14)
Net / Gross Weight (lbs.)	449 / 548	482 / 584	526 / 631

ELECTRICAL/DIMENSIONAL DATA	TOM-72L-UF-W(B, S)-1SI-N	TOM-72L-UF-W(B, S)-2SI-N	TOM-72L-UF-W(B, S)-3SI-N
Voltage	220/60/1	220/60/1	220/60/1
Plug Type	Ⓢ NEMA 6-20P	Ⓢ NEMA 6-20P	Ⓢ NEMA 6-20P
Full Load Amp.	13.0	13.0	13.0
Compressor HP	3/4 x 4	3/4 x 4	3/4 x 4
Refrigerant	R-290	R-290	R-290
Net Capacity (cu. ft.)	9.7	15.8	23.4
Ext. Dimension (L x D x H*) (in.)	71 ⁷ / ₈ x 33 x 37 ³ / ₄	71 ⁷ / ₈ x 33 x 44 ¹ / ₄	71 ⁷ / ₈ x 33 x 52 ¹ / ₂
# of Shelves (Size (L x D) (in.))	-	2 (33 ¹ / ₂ x 14)	2 (33 ¹ / ₂ x 10), 2 (33 ¹ / ₂ x 14)
Net / Gross Weight (lbs.)	659 / 769	690 / 805	734 / 854

Design and specifications subject to change without notice. Most updated spec sheets are available at www.turboairinc.com.

Actual shipping weight may differ due to extra packing materials for product protection.

* Height does not include 5/8" for bolt height.

WARRANTY: 2 Year Parts and Labor Warranty, 5 Year Compressor Warranty

DROP-IN TYPE HORIZONTAL OPEN DISPLAY CASES

Self-Cleaning Condenser Equipped Units

■ **Self-Cleaning Condenser (Patented)**

The accumulation of dust in the condenser can cause the failure or breakdown of refrigerators. Refrigerators run normally until they reach a certain level of accumulation. At some point, when they are over the limit, their performance drops quickly resulting in damage to, or disposal of the stored products inside. The Self-Cleaning Condenser device keeps the condenser clean and prevents system failure by automatically brushing daily.

■ **Hydrocarbon refrigerants (R-290)**

With innovative and eco-friendly technology, Turbo Air brings you hydrocarbon refrigerators designed to meet DOE's Energy Conservation Standards in 2017 and to use EPA's SNAP Program approved HC refrigerants. Hydrocarbon refrigerants do not deplete the ozone layer and have very low contribution to global warming (ODP-0, GWP-3).

■ **Modern design**

By integrating great contours with durable structures, our modern style product designs are user-friendly while maintaining the highest product visibility and aesthetics. Safety reinforced tempered glass front shield and side walls optimize the merchandiser's display effects of fresh salads, sandwiches, desserts and beverages. Its elegant contemporary euro design will enhance any store application.

■ **Standard back-guard improves airflow**

■ **Bottom stainless steel solid shelf and glass shelves standard**

■ **Perforated glass doors & open top for improved airflow**

■ **Foamed with polyurethane, high-density cell insulation (CFC free)**

■ **LED interior lighting**

■ **Front air intake and rear air discharge**

■ **Sliding rear door for product loading & unloading**

■ **Stainless steel color option available**



TOM-48L-UFD-W-3SI-N

TOM-36L-UFD-B-2SI-N

* Bottom portion will not be visible after installation

Self-Cleaning Condenser
Maintenance-free during warranty period

■ **Standard features**

- Simple plug-in installation
- No plumbing required
- White and black colors come standard
- Solar powered digital thermometer
- Digital electronic thermostat with defrost control
- Energy saving night curtain
- Lead time applies

- **Recommended operating conditions**

TOM models are designed to operate in an environment where temperature & humidity do not exceed 80°F and 55% respectively. Units should not be installed near HVAC vents, fans or doorways that will disrupt the air curtain and compromise the function of the cabinet. Air curtain models will run most efficiently when completely loaded with product. When used as a built-in, required clearance for the rear is 4" and the top is 5".

TOM-L-UFD MODELS SPECIFICATIONS

ELECTRICAL/DIMENSIONAL DATA	TOM-36L-UFD-W(B, S)-1SI-N	TOM-36L-UFD-W(B, S)-2SI-N	TOM-36L-UFD-W(B, S)-3SI-N
Voltage	115/60/1	115/60/1	115/60/1
Plug Type	⊕ NEMA 5-20P	⊕ NEMA 5-20P	⊕ NEMA 5-20P
Full Load Amp.	11.3	11.3	11.3
Compressor HP	3/4 x 2	3/4 x 2	3/4 x 2
Refrigerant	R-290	R-290	R-290
Net Capacity (cu. ft.)	4.6	7.5	11.1
Ext. Dimension (L x D x H*) (in.)	35 7/8 x 33 3/4 x 37 3/4	35 7/8 x 33 3/4 x 44 1/4	35 7/8 x 33 3/4 x 52 1/2
# of Shelves (Size (L x D) (in.))	-	1 (31 5/8 x 14)	2 (31 5/8 x 10, 31 5/8 x 14)
Net / Gross Weight (lbs.)	344 / 421	382 / 461	418 / 499

ELECTRICAL/DIMENSIONAL DATA	TOM-48L-UFD-W(B, S)-1SI-N	TOM-48L-UFD-W(B, S)-2SI-N	TOM-48L-UFD-W(B, S)-3SI-N
Voltage	115/60/1	115/60/1	115/60/1
Plug Type	⊕ NEMA 5-20P	⊕ NEMA 5-20P	⊕ NEMA 5-20P
Full Load Amp.	13.6	13.6	13.6
Compressor HP	3/4 x 2	3/4 x 2	3/4 x 2
Refrigerant	R-290	R-290	R-290
Net Capacity (cu. ft.)	6.3	10.2	15.2
Ext. Dimension (L x D x H*) (in.)	47 7/8 x 33 3/4 x 37 3/4	47 7/8 x 33 3/4 x 44 1/4	47 7/8 x 33 3/4 x 52 1/2
# of Shelves (Size (L x D) (in.))	-	1 (43 5/8 x 14)	2 (43 5/8 x 10, 43 5/8 x 14)
Net / Gross Weight (lbs.)	432 / 520	457 / 547	486 / 574

Design and specifications subject to change without notice. Most updated spec sheets are available at www.turboairinc.com.

Actual shipping weight may differ due to extra packing materials for product protection.

* Height does not include 5/8" for bolt height.

■ **WARRANTY: 2 Year Parts and Labor Warranty, 5 Year Compressor Warranty**

DROP-IN TYPE HORIZONTAL OPEN DISPLAY CASES

Self-Cleaning Condenser Equipped Units

Self-Cleaning Condenser (Patented)

The accumulation of dust in the condenser can cause the failure or breakdown of refrigerators. Refrigerators run normally until they reach a certain level of accumulation. At some point, when they are over the limit, their performance drops quickly resulting in damage to, or disposal of the stored products inside. The Self-Cleaning Condenser device keeps the condenser clean and prevents system failure by automatically brushing daily.

Hydrocarbon refrigerants (R-290)

With innovative and eco-friendly technology, Turbo Air brings you hydrocarbon refrigerators designed to meet DOE's Energy Conservation Standards in 2017 and to use EPA's SNAP Program approved HC refrigerants. Hydrocarbon refrigerants do not deplete the ozone layer and have very low contribution to global warming (ODP-0, GWP-3).

Modern design

By integrating great contours with durable structures, our modern style product designs are user-friendly while maintaining the highest product visibility and aesthetics. Safety reinforced tempered glass front shield and side walls optimize the merchandiser's display effects of fresh salads, sandwiches, desserts and beverages. Its elegant contemporary euro design will enhance any store application.

Standard back-guard improves airflow

Bottom stainless steel solid shelf and glass shelves standard

Perforated glass doors & open top for improved airflow

Foamed with polyurethane, high-density cell insulation (CFC free)

LED interior lighting

Front air intake and rear air discharge

Sliding rear door for product loading & unloading

Stainless steel color option available



TOM-60L-UFD-W-3SI-N

* Bottom portion will not be visible after installation

TOM-60L-UFD-B-2SI-N

Self-Cleaning Condenser
Maintenance-free
during warranty period

Standard features

- Simple plug-in installation
- No plumbing required
- White and black colors come standard
- Solar powered digital thermometer
- Digital electronic thermostat with defrost control
- Energy saving night curtain
- Lead time applies

Recommended operating conditions

TOM models are designed to operate in an environment where temperature & humidity do not exceed 80°F and 55% respectively. Units should not be installed near HVAC vents, fans or doorways that will disrupt the air curtain and compromise the function of the cabinet. Air curtain models will run most efficiently when completely loaded with product. When used as a built-in, required clearance for the rear is 4" and the top is 5".

TOM-L-UFD MODELS SPECIFICATIONS

ELECTRICAL/DIMENSIONAL DATA	TOM-60L-UFD-W(B, S)-1SI-N	TOM-60L-UFD-W(B, S)-2SI-N	TOM-60L-UFD-W(B, S)-3SI-N
Voltage	115/60/1	115/60/1	115/60/1
Plug Type	Ⓢ NEMA 5-20P	Ⓢ NEMA 5-20P	Ⓢ NEMA 5-20P
Full Load Amp.	15.0	15.0	15.0
Compressor HP	3/4 x 2	3/4 x 2	3/4 x 2
Refrigerant	R-290	R-290	R-290
Net Capacity (cu. ft.)	8.0	13.0	19.3
Ext. Dimension (L x D x H*) (in.)	59 7/8 x 33 3/4 x 37 3/4	59 7/8 x 33 3/4 x 44 1/4	59 7/8 x 33 3/4 x 52 1/2
# of Shelves (Size (L x D) (in.))	-	1 (55 5/8 x 14)	2 (55 5/8 x 10, 55 5/8 x 14)
Net / Gross Weight (lbs.)	467 / 566	504 / 606	556 / 661

ELECTRICAL/DIMENSIONAL DATA	TOM-72L-UFD-W(B, S)-1SI-N	TOM-72L-UFD-W(B, S)-2SI-N	TOM-72L-UFD-W(B, S)-3SI-N
Voltage	220/60/1	220/60/1	220/60/1
Plug Type	Ⓢ NEMA 6-20P	Ⓢ NEMA 6-20P	Ⓢ NEMA 6-20P
Full Load Amp.	13.0	13.0	13.0
Compressor HP	3/4 x 4	3/4 x 4	3/4 x 4
Refrigerant	R-290	R-290	R-290
Net Capacity (cu. ft.)	9.7	15.8	23.4
Ext. Dimension (L x D x H*) (in.)	71 7/8 x 33 3/4 x 37 3/4	71 7/8 x 33 3/4 x 44 1/4	71 7/8 x 33 3/4 x 52 1/2
# of Shelves (Size (L x D) (in.))	-	2 (33 1/2 x 14)	2 (33 1/2 x 10), 2 (33 1/2 x 14)
Net / Gross Weight (lbs.)	683 / 793	720 / 835	773 / 893

Design and specifications subject to change without notice. Most updated spec sheets are available at www.turboairinc.com.

Actual shipping weight may differ due to extra packing materials for product protection.

* Height does not include 5/8" for bolt height.

WARRANTY: 2 Year Parts and Labor Warranty, 5 Year Compressor Warranty

DROP-IN TYPE HORIZONTAL OPEN DISPLAY CASES

Self-Cleaning Condenser Equipped Units

■ **Self-Cleaning Condenser (Patented)**

The accumulation of dust in the condenser can cause the failure or breakdown of refrigerators. Refrigerators run normally until they reach a certain level of accumulation. At some point, when they are over the limit, their performance drops quickly resulting in damage to, or disposal of the stored products inside. The Self-Cleaning Condenser device keeps the condenser clean and prevents system failure by automatically brushing daily.

■ **Hydrocarbon refrigerants (R-290)**

With innovative and eco-friendly technology, Turbo Air brings you hydrocarbon refrigerators designed to meet DOE's Energy Conservation Standards in 2017 and to use EPA's SNAP Program approved HC refrigerants. Hydrocarbon refrigerants do not deplete the ozone layer and have very low contribution to global warming (ODP-0, GWP-3).

■ **Modern design**

By integrating great contours with durable structures, our modern style product designs are user-friendly while maintaining the highest product visibility and aesthetics. Safety reinforced tempered glass front shield optimize the merchandiser's display effects of fresh salads, sandwiches, desserts and beverages. Its elegant contemporary euro design will enhance any store application.

■ **Standard back-guard improves airflow**

■ **Stainless steel interior standard including back wall and deck pans**

■ **Perforated interior back wall & top for improved airflow**

■ **Foamed with polyurethane, high-density cell insulation (CFC free)**

■ **LED interior lighting**

■ **Stainless steel color option available**

■ **Standard features**

- Simple plug-in installation
- No plumbing required
- White and black colors come standard
- Solar powered digital thermometer
- Digital electronic thermostat with defrost control
- Energy saving night curtain
- Lead time applies

- **Recommended operating conditions**

TOM models are designed to operate in an environment where temperature & humidity do not exceed 80°F and 55% respectively. Units should not be installed near HVAC vents, fans or doorways that will disrupt the air curtain and compromise the function of the cabinet. Air curtain models will run most efficiently when completely loaded with product. When used as a built-in, required clearance for the rear is 4" and 4-1/2" from the floor to the underside of the front panel.



TOM-36UC-B-N



TOM-48UC-B-N

※ Bottom portion will not be visible after installation



TOM-72UC-W-N

Self-Cleaning Condenser
Maintenance-free during warranty period

TOM-UC MODELS SPECIFICATIONS

ELECTRICAL DATA	TOM-36UC-W(B, S)-N	TOM-48UC-W(B, S)-N	TOM-60UC-W(B, S)-N	TOM-72UC-W(B, S)-N
Voltage	115/60/1	115/60/1	115/60/1	115/60/1
Plug Type	Ⓢ NEMA 5-15P	Ⓢ NEMA 5-15P	Ⓢ NEMA 5-15P	Ⓢ NEMA 5-20P
Full Load Amp.	7.5	7.5	7.5	15.0
Compressor HP	3/4	3/4	3/4	3/4 x 2
Refrigerant	R-290	R-290	R-290	R-290
DIMENSIONAL DATA				
Net Capacity (cu. ft.)	5.0	6.8	8.6	10.4
Ext. Dimensions (L x D x H*) (in.)	36 1/4 x 32 1/4 x 32 1/2	48 1/4 x 32 1/4 x 32 1/2	60 1/4 x 32 1/4 x 32 1/2	72 1/4 x 32 1/4 x 32 1/2
Net Weight (lbs.)	302	346	394	520
Gross Weight (lbs.)	368	423	482	630

Design and specifications subject to change without notice. Most updated spec sheets are available at www.turboairinc.com.

Actual shipping weight may differ due to extra packing materials for product protection.

* Height does not include 1/4" for roller height.

■ **WARRANTY: 2 Year Parts and Labor Warranty, 5 Year Compressor Warranty**

SANDWICH & CHEESE DISPLAY CASES



Self-Cleaning Condenser Equipped Units

■ **Self-Cleaning Condenser (Patented)**

The accumulation of dust in the condenser can cause the failure or breakdown of refrigerators. Refrigerators run normally until they reach a certain level of accumulation. At some point, when they are over the limit, their performance drops quickly resulting in damage to, or disposal of the stored products inside. The Self-Cleaning Condenser device keeps the condenser clean and prevents system failure by automatically brushing daily.

■ **Hydrocarbon refrigerants (R-290)**

With innovative and eco-friendly technology, Turbo Air brings you hydrocarbon refrigerators designed to meet DOE's Energy Conservation Standards in 2017 and to use EPA's SNAP Program approved HC refrigerants. Hydrocarbon refrigerants do not deplete the ozone layer and have very low contribution to global warming (ODP-0, GWP-3).

■ **High-density polyurethane insulation**

The entire cabinet structure is foamed-in-place using high density, CFC free polyurethane insulation.

■ **Digital temperature controller**

■ **Single pane glass is tempered for safety**

■ **Stainless steel airflow grille**

■ **Bottom lit, LED interior lighting**

■ **Stainless steel color option available**

■ **Standard features**

- No plumbing required
- White and black colors come standard
- 3" dia. swivel casters with locks on the rear set
- Lead time applies

- **Recommended operating conditions**

TOS models are designed to operate in an environment where temperature & humidity do not exceed 75°F and 55% respectively.



TOS-30NN-D-W

TOS-40NN-B



Self-Cleaning Condenser
Maintenance-free during warranty period

TOS-50PN-B

TOS MODELS SPECIFICATIONS

ELECTRICAL/DIMENSIONAL DATA	TOS-30NN-W(B, S)	TOS-40NN-W(B, S)	TOS-50NN-W(B, S)	TOS-30NN-D-W(B, S)	TOS-40NN-D-W(B, S)
Voltage	115/60/1	115/60/1	115/60/1	115/60/1	115/60/1
Plug Type	① NEMA 5-15P	① NEMA 5-15P	① NEMA 5-15P	① NEMA 5-15P	① NEMA 5-15P
Full Load Amp.	5.9	6	6	5.9	6
Compressor HP	1/3	1/3	1/3	1/3	1/3
Refrigerant	R-290	R-290	R-290	R-290	R-290
Load Line Net Capacity (cu. ft.)	1.51	2.08	2.71	1.51	2.08
Ext. Dimension (L x D x H*) (in.)	30 x 35 ³ / ₈ x 31	40 ¹ / ₄ x 35 ³ / ₈ x 31	50 ¹ / ₄ x 35 ³ / ₈ x 31	30 x 35 ³ / ₈ x 40 ¹ / ₂	40 ¹ / ₄ x 35 ³ / ₈ x 40 ¹ / ₂
Net / Gross Weight (lbs.)	309 / 464	375 / 552	441 / 640	316 / 481	385 / 572

ELECTRICAL/DIMENSIONAL DATA	TOS-50NN-D-W(B, S)	TOS-30PN-W(B, S)	TOS-40PN-W(B, S)	TOS-50PN-W(B, S)
Voltage	115/60/1	115/60/1	115/60/1	115/60/1
Plug Type	① NEMA 5-15P	① NEMA 5-15P	① NEMA 5-15P	① NEMA 5-15P
Full Load Amp.	6	5.7	5.9	6
Compressor HP	1/3	1/3	1/3	1/3
Refrigerant	R-290	R-290	R-290	R-290
Load Line Net Capacity (cu. ft.)	2.71	1.62	2.26	2.91
Ext. Dimension (L x D x H*) (in.)	50 ¹ / ₄ x 35 ³ / ₈ x 40 ¹ / ₂	30 x 35 ³ / ₈ x 34 ¹ / ₈	40 ¹ / ₄ x 35 ³ / ₈ x 34 ¹ / ₈	50 ¹ / ₄ x 35 ³ / ₈ x 34 ¹ / ₈
Net / Gross Weight (lbs.)	454 / 664	290 / 456	355 / 543	425 / 625

Design and specifications subject to change without notice. Most updated spec sheets are available at www.turboairinc.com.

Actual shipping weight may differ due to extra packing materials for product protection.

* Height does not include 2-1/4" for caster height.

■ **WARRANTY: 2 Year Parts and Labor Warranty, 5 Year Compressor Warranty**

VERTICAL OPEN DISPLAY CASES NATURAL Refrigerant

Self-Cleaning Condenser Equipped Units

■ **Self-Cleaning Condenser (Patented)**

The accumulation of dust in the condenser can cause the failure or breakdown of refrigerators. Refrigerators run normally until they reach a certain level of accumulation. At some point, when they are over the limit, their performance drops quickly resulting in damage to, or disposal of the stored products inside. The Self-Cleaning Condenser device keeps the condenser clean and prevents system failure by automatically brushing daily.

■ **Hydrocarbon refrigerants (R-290)**

With innovative and eco-friendly technology, Turbo Air brings you hydrocarbon refrigerators designed to meet DOE's Energy Conservation Standards in 2017 and to use EPA's SNAP Program approved HC refrigerants. Hydrocarbon refrigerants do not deplete the ozone layer and have very low contribution to global warming (ODP-0, GWP-3).

■ **Modern design**

By integrating great contours with durable structures, our modern style product designs are user-friendly while maintaining the highest product visibility and aesthetics. Safety reinforced tempered glass front shield and side walls optimize the merchandiser's display effects of fresh salads, sandwiches, desserts and beverages. Its elegant contemporary euro design will enhance any store application.

■ **Designed to enhance impulsive sales**

Ideal for eye-catching displays and convenient access with fast service in high traffic area.

■ **Tempered glass shelves standard (Cantilever type)**

■ **Standard back-guard improves airflow**

■ **Foamed with polyurethane, high-density cell insulation (CFC free)**

■ **Perforated interior back wall and top for improved airflow**

■ **Front air intake and rear air discharge**

■ **Digital temperature controller**

■ **Stainless steel color option available**

■ **Standard features**

- Simple plug-in installation
- No plumbing required
- White and black colors come standard
- Digital electronic thermostat with defrost control
- LED interior lighting
- 2.5" dia. swivel casters with lock on the front set
- Lead time applies



Self-Cleaning Condenser
Maintenance-free during warranty period

TOM20-60N-W

TOM20-75N-B

■ **Optional features**

- Price tag channel available

- **Recommended operating conditions**

TOM models are designed to operate in an environment where temperature & humidity do not exceed 80°F and 55% respectively. Units should not be installed near HVAC vents, fans or doorways that will disrupt the air curtain and compromise the function of the cabinet. Air curtain models will run most efficiently when completely loaded with product. When used as a built-in, required clearance for the rear is 4" and the top is 5".

TOM MODELS SPECIFICATIONS

ELECTRICAL DATA	TOM20-60N-W(B, S)	TOM20-75N-W(B, S)
Voltage	115/60/1	115/60/1
Plug Type	Ⓢ NEMA 5-20P	Ⓢ NEMA 5-20P
Full Load Amp.	8.1	8
Compressor HP	3/4	3/4
Refrigerant	R-290	R-290
DIMENSIONAL DATA		
Net Capacity (cu. ft.)	3.2	4.8
Ext. Dimension (L x D [†] x H [†]) (in.)	19 ³ / ₄ x 25 ⁵ / ₈ x 56 ³ / ₄	19 ³ / ₄ x 25 ⁵ / ₈ x 72 ¹ / ₂
# of Shelves	2	4
Shelf Size (L x D) (in.)	18 ¹ / ₄ x 9, 18 ¹ / ₄ x 11	18 ¹ / ₄ x 9, 18 ¹ / ₄ x 11
Net Weight (lbs.)	285	366
Gross Weight (lbs.)	330	440

Design and specifications subject to change without notice. Most updated spec sheets are available at www.turboairinc.com.

Actual shipping weight may differ due to extra packing materials for product protection.

* Depth does not include 2" for rear spacers. † Height does not include 2-3/4" for caster height.

■ **WARRANTY: 2 Year Parts and Labor Warranty, 5 Year Compressor Warranty**

VERTICAL OPEN DISPLAY CASES NATURAL Refrigerant

Self-Cleaning Condenser Equipped Units

Self-Cleaning Condenser (Patented)

The accumulation of dust in the condenser can cause the failure or breakdown of refrigerators. Refrigerators run normally until they reach a certain level of accumulation. At some point, when they are over the limit, their performance drops quickly resulting in damage to, or disposal of the stored products inside. The Self-Cleaning Condenser device keeps the condenser clean and prevents system failure by automatically brushing daily.

Hydrocarbon refrigerants (R-290)

With innovative and eco-friendly technology, Turbo Air brings you hydrocarbon refrigerators designed to meet DOE's Energy Conservation Standards in 2017 and to use EPA's SNAP Program approved HC refrigerants. Hydrocarbon refrigerants do not deplete the ozone layer and have very low contribution to global warming (ODP-0, GWP-3).

Modern design

By integrating great contours with durable structures, our modern style product designs are user-friendly while maintaining the highest product visibility and aesthetics. Safety reinforced tempered glass front shield and side walls optimize the merchandiser's display effects of fresh salads, sandwiches, desserts and beverages. Its elegant contemporary euro design will enhance any store application.

Designed to enhance impulsive sales

Ideal for eye-catching displays and convenient access with fast service in high traffic area.

Stainless steel solid shelves standard

Standard back-guard improves airflow

Energy saving night curtain standard

Optional security cover available

Foamed with polyurethane, high-density cell insulation (CFC free)

Perforated interior back wall and top for improved airflow

Front air intake and rear air discharge

Stainless steel color option available

LED interior lighting under each shelf



Self-Cleaning Condenser
Maintenance-free during warranty period
TOM-50MS-N



TOM-40B-N

Standard features

- Simple plug-in installation
- Patented self-contained system, no plumbing required
- White and black colors come standard
- Solar powered digital thermometer
- Digital electronic thermostat with defrost control

Optional features

- Security cover available
- Price tag channel available
- Leveling leg available
- Casters available

Recommended operating conditions

TOM models are designed to operate in an environment where temperature & humidity do not exceed 75°F and 55% respectively. Units should not be installed near HVAC vents, fans or doorways that will disrupt the air curtain and compromise the function of the cabinet. Air curtain models will run most efficiently when completely loaded with product. When used as a built-in, required clearance for the rear is 4" and the top is 5".

TOM-M/TOM MODELS SPECIFICATIONS

ELECTRICAL DATA	TOM-40MW(B, S)-N	TOM-50MW(B, S)-N	TOM-40W(B, S)-N	TOM-50W(B, S)-N
Voltage	115/60/1	115/60/1	115/60/1	115/60/1
Plug Type	Ⓢ NEMA 5-20P	Ⓢ NEMA 5-20P	Ⓢ NEMA 5-20P	Ⓢ NEMA 5-20P
Full Load Amp.	15.5	15.5	15.5	15.5
Compressor HP	3/4 x 2	3/4 x 2	3/4 x 2	3/4 x 2
Refrigerant	R-290	R-290	R-290	R-290
DIMENSIONAL DATA				
Net Capacity (cu. ft.)	9.3	12.3	14.4	19.0
Ext. Dimension (L x D x H) [†] (in.)	39 1/8 x 26 7/8 x 60 1/4	50 7/8 x 26 7/8 x 60 1/4	39 1/8 x 27 x 78	50 7/8 x 27 x 78
# of Shelves	3	3	4	4
Shelf Size (L x D) (in.)	Top 36 1/2 x 10 3/4 Middle/Low 36 1/2 x 12	48 3/8 x 10 3/4 48 3/8 x 12	36 1/2 x 12	48 3/8 x 12
Net Weight (lbs.)	421	463	512	590
Gross Weight (lbs.)	521	567	642	733

Design and specifications subject to change without notice. Most updated spec sheets are available at www.turboairinc.com.

Actual shipping weight may differ due to extra packing materials for product protection.

* Depth does not include 1-1/4" for rear spacers. † Height does not include 5/8" for bolt height.

WARRANTY: 2 Year Parts and Labor Warranty, 5 Year Compressor Warranty

VERTICAL OPEN DISPLAY CASES NATURAL Refrigerant

Self-Cleaning Condenser Equipped Units

■ **Self-Cleaning Condenser (Patented)**

The accumulation of dust in the condenser can cause the failure or breakdown of refrigerators. Refrigerators run normally until they reach a certain level of accumulation. At some point, when they are over the limit, their performance drops quickly resulting in damage to, or disposal of the stored products inside. The Self-Cleaning Condenser device keeps the condenser clean and prevents system failure by automatically brushing daily.

■ **Hydrocarbon refrigerants (R-290)**

With innovative and eco-friendly technology, Turbo Air brings you hydrocarbon refrigerators designed to meet DOE's Energy Conservation Standards in 2017 and to use EPA's SNAP Program approved HC refrigerants. Hydrocarbon refrigerants do not deplete the ozone layer and have very low contribution to global warming (ODP-0, GWP-3).

■ **Modern design**

By integrating great contours with durable structures, our modern style product designs are user-friendly while maintaining the highest product visibility and aesthetics. Safety reinforced tempered glass front shield optimizes the merchandiser's display effects of fresh salads, sandwiches, desserts and beverages. Its elegant contemporary euro design will enhance any store application.

■ **Designed to enhance impulsive sales**

Ideal for eye-catching displays and convenient access with fast service in high traffic area.

■ **Interior materials available in two standards**

SP: stainless steel interior for sanitary purposes.
SP-A: black coated interior with mirrored sides for maximized display effects.

■ **Solid side panels used to ensure durability**

■ **Standard back-guard improves airflow**

■ **Energy saving night curtain standard**

■ **Optional security cover available (TOM-40/50B-SP-A-N)**

■ **Foamed with polyurethane, high-density cell insulation (CFC free)**

■ **Perforated interior back wall and top for improved airflow**

■ **Front air intake and rear air discharge**

■ **LED interior lighting under each shelf**



TOM-50B-SP-A-N

* Please allow extra lead time for solid side panel option.

Self-Cleaning Condenser Maintenance-free during warranty period

TOM-50MB-SP-A-N

■ **Standard features**

- Simple plug-in installation
- Patented self-contained system, no plumbing required
- Standard color comes in black only
- Solar powered digital thermometer
- Digital electronic thermostat with defrost control

■ **Optional features**

- Security cover available
- Price tag channel available
- Leveling leg available
- Casters available

- **Recommended operating conditions**

TOM models are designed to operate in an environment where temperature & humidity do not exceed 75°F and 55% respectively. Units should not be installed near HVAC vents, fans or doorways that will disrupt the air curtain and compromise the function of the cabinet. Air curtain models will run most efficiently when completely loaded with product. When used as a built-in, required clearance for the rear is 4" and the top is 5".

TOM-M/TOM MODELS SPECIFICATIONS

ELECTRICAL DATA		TOM-40MB-SP(-A)-N	TOM-50MB-SP(-A)-N	TOM-40B-SP(-A)-N	TOM-50B-SP(-A)-N
Voltage		115/60/1	115/60/1	115/60/1	115/60/1
Plug Type		Ⓢ NEMA 5-20P	Ⓢ NEMA 5-20P	Ⓢ NEMA 5-20P	Ⓢ NEMA 5-20P
Full Load Amp.		15.5	15.5	15.5	15.5
Compressor HP		3/4 x 2	3/4 x 2	3/4 x 2	3/4 x 2
Refrigerant		R-290	R-290	R-290	R-290
DIMENSIONAL DATA					
Net Capacity (cu. ft.)		9.3	12.3	14.4	19.0
Ext. Dimension (L x D* x H†) (in.)		39 1/8 x 26 7/8 x 60 1/4	50 7/8 x 26 7/8 x 60 1/4	39 1/8 x 27 x 78	50 7/8 x 27 x 78
# of Shelves		3	3	4	4
Shelf Size (L x D) (in.)	Top	36 1/2 x 10 3/4	48 3/8 x 10 3/4	36 1/2 x 12	48 3/8 x 12
	Middle/Low	36 1/2 x 12	48 3/8 x 12		
Net Weight (lbs.)		421	463	512	590
Gross Weight (lbs.)		521	567	642	733

Design and specifications subject to change without notice. Most updated spec sheets are available at www.turboairinc.com.

Actual shipping weight may differ due to extra packing materials for product protection.

* Depth does not include 1-1/4" for rear spacers. † Height does not include 5/8" for bolt height.

■ **WARRANTY: 2 Year Parts and Labor Warranty, 5 Year Compressor Warranty**

VERTICAL OPEN DISPLAY CASES NATURAL Refrigerant

Self-Cleaning Condenser Equipped Units

■ **Self-Cleaning Condenser (Patented)**

The accumulation of dust in the condenser can cause the failure or breakdown of refrigerators. Refrigerators run normally until they reach a certain level of accumulation. At some point, when they are over the limit, their performance drops quickly resulting in damage to, or disposal of the stored products inside. The Self-Cleaning Condenser device keeps the condenser clean and prevents system failure by automatically brushing daily.

■ **Hydrocarbon refrigerants (R-290)**

With innovative and eco-friendly technology, Turbo Air brings you hydrocarbon refrigerators designed to meet DOE's Energy Conservation Standards in 2017 and to use EPA's SNAP Program approved HC refrigerants. Hydrocarbon refrigerants do not deplete the ozone layer and have very low contribution to global warming (ODP-0, GWP-3).

■ **Modern design**

By integrating great contours with durable structures, our modern style product designs are user-friendly while maintaining the highest product visibility and aesthetics. Safety reinforced tempered glass front shield and side walls optimize the merchandiser's display effects of fresh salads, sandwiches, desserts and beverages. Its elegant contemporary euro design will enhance any store application.

■ **Designed to enhance impulsive sales**

Ideal for eye-catching displays and convenient access with fast service in high traffic area.

■ **Standard back-guard improves airflow**

■ **Energy saving night curtain standard**

■ **Optional security cover available**

■ **Foamed with polyurethane, high-density cell insulation (CFC free)**

■ **Perforated interior back wall and top for improved airflow**

■ **Front air intake and rear air discharge**

■ **LED interior lighting under each shelf**

■ **Stainless steel color option available**



Security cover (optional)



TOM-48DXS-N



Self-Cleaning Condenser Maintenance-free during warranty period

TOM-60DXB-N

■ **Standard features**

- Simple plug-in installation
- Patented self-contained system, no plumbing required
- Standard color comes in black only
- Solar powered digital thermometer
- Digital electronic thermostat with defrost control
- Advertising panel

■ **Optional features**

- Security cover available
- Price tag channel available
- Leveling leg available
- Casters available

- **Recommended operating conditions**

TOM models are designed to operate in an environment where temperature & humidity do not exceed 75°F and 55% respectively. Units should not be installed near HVAC vents, fans or doorways that will disrupt the air curtain and compromise the function of the cabinet. Air curtain models will run most efficiently when completely loaded with product. When used as a built-in, required clearance for the rear is 4" and the top is 5".

TOM-DX MODELS SPECIFICATIONS

ELECTRICAL DATA	TOM-36DXB(S)-N	TOM-48DXB(S)-N	TOM-60DXB(S)-N	TOM-72DXB(S)-N
Voltage	115/60/1	115/60/1	115/60/1	220/60/1
Plug Type	Ⓢ NEMA 5-20P	Ⓢ NEMA 5-20P	Ⓢ NEMA 5-20P	Ⓢ NEMA 6-20P
Full Load Amp.	15.5	15.5	15.5	18
Compressor HP	3/4 x 2	3/4 x 2	3/4 x 2	3/4 x 4
Refrigerant	R-290	R-290	R-290	R-290
DIMENSIONAL DATA				
Net Capacity (cu. ft.)	17.1	23.2	29.4	34.1
Ext. Dimension (L x D x H†) (in.)	35 ⁵ / ₈ x 33 ¹ / ₄ x 78 ³ / ₈	47 ⁵ / ₈ x 33 ¹ / ₄ x 78 ³ / ₈	59 ⁵ / ₈ x 33 ¹ / ₄ x 78 ³ / ₈	68 ³ / ₄ x 33 ¹ / ₄ x 78 ³ / ₈
# of Shelves	4	4	4	8
Shelf Size (L x D) (in.)	33 ¹ / ₈ x 16	45 ¹ / ₈ x 16	57 ¹ / ₈ x 16	33 ¹ / ₈ x 16
Net Weight (lbs.)	488	562	635	890
Gross Weight (lbs.)	631	727	822	1,064

Design and specifications subject to change without notice. Most updated spec sheets are available at www.turboairinc.com.

Actual shipping weight may differ due to extra packing materials for product protection.

* Depth does not include 1-1/4" for safety bar and 1-1/8" for rear spacers. † Height does not include 5/8" for bolt height.

■ **WARRANTY: 2 Year Parts and Labor Warranty, 5 Year Compressor Warranty**

VERTICAL OPEN DISPLAY CASES NATURAL Refrigerant

Self-Cleaning Condenser Equipped Units

■ **Self-Cleaning Condenser (Patented)**

The accumulation of dust in the condenser can cause the failure or breakdown of refrigerators. Refrigerators run normally until they reach a certain level of accumulation. At some point, when they are over the limit, their performance drops quickly resulting in damage to, or disposal of the stored products inside. The Self-Cleaning Condenser device keeps the condenser clean and prevents system failure by automatically brushing daily.

■ **Hydrocarbon refrigerants (R-290)**

With innovative and eco-friendly technology, Turbo Air brings you hydrocarbon refrigerators designed to meet DOE's Energy Conservation Standards in 2017 and to use EPA's SNAP Program approved HC refrigerants. Hydrocarbon refrigerants do not deplete the ozone layer and have very low contribution to global warming (ODP-0, GWP-3).

■ **Modern design**

By integrating great contours with durable structures, our modern style product designs are user-friendly while maintaining the highest product visibility and aesthetics. Safety reinforced tempered glass front shield optimizes the merchandiser's display effects of fresh salads, sandwiches, desserts and beverages. Its elegant contemporary euro design will enhance any store application. Ideal for eye-catching displays and convenient access with fast service in high traffic areas.

■ **Solid side panels used to ensure durability**

■ **Interior materials available in two standards**

SP: stainless steel interior for sanitary purposes.
 SP-A: black coated interior with mirrored sides for maximized display effects.

■ **Standard back-guard improves airflow**

■ **Energy saving night curtain standard**

■ **Optional security cover available**

■ **Foamed with polyurethane, high-density cell insulation (CFC free)**

■ **Front air intake and rear air discharge**

■ **Perforated interior back wall and top for improved airflow**

■ **Standard features**

- Simple plug-in installation
- Patented self-contained system, no plumbing required
- Standard color comes in black only
- LED interior lighting under each shelf
- Advertising panel



TOM-60DXB-SP-N

* Please allow extra lead time for solid side panel option.



Self-Cleaning Condenser
 Maintenance-free during warranty period

TOM-40DXB-SP-A-N



Security cover (optional)

■ **Optional features**

- Security cover available
- Price tag channel available
- Leveling leg available
- Casters available

- **Recommended operating conditions**

TOM models are designed to operate in an environment where temperature & humidity do not exceed 75°F and 55% respectively. Units should not be installed near HVAC vents, fans or doorways that will disrupt the air curtain and compromise the function of the cabinet. Air curtain models will run most efficiently when completely loaded with product. When used as a built-in, required clearance for the rear is 4" and the top is 5".

TOM-DX MODELS SPECIFICATIONS

ELECTRICAL DATA	TOM-36DXB-SP(-A)-N	TOM-48DXB-SP(-A)-N	TOM-60DXB-SP(-A)-N	TOM-72DXB-SP(-A)-N
Voltage	115/60/1	115/60/1	115/60/1	220/60/1
Plug Type	Ⓢ NEMA 5-20P	Ⓢ NEMA 5-20P	Ⓢ NEMA 5-20P	Ⓢ NEMA 6-20P
Full Load Amp.	15.5	15.5	15.5	18
Compressor HP	3/4 x 2	3/4 x 2	3/4 x 2	3/4 x 4
Refrigerant	R-290	R-290	R-290	R-290
DIMENSIONAL DATA				
Net Capacity (cu. ft.)	17.1	23.2	29.4	34.1
Ext. Dimension (L x D [‡] x H [†]) (in.)	35 ⁵ / ₈ x 33 ¹ / ₄ x 78 ³ / ₈	47 ⁵ / ₈ x 33 ¹ / ₄ x 78 ³ / ₈	59 ⁵ / ₈ x 33 ¹ / ₄ x 78 ³ / ₈	68 ³ / ₄ x 33 ¹ / ₄ x 78 ³ / ₈
# of Shelves	4	4	4	8
Shelf Size (L x D) (in.)	33 ¹ / ₈ x 16	45 ¹ / ₈ x 16	57 ¹ / ₈ x 16	33 ¹ / ₈ x 16
Net Weight (lbs.)	488	562	635	890
Gross Weight (lbs.)	631	727	822	1,064

Design and specifications subject to change without notice. Most updated spec sheets are available at www.turboairinc.com.

Actual shipping weight may differ due to extra packing materials for product protection.

* Depth does not include 1-1/4" for safety bar and 1-1/8" for rear spacers. † Height does not include 5/8" for bolt height.

■ **WARRANTY: 2 Year Parts and Labor Warranty, 5 Year Compressor Warranty**

VERTICAL AIR CURTAINS NATURAL Refrigerant

Self-Cleaning Condenser Equipped Units

■ **Self-Cleaning Condenser (Patented)**

The accumulation of dust in the condenser can cause the failure or breakdown of refrigerators. Refrigerators run normally until they reach a certain level of accumulation. At some point, when they are over the limit, their performance drops quickly resulting in damage to, or disposal of the stored products inside. The Self-Cleaning Condenser device keeps the condenser clean and prevents system failure by automatically brushing daily.

■ **Hydrocarbon refrigerants (R-290)**

With innovative and eco-friendly technology, Turbo Air brings you hydrocarbon refrigerators designed to meet DOE's Energy Conservation Standards in 2017 and to use EPA's SNAP Program approved HC refrigerants. Hydrocarbon refrigerants do not deplete the ozone layer and have very low contribution to global warming (ODP-0, GWP-3).

■ **Modern design**

By harmonizing curvature and rigidity, our modern style product designs are user-friendly while maintaining the highest product visibility and aesthetics. The glass front shield optimizes the merchandiser's display effects of fresh salads, sandwiches, desserts and beverages.

■ **Designed to enhance impulsive sales**

Ideal for eye-catching displays and convenient access with fast service in high traffic area.

■ **White coated galvanized steel interior**

■ **White coated galvanized steel solid shelves**

■ **Energy saving night curtain standard**

■ **Standard back-guard improves airflow**

■ **Foamed with polyurethane, high-density cell insulation (CFC free)**

■ **Perforated interior back wall and top for improved airflow**

■ **Front air intake and rear air discharge**

■ **LED interior lighting under each shelf**

■ **Stainless steel color option available**



Self-Cleaning Condenser
Maintenance-free
during warranty period

TOM-72EB-N

TOM-36ES-N

■ **Standard features**

- Simple plug-in installation
- Patented self-contained system, no plumbing required
- Standard color comes in black only
- Solar powered digital thermometer
- Digital electronic thermostat with defrost control
- Price tag channel
- Advertising panel

■ **Optional features**

- Security cover available
- Leveling leg available
- Casters available

- **Recommended operating conditions**

TOM models are designed to operate in an environment where temperature & humidity do not exceed 75°F and 55% respectively. Units should not be installed near HVAC vents, fans or doorways that will disrupt the air curtain and compromise the function of the cabinet. Air curtain models will run most efficiently when completely loaded with product. When used as a built-in, required clearance for the rear is 4" and the top is 5".

TOM-E MODELS SPECIFICATIONS

ELECTRICAL DATA	TOM-36EB(S)-N	TOM-48EB(S)-N	TOM-60EB(S)-N	TOM-72EB(S)-N	TOM-96EB(S)-N
Voltage	115/60/1	115/60/1	115/60/1	220/60/1	220/60/1
Plug Type	Ⓢ NEMA 5-20P	Ⓢ NEMA 5-20P	Ⓢ NEMA 5-20P	Ⓢ NEMA 6-20P	Ⓢ NEMA 6-20P
Full Load Amp.	15.5	15.5	15.5	18	18
Compressor HP	3/4 x 2	3/4 x 2	3/4 x 2	3/4 x 4	3/4 x 4
Refrigerant	R-290	R-290	R-290	R-290	R-290
DIMENSIONAL DATA					
Net Capacity (cu. ft.)	16.5	22.6	28.6	34.7	45.2
Ext. Dimension (L x D [*] x H [†]) (in.)	36 x 29 1/2 x 80 1/2	48 x 29 1/2 x 80 1/2	60 x 29 1/2 x 80 1/2	72 x 29 1/2 x 80 1/2	92 7/8 x 29 1/2 x 80 1/2
# of Shelves	4	4	4	8	8
Shelf Size (L x D) (in.)	32 3/4 x 15 1/2	44 3/4 x 15 1/2	56 3/4 x 15 1/2	34 1/4 x 15 1/2	44 3/4 x 15 1/2
Net Weight (lbs.)	498	573	648	723	970
Gross Weight (lbs.)	648	743	842	941	1,190

Design and specifications subject to change without notice. Most updated spec sheets are available at www.turboairinc.com.

Actual shipping weight may differ due to extra packing materials for product protection.

* Depth does not include 1-1/4" for rear spacers. † Height does not include 5/8" for bolt height.

■ **WARRANTY: 2 Year Parts and Labor Warranty, 5 Year Compressor Warranty**

VERTICAL AIR CURTAINS NATURAL Refrigerant

Self-Cleaning Condenser Equipped Units

■ **Self-Cleaning Condenser (Patented)**

The accumulation of dust in the condenser can cause the failure or breakdown of refrigerators. Refrigerators run normally until they reach a certain level of accumulation. At some point, when they are over the limit, their performance drops quickly resulting in damage to, or disposal of the stored products inside. The Self-Cleaning Condenser device keeps the condenser clean and prevents system failure by automatically brushing daily.

■ **Hydrocarbon refrigerants (R-290)**

With innovative and eco-friendly technology, Turbo Air brings you hydrocarbon refrigerators designed to meet DOE's Energy Conservation Standards in 2017 and to use EPA's SNAP Program approved HC refrigerants. Hydrocarbon refrigerants do not deplete the ozone layer and have very low contribution to global warming (ODP-0, GWP-3).

■ **Modern design**

By harmonizing curvature and rigidity, our modern style product designs are user-friendly while maintaining the highest product visibility and aesthetics. The glass front shield optimize the merchandiser's display effects of fresh salads, sandwiches, desserts and beverages.

■ **Designed to enhance impulsive sales**

Ideal for eye-catching displays and convenient access with fast service in high traffic area.

■ **Black coated galvanized steel interior**

■ **Black coated galvanized steel solid shelves**

■ **Energy saving night curtain standard**

■ **Standard back-guard improves airflow**

■ **Foamed with polyurethane, high-density cell insulation (CFC free)**

■ **Perforated interior back wall and top for improved airflow**

■ **Front air intake and rear air discharge**

■ **LED interior lighting under each shelf**



Self-Cleaning Condenser
Maintenance-free
during warranty period

TOM-72EB-A-N

TOM-36EB-A-N

■ **Standard features**

- Simple plug-in installation
- Patented self-contained system, no plumbing required
- Solar powered digital thermometer
- Digital electronic thermostat with defrost control
- Price tag channel
- Bolt height adjustable up to 2-3/4"

■ **Optional features**

- Security cover available
- Leveling leg available
- Casters available

- **Recommended operating conditions**

TOM models are designed to operate in an environment where temperature & humidity do not exceed 75°F and 55% respectively. Units should not be installed near HVAC vents, fans or doorways that will disrupt the air curtain and compromise the function of the cabinet. Air curtain models will run most efficiently when completely loaded with product. When used as a built-in, required clearance for the rear is 4" and the top is 5".

TOM-E MODELS SPECIFICATIONS

ELECTRICAL DATA	TOM-36EB-A-N	TOM-48EB-A-N	TOM-60EB-A-N	TOM-72EB-A-N
Voltage	115/60/1	115/60/1	115/60/1	220/60/1
Plug Type	Ⓢ NEMA 5-20P	Ⓢ NEMA 5-20P	Ⓢ NEMA 5-20P	Ⓢ NEMA 6-20P
Full Load Amp.	15.5	15.5	15.5	18
Compressor HP	3/4 x 2	3/4 x 2	3/4 x 2	3/4 x 4
Refrigerant	R-290	R-290	R-290	R-290
DIMENSIONAL DATA				
Net Capacity (cu. ft.)	16.5	22.6	28.6	34.7
Ext. Dimension (L x D [*] x H [†]) (in.)	36 x 29 ^{1/2} x 80 ^{1/2}	48 x 29 ^{1/2} x 80 ^{1/2}	60 x 29 ^{1/2} x 80 ^{1/2}	72 x 29 ^{1/2} x 80 ^{1/2}
# of Shelves	4	4	4	8
Shelf Size (L x D) (in.)	32 ^{3/4} x 15 ^{1/2}	44 ^{3/4} x 15 ^{1/2}	56 ^{3/4} x 15 ^{1/2}	34 ^{1/4} x 15 ^{1/2}
Net Weight (lbs.)	498	573	648	723
Gross Weight (lbs.)	648	743	842	941

Design and specifications subject to change without notice. Most updated spec sheets are available at www.turboairinc.com.

Actual shipping weight may differ due to extra packing materials for product protection.

* Depth does not include 1-1/4" for rear spacers. † Height does not include 5/8" for bolt height.

■ **WARRANTY: 2 Year Parts and Labor Warranty, 5 Year Compressor Warranty**

VERTICAL AIR CURTAINS **NATURAL Refrigerant**

Self-Cleaning Condenser Equipped Units

Self-Cleaning Condenser (Patented)

The accumulation of dust in the condenser can cause the failure or breakdown of refrigerators. Refrigerators run normally until they reach a certain level of accumulation. At some point, when they are over the limit, their performance drops quickly resulting in damage to, or disposal of the stored products inside. The Self-Cleaning Condenser device keeps the condenser clean and prevents system failure by automatically brushing daily.

Hydrocarbon refrigerants (R-290)

With innovative and eco-friendly technology, Turbo Air brings you hydrocarbon refrigerators designed to meet DOE's Energy Conservation Standards in 2017 and to use EPA's SNAP Program approved HC refrigerants. Hydrocarbon refrigerants do not deplete the ozone layer and have very low contribution to global warming (ODP-0, GWP-3).

Modern design

By harmonizing curvature and rigidness, our modern style product designs are user-friendly while maintaining the highest product visibility and aesthetics. The glass front shield optimize the merchandiser's display effects of fresh salads, sandwiches, desserts and beverages.

Designed to enhance impulsive sales

Ideal for eye-catching displays and convenient access with fast service in high traffic area.

White coated galvanized steel interior

White coated galvanized steel solid shelves

Energy saving night curtain standard

Standard back-guard improves airflow

Foamed with polyurethane, high-density cell insulation (CFC free)

Perforated interior back wall and top for improved airflow

Front air intake and rear air discharge

LED interior lighting under each shelf

LED advertising panel



TOM-75SEW-N

Self-Cleaning Condenser
Maintenance-free during warranty period

TOM-50SEB-N

Standard features

- Simple plug-in installation
- Patented self-contained system, no plumbing required
- Solar powered digital thermometer
- Digital electronic thermostat with defrost control
- White and black colors come standard
- Lead time applies

Optional features

- Price tag channel available
- Leveling leg available
- Casters available

Recommended operating conditions

TOM models are designed to operate in an environment where temperature & humidity do not exceed 75°F and 55% respectively. Units should not be installed near HVAC vents, fans or doorways that will disrupt the air curtain and compromise the function of the cabinet. Air curtain models will run most efficiently when completely loaded with product. When used as a built-in, required clearance for the rear is 4" and the top is 5".

TOM-SE MODELS SPECIFICATIONS

ELECTRICAL DATA	TOM-40SEW(B)-N	TOM-50SEW(B)-N	TOM-60SEW(B)-N	TOM-75SEW(B)-N	TOM-96SEW(B)-N
Voltage	115/60/1	115/60/1	115/60/1	220/60/1	220/60/1
Plug Type	Ⓢ NEMA 5-20P	Ⓢ NEMA 5-20P	Ⓢ NEMA 5-20P	Ⓢ NEMA 6-20P	Ⓢ NEMA 6-20P
Full Load Amp.	15.5	15.5	15.5	18	18
Compressor HP	3/4 x 2	3/4 x 2	3/4 x 2	3/4 x 4	3/4 x 4
Refrigerant	R-290	R-290	R-290	R-290	R-290
DIMENSIONAL DATA					
Net Capacity (cu. ft.)	16.1	21.3	26.5	32.2	42.6
Ext. Dimension (L x D x H†) (in.)	39 7/8 x 25 3/4 x 80 1/4	51 5/8 x 25 3/4 x 80 1/4	64 x 25 3/4 x 80 1/4	76 1/2 x 25 3/4 x 80 1/4	100 1/8 x 25 3/4 x 80 1/4
# of Shelves	4	4	4	8	8
Shelf Size (L x D) (in.)	36 1/2 x 12	48 3/8 x 12	60 3/4 x 12	36 1/2 x 12	48 3/8 x 12
Net Weight (lbs.)	512	590	668	980	1,136
Gross Weight (lbs.)	642	733	824	1,220	1,402

Design and specifications subject to change without notice. Most updated spec sheets are available at www.turboairinc.com.

Actual shipping weight may differ due to extra packing materials for product protection.

* Depth does not include 1-1/4" for rear spacers. † Height does not include 5/8" for bolt height.

WARRANTY: 2 Year Parts and Labor Warranty, 5 Year Compressor Warranty

VERTICAL AIR CURTAINS NATURAL Refrigerant

Self-Cleaning Condenser Equipped Units

■ **Self-Cleaning Condenser (Patented)**

The accumulation of dust in the condenser can cause the failure or breakdown of refrigerators. Refrigerators run normally until they reach a certain level of accumulation. At some point, when they are over the limit, their performance drops quickly resulting in damage to, or disposal of the stored products inside. The Self-Cleaning Condenser device keeps the condenser clean and prevents system failure by automatically brushing daily.

■ **Hydrocarbon refrigerants (R-290)**

With innovative and eco-friendly technology, Turbo Air brings you hydrocarbon refrigerators designed to meet DOE's Energy Conservation Standards in 2017 and to use EPA's SNAP Program approved HC refrigerants. Hydrocarbon refrigerants do not deplete the ozone layer and have very low contribution to global warming (ODP-0, GWP-3).

■ **Modern design**

By harmonizing curvature and rigidity, our modern style product designs are user-friendly while maintaining the highest product visibility and aesthetics. The glass front shield optimize the merchandiser's display effects of fresh salads, sandwiches, desserts and beverages.

■ **Designed to enhance impulsive sales**

Ideal for eye-catching displays and convenient access with fast service in high traffic area.

■ **White coated galvanized steel interior**

■ **White coated galvanized steel solid shelves**

■ **Energy saving night curtain standard**

■ **Standard back-guard improves airflow**

■ **Foamed with polyurethane, high-density cell insulation (CFC free)**

■ **Perforated interior back wall and top for improved airflow**

■ **Front air intake and rear air discharge**

■ **LED interior lighting under each shelf**

■ **LED advertising panel**



Self-Cleaning Condenser
Maintenance-free during warranty period
TOM-50MSEW-N

TOM-25MSEB-N

■ **Standard features**

- Simple plug-in installation
- Patented self-contained system, no plumbing required
- Solar powered digital thermometer
- Digital electronic thermostat with defrost control
- White and black colors come standard
- Lead time applies

■ **Optional features**

- Price tag channel available
- Leveling leg available
- Casters available

- **Recommended operating conditions**

TOM models are designed to operate in an environment where temperature & humidity do not exceed 75°F and 55% respectively. Units should not be installed near HVAC vents, fans or doorways that will disrupt the air curtain and compromise the function of the cabinet. Air curtain models will run most efficiently when completely loaded with product. When used as a built-in, required clearance for the rear is 4" and the top is 5".

TOM-MSE MODELS SPECIFICATIONS

ELECTRICAL DATA	TOM-25MSEW(B)-N	TOM-40MSEW(B)-N	TOM-50MSEW(B)-N	TOM-60MSEW(B)-N	TOM-75MSEW(B)-N
Voltage	115/60/1	115/60/1	115/60/1	115/60/1	115/60/1
Plug Type	Ⓢ NEMA 5-15P	Ⓢ NEMA 5-15P	Ⓢ NEMA 5-20P	Ⓢ NEMA 5-20P	Ⓢ NEMA 5-20P
Full Load Amp.	8	8	15.5	15.5	15.5
Compressor HP	3/4	3/4	3/4 x 2	3/4 x 2	3/4 x 2
Refrigerant	R-290	R-290	R-290	R-290	R-290
DIMENSIONAL DATA					
Net Capacity (cu. ft.)	7.0	10.4	13.8	17.2	20.9
Ext. Dimension (L x D x H†) (in.)	28 x 25 ³ / ₄ x 60 ³ / ₄	39 ⁷ / ₈ x 25 ³ / ₄ x 60 ³ / ₄	51 ⁵ / ₈ x 25 ³ / ₄ x 60 ³ / ₄	64 x 25 ³ / ₄ x 60 ³ / ₄	76 ¹ / ₂ x 25 ³ / ₄ x 60 ³ / ₄
# of Shelves	3	3	3	3	6
Shelf Size (L x D) (in.)	24 ³ / ₄ x 12	36 ¹ / ₂ x 12	48 ³ / ₈ x 12	60 ³ / ₄ x 12	36 ¹ / ₂ x 12
Net Weight (lbs.)	359	421	463	505	812
Gross Weight (lbs.)	461	521	567	607	992

Design and specifications subject to change without notice. Most updated spec sheets are available at www.turboairinc.com.

Actual shipping weight may differ due to extra packing materials for product protection.

* Depth does not include 1-1/4" for rear spacers. † Height does not include 5/8" for bolt height.

■ **WARRANTY: 2 Year Parts and Labor Warranty, 5 Year Compressor Warranty**

ISLAND DISPLAY CASES NATURAL Refrigerant

Self-Cleaning Condenser Equipped Units

■ **Self-Cleaning Condenser (Patented)**

The accumulation of dust in the condenser causes the failure or breakdown of refrigerators. Refrigerators run normally until they reach a certain level of accumulation. At some point, when they are over the limit, their performance drops quickly resulting in damage to, or disposal of the stored products in refrigerators. The Self-Cleaning Condenser device keeps the condenser clean and prevents system failure by automatically brushing daily.

■ **Hydrocarbon refrigerant (R-290)**

With innovative and eco-friendly technology, Turbo Air brings you hydrocarbon refrigerators designed to meet DOE's Energy Conservation Standards in 2017 and to use EPA's SNAP Program approved HC refrigerants. Hydrocarbon refrigerants do not deplete the ozone layer and have very low contribution to global warming (ODP-0, GWP-3).

■ **Modern design**

By harmonizing curvature and rigidness, our modern style product designs are user-friendly while maintaining the highest product visibility and aesthetics. The glass front shield optimizes the merchandiser's display effects of fresh salads, sandwiches, desserts and beverages.

■ **Designed to enhance impulsive sales**

Ideal for eye-catching displays and convenient access with fast service in high traffic area.

■ **LED lighting on top panel and canopy**

Brighter and longer lasting LED lights provide attractive, enhanced illumination compared to fluorescents. It saves energy by producing less heat, while maximizing the visibility in the display area.

■ **5mm thick durable clear PC (polycarbonate) product stopper**

■ **Simple plug-in installation**

■ **Patented self-contained system, no plumbing required**

■ **Stainless steel interior standard including back wall and deck pans**

■ **Digital electronic thermostat with defrost control**

■ **Stainless steel color option available**

■ **Standard features**

- Standard color comes in black only
- Price tag rails
- Lead time applies



TIOM-48SS-N

* Please allow extra lead time for TIOM models.



Self-Cleaning Condenser Maintenance-free during warranty period

TIOM-36SB-N

■ **Optional features**

- Leveling leg available
- Casters available

- **Recommended operating conditions**

TIOM models are designed to operate in an environment where temperature & humidity do not exceed 75°F and 55% respectively. Units should not be installed near HVAC vents, fans or doorways that will disrupt the air curtain and compromise the function of the cabinet. Air curtain models will run most efficiently when completely loaded with product.

TIOM MODELS SPECIFICATIONS

ELECTRICAL DATA	TIOM-36SB(S)-N	TIOM-48SB(S)-N
Voltage	220/60/1	220/60/1
Plug Type	Ⓢ NEMA L6-20P	Ⓢ NEMA L6-20P
Full Load Amp.	8.7	8.7
Compressor HP	3/4 x 2	3/4 x 2
Refrigerant	R-290	R-290
DIMENSIONAL DATA		
Net Capacity (cu. ft.)	14.4	17.6
Ext. Dimension (L x D x H*) (in.)	38 ⁵ / ₈ x 48 x 65 ¹ / ₄	50 ³ / ₈ x 48 x 65 ¹ / ₄
# of Shelves (Size (L x D) (in.))	2 (36 ¹ / ₈ x 9), 4 (36 ¹ / ₈ x 10)	2 (48 x 9), 4 (48 x 10)
Net Weight (lbs.)	507	594
Gross Weight (lbs.)	630	747

Design and specifications subject to change without notice. Most updated spec sheets are available at www.turboairinc.com.

Actual shipping weight may differ due to extra packing materials for product protection.

* Height does not include 5/8" for bolt height.

■ **WARRANTY: 2 Year Parts and Labor Warranty, 5 Year Compressor Warranty**

ISLAND DISPLAY CASES NATURAL Refrigerant

Self-Cleaning Condenser Equipped Units

■ **Self-Cleaning Condenser (Patented)**

The accumulation of dust in the condenser causes the failure or breakdown of refrigerators. Refrigerators run normally until they reach a certain level of accumulation. At some point, when they are over the limit, their performance drops quickly resulting in damage to, or disposal of the stored products in refrigerators. The Self-Cleaning Condenser device keeps the condenser clean and prevents system failure by automatically brushing daily.

■ **Hydrocarbon refrigerant (R-290)**

With innovative and eco-friendly technology, Turbo Air brings you hydrocarbon refrigerators designed to meet DOE's Energy Conservation Standards in 2017 and to use EPA's SNAP Program approved HC refrigerants. Hydrocarbon refrigerants do not deplete the ozone layer and have very low contribution to global warming (ODP-0, GWP-3).

■ **Modern design**

By harmonizing curvature and rigidness, our modern style product designs are user-friendly while maintaining the highest product visibility and aesthetics. The glass front shield optimize the merchandiser's display effects of fresh salads, sandwiches, desserts and beverages.

■ **Designed to enhance impulsive sales**

Ideal for eye-catching displays and convenient access with fast service in high traffic area.

■ **LED lighting on top panel and canopy**

Brighter and longer lasting LED lights provide attractive, enhanced illumination compared to fluorescents. It saves energy by producing less heat, while maximizing the visibility in the display area.

■ **ABS bump guard liners**

■ **5mm thick durable clear PC (polycarbonate) product stopper**

■ **Simple plug-in installation**

■ **Patented self-contained system, no plumbing required**

■ **Digital electronic thermostat with defrost control**

■ **Stainless steel color option available (only TIOM-48RRS-N)**

■ **Standard features**

- Standard color comes in black only
- Price tag rails
- Lead time applies



TIOM-48RRB-N

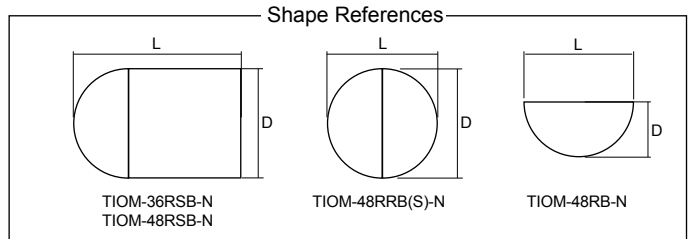

■ **Optional features**

- Leveling leg available
- Casters available

- **Recommended operating conditions**

TIOM models are designed to operate in an environment where temperature & humidity do not exceed 75°F and 55% respectively. Units should not be installed near HVAC vents, fans or doorways that will disrupt the air curtain and compromise the function of the cabinet. Air curtain models will run most efficiently when completely loaded with product.

TIOM MODELS SPECIFICATIONS

ELECTRICAL DATA	TIOM-48RB-N	TIOM-48RRB(S)-N	TIOM-36RSB-N	TIOM-48RSB-N
Voltage	220/60/1	220/60/1	220/60/1	220/60/1
Plug Type	Ⓢ NEMA L6-20P	Ⓢ NEMA L6-20P	Ⓢ NEMA L6-20P	Ⓢ NEMA L6-20P
Full Load Amp.	7.74	15.48	16.43	16.43
Compressor HP	3/4 x 2	3/4 x 4	3/4 x 4	3/4 x 4
Refrigerant	R-290	R-290	R-290	R-290
DIMENSIONAL DATA				
Net Capacity (cu. ft.)	5.6	11.2	20	23.2
Ext. Dimension (L x D x H*) (in.)	48 x 25 1/2 x 65	48 x 48 x 65	48 x 61 3/4 x 65	48 x 73 5/8 x 65
# of Tiers	3	3	3	3
Net Weight (lbs.)	397	706	816	904
Gross Weight (lbs.)	562	853	1,225	1,333

Design and specifications subject to change without notice. Most updated spec sheets are available at www.turboairinc.com.

Actual shipping weight may differ due to extra packing materials for product protection.

* Height does not include 5/8" for bolt height.

■ **WARRANTY: 2 Year Parts and Labor Warranty, 5 Year Compressor Warranty**

ISLAND DISPLAY CASES NATURAL Refrigerant

Self-Cleaning Condenser Equipped Units

Self-Cleaning Condenser (Patented)

The accumulation of dust in the condenser causes the failure or breakdown of refrigerators. Refrigerators run normally until they reach a certain level of accumulation. At some point, when they are over the limit, their performance drops quickly resulting in damage to, or disposal of the stored products in refrigerators. The Self-Cleaning Condenser device keeps the condenser clean and prevents system failure by automatically brushing daily.

Hydrocarbon refrigerant (R-290)

With innovative and eco-friendly technology, Turbo Air brings you hydrocarbon refrigerators designed to meet DOE's Energy Conservation Standards in 2017 and to use EPA's SNAP Program approved HC refrigerants. Hydrocarbon refrigerants do not deplete the ozone layer and have very low contribution to global warming (ODP-0, GWP-3).

Modern design

By harmonizing curvature and rigidity, our modern style product designs are user-friendly while maintaining the highest product visibility and aesthetics. The glass front shield optimize the merchandiser's display effects of fresh salads, sandwiches, desserts and beverages.

Designed to enhance impulsive sales

Ideal for eye-catching displays and convenient access with fast service in high traffic area.

LED lighting on top panel and canopy

Brighter and longer lasting LED lights provide attractive, enhanced illumination compared to fluorescents. It saves energy by producing less heat, while maximizing the visibility in the display area.

ABS bump guard liners

5mm thick durable clear PC (polycarbonate) product stopper

Simple plug-in installation

Patented self-contained system, no plumbing required

Digital electronic thermostat with defrost control

Stainless steel color option available

Standard features

- Standard color comes in black only
- Price tag rails
- Lead time applies



TIOM-20RSRS-N

TIOM-48RSRB-N

Self-Cleaning Condenser
Maintenance-free during warranty period

* Please allow extra lead time for TIOM models.

Shape References

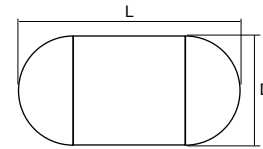

TIOM-20RSRB(S)-N / TIOM-36RSRB(S)-N / TIOM-48RSRB(S)-N

Optional features

- Leveling leg available
- Casters available

Recommended operating conditions

TIOM models are designed to operate in an environment where temperature & humidity do not exceed 75°F and 55% respectively. Units should not be installed near HVAC vents, fans or doorways that will disrupt the air curtain and compromise the function of the cabinet. Air curtain models will run most efficiently when completely loaded with product.

TIOM MODELS SPECIFICATIONS

ELECTRICAL DATA	TIOM-20RSRB(S)-N	TIOM-36RSRB(S)-N	TIOM-48RSRB(S)-N
Voltage	220/60/1	220/60/1	220/60/1
Plug Type	Ⓢ NEMA L6-30P	Ⓢ NEMA L6-30P	Ⓢ NEMA L6-30P
Full Load Amp.	20.14	24.17	24.17
Compressor HP	3/4 x 5	3/4 x 6	3/4 x 6
Refrigerant	R-290	R-290	R-290
DIMENSIONAL DATA			
Net Capacity (cu. ft.)	19.2	25.6	28.8
Ext. Dimension (L x D x H*) (in.)	48 x 67 ^{7/8} x 65	48 x 84 ^{1/8} x 65	48 x 96 x 65
# of Tiers	3	3	3
Net Weight (lbs.)	938	1,125	1,212
Gross Weight (lbs.)	1,230	1,512	1,642

Design and specifications subject to change without notice. Most updated spec sheets are available at www.turboairinc.com.

Actual shipping weight may differ due to extra packing materials for product protection.

* Height does not include 1-1/8" for caster height.

WARRANTY: 2 Year Parts and Labor Warranty, 5 Year Compressor Warranty

ISLAND DISPLAY CASES **NATURAL Refrigerant**

Self-Cleaning Condenser Equipped Units

- **Self-Cleaning Condenser (Patented)**
 The accumulation of dust in the condenser causes the failure or breakdown of refrigerators. Refrigerators run normally until they reach a certain level of accumulation. At some point, when they are over the limit, their performance drops quickly resulting in damage to, or disposal of the stored products in refrigerators. The Self-Cleaning Condenser device keeps the condenser clean and prevents system failure by automatically brushing daily.
- **Hydrocarbon refrigerant (R-290)**
 With innovative and eco-friendly technology, Turbo Air brings you hydrocarbon refrigerators designed to meet DOE's Energy Conservation Standards in 2017 and to use EPA's SNAP Program approved HC refrigerants. Hydrocarbon refrigerants do not deplete the ozone layer and have very low contribution to global warming (ODP-0, GWP-3).
- **Modern design**
 By harmonizing curvature and rigidity, our modern style product designs are user-friendly while maintaining the highest product visibility and aesthetics. The glass front shield optimize the merchandiser's display effects of fresh salads, sandwiches, desserts and beverages.
- **Designed to enhance impulsive sales**
 Ideal for eye-catching displays and convenient access with fast service in high traffic area.
- **LED lighting on top panel and canopy**
 Brighter and longer lasting LED lights provide attractive, enhanced illumination compared to fluorescents. It saves energy by producing less heat, while maximizing the visibility in the display area.
- **Tempered glass product stopper**
- **Simple plug-in installation**
- **Patented self-contained system, no plumbing required**
- **Digital electronic thermostat with defrost control**
- **Standard features**

 - Standard color comes in black only
 - Price tag rails
 - Lead time applies
- **Optional features**

 - Leveling leg available
 - Casters available



TIOM-48CSB-N

TIOM-48CCB-N

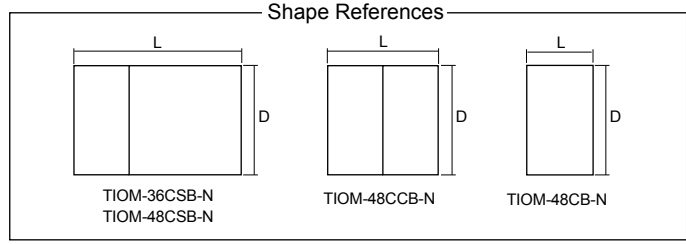

- **Recommended operating conditions**
 TIOM models are designed to operate in an environment where temperature & humidity do not exceed 75°F and 55% respectively. Units should not be installed near HVAC vents, fans or doorways that will disrupt the air curtain and compromise the function of the cabinet. Air curtain models will run most efficiently when completely loaded with product.

TIOM MODELS SPECIFICATIONS

ELECTRICAL DATA	TIOM-48CB-N	TIOM-48CCB-N	TIOM-36CSB-N	TIOM-48CSB-N
Voltage	220/60/1	220/60/1	220/60/1	220/60/1
Plug Type	③ NEMA L6-20P	③ NEMA L6-20P	③ NEMA L6-20P	③ NEMA L6-20P
Full Load Amp.	7.8	15.5	16.5	16.5
Compressor HP	3/4 x 2	3/4 x 4	3/4 x 4	3/4 x 4
Refrigerant	R-290	R-290	R-290	R-290
DIMENSIONAL DATA				
Net Capacity (cu. ft.)	11.9	23.7	30.1	36.0
Ext. Dimension (L x D x H*) (in.)	47 1/8 x 25 3/4 x 64 1/2	47 1/8 x 48 3/8 x 64 1/2	62 x 47 1/8 x 64 1/2	73 7/8 x 47 1/8 x 64 1/2
# of Tiers	3	3	3	3
Net Weight (lbs.)	397	706	816	904
Gross Weight (lbs.)	562	853	1,225	1,333

Design and specifications subject to change without notice. Most updated spec sheets are available at www.turboairinc.com.
 Actual shipping weight may differ due to extra packing materials for product protection.
 * Height does not include 1-1/8" for caster height.

■ **WARRANTY: 2 Year Parts and Labor Warranty, 5 Year Compressor Warranty**

ISLAND DISPLAY CASES NATURAL Refrigerant

Self-Cleaning Condenser Equipped Units

■ **Self-Cleaning Condenser (Patented)**

The accumulation of dust in the condenser causes the failure or breakdown of refrigerators. Refrigerators run normally until they reach a certain level of accumulation. At some point, when they are over the limit, their performance drops quickly resulting in damage to, or disposal of the stored products in refrigerators. The Self-Cleaning Condenser device keeps the condenser clean and prevents system failure by automatically brushing daily.

■ **Hydrocarbon refrigerant (R-290)**

With innovative and eco-friendly technology, Turbo Air brings you hydrocarbon refrigerators designed to meet DOE's Energy Conservation Standards in 2017 and to use EPA's SNAP Program approved HC refrigerants. Hydrocarbon refrigerants do not deplete the ozone layer and have very low contribution to global warming (ODP-0, GWP-3).

■ **Modern design**

By harmonizing curvature and rigidity, our modern style product designs are user-friendly while maintaining the highest product visibility and aesthetics. The glass front shield optimize the merchandiser's display effects of fresh salads, sandwiches, desserts and beverages.

■ **Designed to enhance impulsive sales**

Ideal for eye-catching displays and convenient access with fast service in high traffic area.

■ **LED lighting on top panel and canopy**

Brighter and longer lasting LED lights provide attractive, enhanced illumination compared to fluorescents. It saves energy by producing less heat, while maximizing the visibility in the display area.

■ **Tempered glass product stopper**

■ **Simple plug-in installation**

■ **Patented self-contained system, no plumbing required**

■ **Digital electronic thermostat with defrost control**

■ **Standard features**

- Standard color comes in black only
- Price tag rails
- Lead time applies

■ **Optional features**

- Leveling leg available
- Casters available



Self-Cleaning Condenser
Maintenance-free during warranty period

TIOM-24CSCB-N

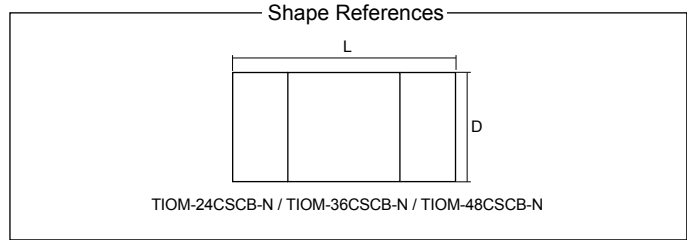

- **Recommended operating conditions**

TIOM models are designed to operate in an environment where temperature & humidity do not exceed 75°F and 55% respectively. Units should not be installed near HVAC vents, fans or doorways that will disrupt the air curtain and compromise the function of the cabinet. Air curtain models will run most efficiently when completely loaded with product.

TIOM MODELS SPECIFICATIONS

ELECTRICAL DATA	TIOM-24CSCB-N	TIOM-36CSCB-N	TIOM-48CSCB-N
Voltage	220/60/1	220/60/1	220/60/1
Plug Type	☺ NEMA L6-30P	☺ NEMA L6-30P	☺ NEMA L6-30P
Full Load Amp.	25.2	25.2	25.2
Compressor HP	3/4 x 6	3/4 x 6	3/4 x 6
Refrigerant	R-290	R-290	R-290
DIMENSIONAL DATA			
Net Capacity (cu. ft.)	35.01	41.9	47.9
Ext. Dimension (L x D x H*) (in.)	72 ³ / ₈ x 47 ¹ / ₈ x 64 ¹ / ₂	84 ⁵ / ₈ x 47 ¹ / ₈ x 64 ¹ / ₂	96 ¹ / ₂ x 47 ¹ / ₈ x 64 ¹ / ₂
# of Tiers	3	3	3
Net Weight (lbs.)	1,058	1,125	1,212
Gross Weight (lbs.)	1,321	1,512	1,642

Design and specifications subject to change without notice. Most updated spec sheets are available at www.turboairinc.com.

Actual shipping weight may differ due to extra packing materials for product protection.

* Height does not include 1-1/8" for caster height.

■ **WARRANTY: 2 Year Parts and Labor Warranty, 5 Year Compressor Warranty**

DIRECT COOLING TYPE DELI CASES NATURAL Refrigerant

Self-Cleaning Condenser Equipped Units

Self-Cleaning Condenser (Patented)

The accumulation of dust in the condenser can cause the failure or breakdown of refrigerators. Refrigerators run normally until they reach a certain level of accumulation. At some point, when they are over the limit, their performance drops quickly resulting in damage to, or disposal of the stored products inside. The Self-Cleaning Condenser device keeps the condenser clean and prevents system failure by automatically brushing daily.

Hydrocarbon refrigerants (R-290)

With innovative and eco-friendly technology, Turbo Air brings you hydrocarbon refrigerators designed to meet DOE's Energy Conservation Standards in 2017 and to use EPA's SNAP Program approved HC refrigerants. Hydrocarbon refrigerants do not deplete the ozone layer and have very low contribution to global warming (ODP-0, GWP-3).

Attractive, elegant, glass sided Euro design

Curved tempered front glass and minimal frame provide full product visibility to optimize display effects. Its elegant contemporary euro design and luxurious colored case will not only enhance any store atmosphere but also will keep product presentation at its best and most beautiful.

High-density polyurethane insulation

The entire cabinet structure is foamed-in-place using high density, CFC free polyurethane insulation.

Low-E coated double pane glass is tempered for safety

Easy access control panel

Sliding rear doors for product loading & unloading

Heavy duty, white PE coated wire shelves

Cantilever wired shelves adjustable up and down, tilted

Stainless steel floor and airflow grille

Rear access to compressor compartment for quick and easy service



TCDD-96H-W-N

Self-Cleaning Condenser
Maintenance-free
during warranty period

TCDD-72H-B-N

Refrigerated deli case holds avg. 33°F ~ 41°F for fresher products

Standard features

- Anti-corrosion coated evaporator
- No plumbing required
- White and black colors come standard
- Safety shielded LED interior lighting
- Solar powered digital thermometer
- Digital electronic thermostat with defrost control
- Hot gas defrost system

Optional features

- Leveling leg available
- Casters available

Recommended operating conditions

TCDD models are designed to operate in an environment where temperature & humidity do not exceed 75°F and 55% respectively.

TCDD MODELS SPECIFICATIONS

ELECTRICAL/DIMENSIONAL DATA	TCDD-36H-W(B)-N	TCDD-48H-W(B)-N
Voltage	115/60/1	115/60/1
Plug Type	① NEMA 5-15P	① NEMA 5-15P
Full Load Amp.	7.0	7.0
Compressor HP	1/3	1/3
Refrigerant	R-290	R-290
Net Capacity (cu. ft.)	12.1	16.2
Ext. Dimension (L x D x H*) (in.)	36 ¹ / ₂ x 30 x 49 ⁷ / ₈	48 ¹ / ₂ x 30 x 49 ⁷ / ₈
# of Shelves	2	2
Shelf Size (L x D) (in.)	32 ³ / ₈ x 15, 32 ³ / ₈ x 16 ⁷ / ₈	44 ³ / ₈ x 15, 44 ³ / ₈ x 16 ⁷ / ₈
Net / Gross Weight (lbs.)	397 / 492	461 / 580

ELECTRICAL/DIMENSIONAL DATA	TCDD-72H-W(B)-N	TCDD-96H-W(B)-N
Voltage	115/60/1	115/60/1
Plug Type	① NEMA 5-15P	① NEMA 5-15P
Full Load Amp.	7.8	7.8
Compressor HP	3/4	3/4
Refrigerant	R-290	R-290
Net Capacity (cu. ft.)	24.7	33.2
Ext. Dimension (L x D x H*) (in.)	72 ¹ / ₂ x 30 x 49 ⁷ / ₈	96 ¹ / ₂ x 30 x 49 ⁷ / ₈
# of Shelves	2	4
Shelf Size (L x D) (in.)	68 ³ / ₈ x 15, 68 ³ / ₈ x 16 ⁷ / ₈	46 ¹ / ₈ x 15, 46 ¹ / ₈ x 16 ⁷ / ₈
Net / Gross Weight (lbs.)	589 / 747	908 / 1,102

Design and specifications subject to change without notice. Most updated spec sheets are available at www.turboairinc.com.

Actual shipping weight may differ due to extra packing materials for product protection.

* Height does not include 5/8" for bolt height.

WARRANTY: 2 Year Parts and Labor Warranty, 5 Year Compressor Warranty

CURVED GLASS BAKERY CASES NATURAL Refrigerant

Self-Cleaning Condenser Equipped Units

Self-Cleaning Condenser (Patented)

The accumulation of dust in the condenser can cause the failure or breakdown of refrigerators. Refrigerators run normally until they reach a certain level of accumulation. At some point, when they are over the limit, their performance drops quickly resulting in damage to, or disposal of the stored products inside. The Self-Cleaning Condenser device keeps the condenser clean and prevents system failure by automatically brushing daily (except Dry cases).

Hydrocarbon refrigerants (R-290)

With innovative and eco-friendly technology, Turbo Air brings you hydrocarbon refrigerators designed to meet DOE's Energy Conservation Standards in 2017 and to use EPA's SNAP Program approved HC refrigerants. Hydrocarbon refrigerants do not deplete the ozone layer and have very low contribution to global warming (ODP-0, GWP-3) (except Dry cases).

Attractive, elegant, glass sided Euro design

Curved tempered front glass and minimal frame provide full product visibility to optimize display effects. Its elegant contemporary euro design and luxurious colored case will not only enhance any store atmosphere but also will keep product presentation at its best and most beautiful.

High-density polyurethane insulation

The entire cabinet structure is foamed-in-place using high density, CFC free polyurethane insulation.

Low-E coated double pane glass is tempered for safety

Heavy duty, white PE coated wire shelves

Cantilever wired shelves adjustable up and down, tilted

Stainless steel floor and airflow grille

Sliding rear doors for product loading & unloading

Rear access to compressor compartment for quick and easy service (except Dry cases)



TCGB-48-W-N

Self-Cleaning Condenser
Maintenance-free
during warranty period

TCGB-60CO-B-N

Refrigerated bakery case holds avg. 33°F ~ 41°F for fresher bakery products (except Dry cases)

Standard features

- No plumbing required
- White and black colors come standard
- Safety shielded LED interior lighting
- Solar powered digital thermometer (except Dry cases)
- Digital electronic thermostat with defrost control (except Dry cases)

Optional features

- Leveling leg available
- Casters available

Recommended operating conditions

TCGB models are designed to operate in an environment where temperature & humidity do not exceed 75°F and 55% respectively.

TCGB MODELS SPECIFICATIONS

ELECTRICAL/DIMENSIONAL DATA	TCGB-36-W(B)-N	TCGB-36DR-W(B)	TCGB-48-W(B)-N	TCGB-48DR-W(B)	TCGB-60-W(B)-N
Voltage	115/60/1	115/60/1	115/60/1	115/60/1	115/60/1
Plug Type	Ⓜ NEMA 5-15P	Ⓜ NEMA 5-15P	Ⓜ NEMA 5-15P	Ⓜ NEMA 5-15P	Ⓜ NEMA 5-15P
Full Load Amp.	7.5	0.4	7.5	0.6	8.6
Compressor HP	1/3	-	1/3	-	3/4
Refrigerant	R-290	-	R-290	-	R-290
Net Capacity (cu. ft.)	11.8	11.8	15.6	15.6	19.4
Ext. Dimension (L x D x H*) (in.)	36 1/2 x 34 1/4 x 49 7/8	36 1/2 x 34 1/4 x 49 7/8	48 1/2 x 34 1/4 x 49 7/8	48 1/2 x 34 1/4 x 49 7/8	60 1/2 x 34 1/4 x 49 7/8
# of Shelves	2	2	2	2	2
Shelf Size (L x D) (in.)	32 3/8 x 16 7/8, 32 3/8 x 18 7/8	32 3/8 x 16 7/8, 32 3/8 x 18 7/8	44 3/8 x 16 7/8, 44 3/8 x 18 7/8	44 3/8 x 16 7/8, 44 3/8 x 18 7/8	56 3/8 x 16 7/8, 56 3/8 x 18 7/8
Net / Gross Weight (lbs.)	410 / 522	324 / 437	511 / 637	373 / 551	604 / 743

ELECTRICAL/DIMENSIONAL DATA	TCGB-60DR-W(B)	TCGB-60CO-W(B)-N	TCGB-72-W(B)-N	TCGB-72DR-W(B)	TCGB-72CO-W(B)-N
Voltage	115/60/1	115/60/1	115/60/1	115/60/1	115/60/1
Plug Type	Ⓜ NEMA 5-15P	Ⓜ NEMA 5-15P	Ⓜ NEMA 5-15P	Ⓜ NEMA 5-15P	Ⓜ NEMA 5-15P
Full Load Amp.	0.7	7.5	8.6	0.7	7.5
Compressor HP	-	1/3	3/4	-	1/3
Refrigerant	-	R-290	R-290	-	R-290
Net Capacity (cu. ft.)	19.4	10.3 x 2	23.2	23.2	12.2 x 2
Ext. Dimension (L x D x H*) (in.)	60 1/2 x 34 1/4 x 49 7/8	60 1/2 x 34 1/4 x 49 7/8	72 1/2 x 34 1/4 x 49 7/8	72 1/2 x 34 1/4 x 49 7/8	72 1/2 x 34 1/4 x 49 7/8
# of Shelves	2	4	2	2	4
Shelf Size (L x D) (in.)	56 3/8 x 16 7/8, 56 3/8 x 18 7/8	(2) 26 7/8 x 16 7/8, (2) 26 7/8 x 18 7/8	68 3/8 x 16 7/8, 68 3/8 x 18 7/8	68 3/8 x 16 7/8, 68 3/8 x 18 7/8	(2) 32 7/8 x 16 7/8, (2) 32 7/8 x 18 7/8
Net / Gross Weight (lbs.)	500 / 639	622 / 761	686 / 847	582 / 743	703 / 864

Design and specifications subject to change without notice. Most updated spec sheets are available at www.turboairinc.com.

Actual shipping weight may differ due to extra packing materials for product protection.

* Height does not include 5/8" for bolt height.

WARRANTY: 2 Year Parts and Labor Warranty, 5 Year Compressor Warranty

EUROPEAN STRAIGHT DISPLAY CASES NATURAL Refrigerant

Self-Cleaning Condenser Equipped Units

■ **Self-Cleaning Condenser (Patented)**

The accumulation of dust in the condenser can cause the failure or breakdown of refrigerators. Refrigerators run normally until they reach a certain level of accumulation. At some point, when they are over the limit, their performance drops quickly resulting in damage to, or disposal of the stored products inside. The Self-Cleaning Condenser device keeps the condenser clean and prevents system failure by automatically brushing daily.

■ **Hydrocarbon refrigerants (R-290)**

With innovative and eco-friendly technology, Turbo Air brings you hydrocarbon refrigerators designed to meet DOE's Energy Conservation Standards in 2017 and to use EPA's SNAP Program approved HC refrigerants. Hydrocarbon refrigerants do not deplete the ozone layer and have very low contribution to global warming (ODP-0, GWP-3).

■ **Attractive, elegant, glass sided Euro design**

Straight tempered front glass and minimal frame provide full product visibility to optimize display effects. Its elegant contemporary euro design and luxurious colored case will not only enhance any store atmosphere but also will keep product presentation at its best and most beautiful.

■ **High-density polyurethane insulation**

The entire cabinet structure is foamed-in-place using high density, CFC free polyurethane insulation.

■ **Low-E coated double pane glass is tempered for safety**

■ **Adjustable, tempered glass shelves with stainless steel front and back edges**

■ **Stainless steel floor and airflow grille**

■ **Sliding rear doors for product loading & unloading**

■ **Rear access to compressor compartment for quick and easy service**

■ **Stainless steel color option available**



TCGB-72UF-W-N

Self-Cleaning Condenser
Maintenance-free during warranty period

TCGB-48UF-B-N

■ **Refrigerated bakery case holds avg. 33°F ~ 41°F for fresher bakery products**

■ **Standard features**

- No plumbing required
- White and black colors come standard
- Safety shielded LED interior lighting
- Solar powered digital thermometer
- Digital electronic thermostat with defrost control

- **Recommended operating conditions**

TCGB models are designed to operate in an environment where temperature & humidity do not exceed 75°F and 55% respectively.

TCGB MODELS SPECIFICATIONS

ELECTRICAL/DIMENSIONAL DATA	TCGB-36UF-W(B, S)-N	TCGB-48UF-W(B, S)-N	TCGB-60UF-W(B, S)-N
Voltage	115/60/1	115/60/1	115/60/1
Plug Type	① NEMA 5-15P	① NEMA 5-15P	① NEMA 5-15P
Full Load Amp.	7.5	7.5	8.6
Compressor HP	1/3	1/3	3/4
Refrigerant	R-290	R-290	R-290
Net Capacity (cu. ft.)	11.8	15.6	19.4
Ext. Dimension (L x D x H*) (in.)	36 1/2 x 33 1/8 x 50 1/8	48 1/2 x 33 1/8 x 50 1/8	60 1/2 x 33 1/8 x 50 1/8
# of Shelves	2	2	2
Shelf Size (L x D) (in.)	32 3/8 x 16 3/4, 32 3/8 x 18 3/4	44 3/8 x 16 3/4, 44 3/8 x 18 3/4	56 3/8 x 16 3/4, 56 3/8 x 18 3/4
Net / Gross Weight (lbs.)	439 / 551	540 / 666	637 / 776

ELECTRICAL/DIMENSIONAL DATA	TCGB-72UF-W(B, S)-N	TCGB-60UF-CO-W(B, S)-N	TCGB-72UF-CO-W(B, S)-N
Voltage	115/60/1	115/60/1	115/60/1
Plug Type	① NEMA 5-15P	① NEMA 5-15P	① NEMA 5-15P
Full Load Amp.	8.6	7.5	7.5
Compressor HP	3/4	1/3	1/3
Refrigerant	R-290	R-290	R-290
Net Capacity (cu. ft.)	23.2	10.3 x 2	12.2 x 2
Ext. Dimension (L x D x H*) (in.)	72 1/2 x 33 1/8 x 50 1/8	60 1/2 x 33 1/8 x 50 1/8	72 1/2 x 33 1/8 x 50 1/8
# of Shelves	2	4	4
Shelf Size (L x D) (in.)	68 3/8 x 16 3/4, 68 3/8 x 18 3/4	(2) 27 1/4 x 16 3/4, (2) 27 1/4 x 18 3/4	(2) 33 1/4 x 16 3/4, (2) 33 1/4 x 18 3/4
Net / Gross Weight (lbs.)	831 / 992	705 / 844	899 / 1,060

Design and specifications subject to change without notice. Most updated spec sheets are available at www.turboairinc.com.

Actual shipping weight may differ due to extra packing materials for product protection.

* Height does not include 5/8" for bolt height.

■ **WARRANTY: 2 Year Parts and Labor Warranty, 5 Year Compressor Warranty**

EUROPEAN STRAIGHT DISPLAY CASES

■ **Attractive, elegant, glass sided Euro design**

Straight tempered front glass and minimal frame provide full product visibility to optimize display effects. Its elegant contemporary euro design and luxurious colored case will not only enhance any store atmosphere but also will keep product presentation at its best and most beautiful.

■ **High-density polyurethane insulation**

The entire cabinet structure is foamed-in-place using high density, CFC free polyurethane insulation.

■ **LED interior lighting under each shelf**

■ **Low-E coated double pane glass is tempered for safety**

■ **Adjustable, tempered glass shelves with stainless steel front and back edges**

■ **Stainless steel floor**

■ **Sliding rear doors for product loading & unloading**

■ **Stainless steel color option available**

■ **Standard features**

- White and black colors come standard



TCGB-48UF-DR-S



TCGB-72UF-DR-B

TCGB MODELS SPECIFICATIONS

ELECTRICAL DATA	TCGB-36UF-DR-W(B, S)	TCGB-48UF-DR-W(B, S)	TCGB-60UF-DR-W(B, S)	TCGB-72UF-DR-W(B, S)
Voltage	115/60/1	115/60/1	115/60/1	115/60/1
Plug Type	Ⓜ NEMA 5-15P	Ⓜ NEMA 5-15P	Ⓜ NEMA 5-15P	Ⓜ NEMA 5-15P
Full Load Amp.	0.4	0.6	0.7	0.7
DIMENSIONAL DATA				
Net Capacity (cu. ft.)	11.8	15.6	19.4	23.2
Ext. Dimension (L x D x H*) (in.)	36 ¹ / ₂ x 33 ¹ / ₈ x 50 ¹ / ₈	48 ¹ / ₂ x 33 ¹ / ₈ x 50 ¹ / ₈	60 ¹ / ₂ x 33 ¹ / ₈ x 50 ¹ / ₈	72 ¹ / ₂ x 33 ¹ / ₈ x 50 ¹ / ₈
# of Shelves	2	2	2	2
Shelf Size (L x D) (in.)	32 ³ / ₈ x 16 ³ / ₄ , 32 ³ / ₈ x 18 ³ / ₄	44 ³ / ₈ x 16 ³ / ₄ , 44 ³ / ₈ x 18 ³ / ₄	56 ³ / ₈ x 16 ³ / ₄ , 56 ³ / ₈ x 18 ³ / ₄	68 ³ / ₈ x 16 ³ / ₄ , 68 ³ / ₈ x 18 ³ / ₄
Net Weight (lbs.)	353	454	534	728
Gross Weight (lbs.)	465	580	672	888

Design and specifications subject to change without notice. Most updated spec sheets are available at www.turboairinc.com.

Actual shipping weight may differ due to extra packing materials for product protection.

* Height does not include 5/8" for bolt height.

■ **WARRANTY: 2 Year Parts and Labor Warranty**

BAKERY DISPLAY CASES NATURAL Refrigerant

Self-Cleaning Condenser Equipped Units

Self-Cleaning Condenser (Patented)

The accumulation of dust in the condenser can cause the failure or breakdown of refrigerators. Refrigerators run normally until they reach a certain level of accumulation. At some point, when they are over the limit, their performance drops quickly resulting in damage to, or disposal of the stored products inside. The Self-Cleaning Condenser device keeps the condenser clean and prevents system failure by automatically brushing daily.

Hydrocarbon refrigerants (R-290)

With innovative and eco-friendly technology, Turbo Air brings you hydrocarbon refrigerators designed to meet DOE's Energy Conservation Standards in 2017 and to use EPA's SNAP Program approved HC refrigerants. Hydrocarbon refrigerants do not deplete the ozone layer and have very low contribution to global warming (ODP-0, GWP-3).

Attractive, elegant, glass sided Euro design

Straight, tempered front & side glass with minimal frame provide full product visibility to optimize display effects. Its elegant contemporary euro design and luxurious colored case will not only enhance any store atmosphere but also will keep product presentation at its best and most beautiful.

High-density polyurethane insulation

The entire cabinet structure is foamed-in-place using high density, CFC free polyurethane insulation.

Digital temperature controller

Double pane glass is tempered for safety (Front heated glass)

Adjustable, tempered glass shelf with AL front and back edges

Stainless steel airflow grille

Sliding rear doors for product loading & unloading



Self-Cleaning Condenser
Maintenance-free
during warranty period
TBP36-46NN-S



TBP36-54NN-B

Rear access to compressor compartment for quick and easy service

Stainless steel color option available

Standard features

- No plumbing required
- Safety shielded LED interior lighting
- White and black colors come standard
- 3" dia. swivel casters with locks on the rear set

Recommended operating conditions

TBP models are designed to operate in an environment where temperature & humidity do not exceed 75°F and 55% respectively.

TBP-NN MODELS SPECIFICATIONS

ELECTRICAL/DIMENSIONAL DATA	TBP36-46NN-W(B, S)	TBP48-46NN-W(B, S)	TBP60-46NN-W(B, S)
Voltage	115/60/1	115/60/1	115/60/1
Plug Type	Ⓜ NEMA 5-15P	Ⓜ NEMA 5-15P	Ⓜ NEMA 5-15P
Full Load Amp.	6	6.3	6.5
Compressor HP	1/3	3/4	3/4
Refrigerant	R-290	R-290	R-290
Net Capacity (cu. ft.)	9	12.4	15.7
Ext. Dimension (L x D x H*) (in.)	35 ³ / ₈ x 27 ¹ / ₂ x 44 ¹ / ₈	47 ¹ / ₄ x 27 ¹ / ₂ x 44 ¹ / ₈	59 x 27 ¹ / ₂ x 44 ¹ / ₈
# of Shelves	1	1	1
Shelf Size (L x D) (in.)	31 ³ / ₈ x 13	43 ¹ / ₄ x 13	55 x 13
Net / Gross Weight (lbs.)	317 / 494	383 / 582	445 / 665

ELECTRICAL/DIMENSIONAL DATA	TBP36-54NN-W(B, S)	TBP48-54NN-W(B, S)	TBP60-54NN-W(B, S)
Voltage	115/60/1	115/60/1	115/60/1
Plug Type	Ⓜ NEMA 5-15P	Ⓜ NEMA 5-15P	Ⓜ NEMA 5-15P
Full Load Amp.	6	6.5	6.8
Compressor HP	1/3	3/4	3/4
Refrigerant	R-290	R-290	R-290
Net Capacity (cu. ft.)	12.5	17.2	21.8
Ext. Dimension (L x D x H*) (in.)	35 ³ / ₈ x 27 ¹ / ₂ x 52 ¹ / ₈	47 ¹ / ₄ x 27 ¹ / ₂ x 52 ¹ / ₈	59 x 27 ¹ / ₂ x 52 ¹ / ₈
# of Shelves	2	2	2
Shelf Size (L x D) (in.)	31 ³ / ₈ x 13, 31 ³ / ₈ x 11	43 ¹ / ₄ x 13, 43 ¹ / ₄ x 11	55 x 13, 55 x 11
Net / Gross Weight (lbs.)	362 / 550	433 / 643	505 / 741

Design and specifications subject to change without notice. Most updated spec sheets are available at www.turboairinc.com.

Actual shipping weight may differ due to extra packing materials for product protection.

* Height does not include 2-1/4" for caster height.

WARRANTY: 2 Year Parts and Labor Warranty, 5 Year Compressor Warranty

BAKERY DISPLAY CASES NATURAL Refrigerant

Self-Cleaning Condenser Equipped Units

■ **Self-Cleaning Condenser (Patented)**

The accumulation of dust in the condenser can cause the failure or breakdown of refrigerators. Refrigerators run normally until they reach a certain level of accumulation. At some point, when they are over the limit, their performance drops quickly resulting in damage to, or disposal of the stored products inside. The Self-Cleaning Condenser device keeps the condenser clean and prevents system failure by automatically brushing daily.

■ **Hydrocarbon refrigerants (R-290)**

With innovative and eco-friendly technology, Turbo Air brings you hydrocarbon refrigerators designed to meet DOE's Energy Conservation Standards in 2017 and to use EPA's SNAP Program approved HC refrigerants. Hydrocarbon refrigerants do not deplete the ozone layer and have very low contribution to global warming (ODP-0, GWP-3).

■ **Attractive, elegant, glass sided Euro design**

Straight, tempered front & side glass with minimal frame provide full product visibility to optimize display effects. Its elegant contemporary euro design and luxurious colored case will not only enhance any store atmosphere but also will keep product presentation at its best and most beautiful.

■ **High-density polyurethane insulation**

The entire cabinet structure is foamed-in-place using high density, CFC free polyurethane insulation.

■ **Digital temperature controller**

■ **Double pane glass is tempered for safety**

(Front heated glass)

■ **Adjustable, tempered glass shelf with AL front and back edges**

■ **Stainless steel floor and airflow grille**

■ **Rear access to compressor compartment for quick and easy service**

■ **Stainless steel color option available**



Sliding rear doors and front glass opening
Sliding rear doors make it easily accessible and convenient to arrange products. These doors are built to withstand constant sliding open and close. The front glass opens just enough to clean the interior effortlessly.

■ **Standard features**

- Front glass door lock
- No plumbing required
- Safety shielded LED interior lighting
- White and black colors come standard
- 3" dia. swivel casters with locks on the rear set

- **Recommended operating conditions**

TBP models are designed to operate in an environment where temperature & humidity do not exceed 75°F and 55% respectively.

TBP-FN MODELS SPECIFICATIONS

ELECTRICAL/DIMENSIONAL DATA	TBP36-46FN-W(B, S)	TBP48-46FN-W(B, S)	TBP60-46FN-W(B, S)
Voltage	115/60/1	115/60/1	115/60/1
Plug Type	Ⓢ NEMA 5-15P	Ⓢ NEMA 5-15P	Ⓢ NEMA 5-15P
Full Load Amp.	6.3	6.8	7.3
Compressor HP	1/3	3/4	3/4
Refrigerant	R-290	R-290	R-290
Net Capacity (cu. ft.)	9	12.4	15.7
Ext. Dimension (L x D x H*) (in.)	35 3/8 x 27 1/2 x 44 1/8	47 1/4 x 27 1/2 x 44 1/8	59 x 27 1/2 x 44 1/8
# of Shelves	1	1	1
Shelf Size (L x D) (in.)	31 3/8 x 13	41 3/4 x 13	55 x 13
Net / Gross Weight (lbs.)	327 / 504	398 / 597	465 / 686

ELECTRICAL/DIMENSIONAL DATA	TBP36-54FN-W(B, S)	TBP48-54FN-W(B, S)	TBP60-54FN-W(B, S)
Voltage	115/60/1	115/60/1	115/60/1
Plug Type	Ⓢ NEMA 5-15P	Ⓢ NEMA 5-15P	Ⓢ NEMA 5-15P
Full Load Amp.	7.0	8.2	8.7
Compressor HP	1/3	3/4	3/4
Refrigerant	R-290	R-290	R-290
Net Capacity (cu. ft.)	12.5	17.2	21.8
Ext. Dimension (L x D x H*) (in.)	35 3/8 x 27 1/2 x 52 1/8	47 1/4 x 27 1/2 x 52 1/8	59 x 27 1/2 x 52 1/8
# of Shelves	2	2	2
Shelf Size (L x D) (in.)	31 3/8 x 13, 31 3/8 x 11	43 1/4 x 13, 43 1/4 x 11	55 x 13, 55 x 11
Net / Gross Weight (lbs.)	362 / 550	433 / 643	505 / 741

Design and specifications subject to change without notice. Most updated spec sheets are available at www.turboairinc.com.

Actual shipping weight may differ due to extra packing materials for product protection.

* Height does not include 2-1/4" for caster height.

■ **WARRANTY: 2 Year Parts and Labor Warranty, 5 Year Compressor Warranty**

DROP-IN TYPE BAKERY DISPLAY CASES NATURAL Refrigerant

Self-Cleaning Condenser Equipped Units

■ **Self-Cleaning Condenser (Patented)**

The accumulation of dust in the condenser can cause the failure or breakdown of refrigerators. Refrigerators run normally until they reach a certain level of accumulation. At some point, when they are over the limit, their performance drops quickly resulting in damage to, or disposal of the stored products inside. The Self-Cleaning Condenser device keeps the condenser clean and prevents system failure by automatically brushing daily.

■ **Hydrocarbon refrigerants (R-290)**

With innovative and eco-friendly technology, Turbo Air brings you hydrocarbon refrigerators designed to meet DOE's Energy Conservation Standards in 2017 and to use EPA's SNAP Program approved HC refrigerants. Hydrocarbon refrigerants do not deplete the ozone layer and have very low contribution to global warming (ODP-0, GWP-3).

■ **Attractive, elegant, glass sided Euro design**

Straight, tempered front & side glass with minimal frame provide full product visibility to optimize display effects. Its elegant contemporary euro design and luxurious colored case will not only enhance any store atmosphere but also will keep product presentation at its best and most beautiful.

■ **High-density polyurethane insulation**

The entire cabinet structure is foamed-in-place using high density, CFC free polyurethane insulation.

■ **Digital temperature controller**

■ **Double pane glass is tempered for safety (Front heated glass)**

■ **Adjustable, tempered glass shelf with AL front and back edges**

■ **Stainless steel floor and airflow grille**

■ **Sliding rear doors and front glass for product loading & unloading**



Self-Cleaning Condenser
Maintenance-free during warranty period

TBP36-46FDN

TBP48-46FDN

* Bottom portion will not be visible after installation

■ **Rear access to compressor compartment for quick and easy service**

■ **Standard features**

- Front glass door lock
- No plumbing required
- Safety shielded LED interior lighting
- 3" dia. swivel casters with locks on the rear set

- **Recommended operating conditions**

TBP models are designed to operate in an environment where temperature & humidity do not exceed 75°F and 55% respectively.

TBP-FDN MODELS SPECIFICATIONS

ELECTRICAL/DIMENSIONAL DATA	TBP36-46FDN	TBP48-46FDN	TBP60-46FDN
Voltage	115/60/1	115/60/1	115/60/1
Plug Type	Ⓢ NEMA 5-15P	Ⓢ NEMA 5-15P	Ⓢ NEMA 5-15P
Full Load Amp.	6.3	6.8	7.3
Compressor HP	1/3	3/4	3/4
Refrigerant	R-290	R-290	R-290
Net Capacity (cu. ft.)	9	12.4	15.7
Ext. Dimension (L x D x H*) (in.)	38 1/8 x 30 7/8 x 44 1/8	50 x 30 7/8 x 44 1/8	61 3/4 x 30 7/8 x 44 1/8
# of Shelves	1	1	1
Shelf Size (L x D) (in.)	31 3/8 x 13	43 1/4 x 13	55 x 13
Net / Gross Weight (lbs.)	327 / 504	398 / 597	465 / 686

ELECTRICAL/DIMENSIONAL DATA	TBP36-54FDN	TBP48-54FDN	TBP60-54FDN
Voltage	115/60/1	115/60/1	115/60/1
Plug Type	Ⓢ NEMA 5-15P	Ⓢ NEMA 5-15P	Ⓢ NEMA 5-15P
Full Load Amp.	7	8.2	8.7
Compressor HP	1/3	3/4	3/4
Refrigerant	R-290	R-290	R-290
Net Capacity (cu. ft.)	12.5	17.2	21.8
Ext. Dimension (L x D x H*) (in.)	38 1/8 x 30 7/8 x 52 1/8	50 x 30 7/8 x 52 1/8	61 3/4 x 30 7/8 x 52 1/8
# of Shelves	2	2	2
Shelf Size (L x D) (in.)	31 3/8 x 13, 31 3/8 x 11	43 1/4 x 13, 43 1/4 x 11	55 x 13, 55 x 11
Net / Gross Weight (lbs.)	362 / 550	433 / 643	505 / 741

Design and specifications subject to change without notice. Most updated spec sheets are available at www.turboairinc.com.

Actual shipping weight may differ due to extra packing materials for product protection.

* Height does not include 2-1/4" for caster height.

■ **WARRANTY: 2 Year Parts and Labor Warranty, 5 Year Compressor Warranty**



DISPLAY MERCHANDISERS

BEAUTY & BEAST®

Modern design to enhance impulsive sales
and LED lighting for high product visibility

Self-Cleaning Condenser

Eco-friendly hydrocarbon refrigerants

Simple plug-in installation,
no plumbing required

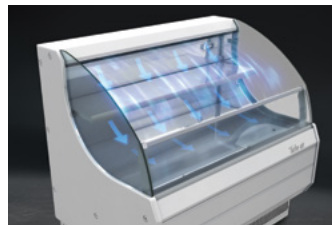



Underbar Equipment

- Bottle Coolers
- Glass / Mug Frosters
- Beer Dispensers
- Club Top Beer Dispensers
- Back Bars
- Narrow Back Bars

BOTTLE COOLERS NATURAL Refrigerant

Self-Cleaning Condenser Equipped Units

■ **Self-Cleaning Condenser (Patented)**

The accumulation of dust in the condenser can cause the failure or breakdown of refrigerators. Refrigerators run normally until they reach a certain level of accumulation. At some point, when they are over the limit, their performance drops quickly resulting in damage to, or disposal of the stored products inside. The Self-Cleaning Condenser device keeps the condenser clean and prevents system failure by automatically brushing daily.

■ **Hydrocarbon refrigerants (R-290 / R-600a)**

With innovative and eco-friendly technology, Turbo Air brings you hydrocarbon refrigerators designed to meet DOE's Energy Conservation Standards in 2017 and to use EPA's SNAP Program approved HC refrigerants. Hydrocarbon refrigerants do not deplete the ozone layer and have very low contribution to global warming (ODP-0, GWP-3).

■ **Forced air cooling system**

Fast cooling and balanced temperature throughout the cabinet.

■ **Stainless steel cabinet construction**

Super Deluxe (SD) models boast a stainless steel exterior (except galvanized steel back and bottom). SB models have an attractive wear-resistant black vinyl exterior. Heavy gauge stainless steel countertop and glide lids are perfect for sanitation and durability. The interior is stainless steel except galvanized steel top. Turbo Air Bottle Cooler model guarantees the utmost in cleanliness and long product life. It also adds a touch of style to the most refined setting.

■ **High-density polyurethane insulation**

The entire cabinet structure is foamed-in-place using high density, HCFC free polyurethane insulation.

■ **Adjustable, heavy duty, PE (polyethylene) coated dividers**

■ **Rugged built-in removable bottle cap opener and cap catcher**

■ **Large capacity cooler cabinet requires only minimum floor space**

■ **Side mount compressor unit**

With compressors positioned on the side of the unit, our refrigerators can now be serviced without being moved. Our front air intake feature also allows this model to be highly efficient in narrow spaces.



TBC-80SB-N



TBC-65SB-N6

Self-Cleaning Condenser
Maintenance-free during warranty period



TBC-24SD-N6

■ **Refrigerator holds 33°F ~ 38°F for optimal beverage preservation**

■ **Standard features**

- Door locks
- Anti-corrosion coated evaporator
- Self-contained system
- 2.5" dia. swivel casters

■ **Optional features**

- 2" dia. casters available
- 6" height adjustable legs available

TBC MODELS SPECIFICATIONS

ELECTRICAL DATA	TBC-24SB-N6	TBC-36SB-N6	TBC-50SB-N6	TBC-65SB-N6	TBC-80SB-N	TBC-95SB-N
	TBC-24SD-N6	TBC-36SD-N6	TBC-50SD-N6	TBC-65SD-N6	TBC-80SD-N	TBC-95SD-N
Voltage	115/60/1	115/60/1	115/60/1	115/60/1	115/60/1	115/60/1
Plug Type	Ⓢ NEMA 5-15P	Ⓢ NEMA 5-15P	Ⓢ NEMA 5-15P	Ⓢ NEMA 5-15P	Ⓢ NEMA 5-15P	Ⓢ NEMA 5-15P
Full Load Amp.	1.4	1.6	1.7	1.7	2.5	2.5
Compressor HP	1/8	1/8	1/5	1/5	1/3	1/3
Refrigerant	R-600a	R-600a	R-600a	R-600a	R-290	R-290
Cord Length (ft.)	8.5	8.5	8.5	8.5	8.5	8.5
DIMENSIONAL DATA						
Capacity (12oz.btls. - 6pack)	5	12	18	22	30.8	38
Net Capacity (cu. ft.)	3.6	8.5	13.5	18.5	22.6	30.3
Ext. Dimension (L x D [*] x H [†]) (in.)	24 7/8 x 26 1/2 x 33 1/4	36 3/4 x 26 1/2 x 33 1/4	50 x 26 1/2 x 33 1/4	64 3/8 x 26 1/2 x 33 1/4	80 1/2 x 26 1/2 x 33 1/4	95 x 26 1/2 x 33 1/4
# of Dividers	2	2	3	4	5	6
# of Bottom Shelves	1	1	2	3	4	5
# of Casters	4	5	5	5	7	7
Net Weight (lbs.)	155	190	234	309	345	375
Gross Weight (lbs.)	175	221	256	326	378	397

Design and specifications subject to change without notice. Most updated spec sheets are available at www.turboairinc.com.

Actual shipping weight may differ due to extra packing materials for product protection.

* Depth does not include 1-7/8" for cap catcher or 1-1/4" for rear spacers. † Height does not include 3-1/8" for caster height.

■ **WARRANTY: 5 Year Parts and Labor Warranty, 7 Year Compressor Warranty**

GLASS / MUG FROSTERS NATURAL Refrigerant

Self-Cleaning Condenser Equipped Units

■ Self-Cleaning Condenser (Patented)

The accumulation of dust in the condenser can cause the failure or breakdown of refrigerators. Refrigerators run normally until they reach a certain level of accumulation. At some point, when they are over the limit, their performance drops quickly resulting in damage to, or disposal of the stored products inside. The Self-Cleaning Condenser device keeps the condenser clean and prevents system failure by automatically brushing daily.

■ Hydrocarbon refrigerants (R-290 / R-600a)

With innovative and eco-friendly technology, Turbo Air brings you hydrocarbon refrigerators designed to meet DOE's Energy Conservation Standards in 2017 and to use EPA's SNAP Program approved HC refrigerants. Hydrocarbon refrigerants do not deplete the ozone layer and have very low contribution to global warming (ODP-0, GWP-3).

■ Stainless steel cabinet construction

Super Deluxe (SD) models boast a stainless steel exterior (except galvanized steel back and bottom). SB models have an attractive wear-resistant black vinyl exterior. Heavy gauge stainless steel countertop and glide lids are perfect for sanitation and durability. The interior is stainless steel except galvanized steel top. Turbo Air Glass Froster model guarantees the utmost in cleanliness and long product life. It also adds a touch of style to the most refined setting.

■ High-density polyurethane insulation

The entire cabinet structure is foamed-in-place using high density, HCFC free polyurethane insulation.

■ Heavy duty, PE (polyethylene) coated dividers

Heavy duty 10mm thick pure grade PE coated shelves are provided for maximum storage use.

■ Manual defrost system

■ Direct cooling type

■ Large capacity cooler cabinet requires only minimum floor space

■ Side mount compressor unit

With compressors positioned on the side of the unit, our refrigerators can now be serviced without being moved. Our front air intake feature also allows this model to be highly efficient in narrow spaces.



Self-Cleaning Condenser
Maintenance-free
during warranty period

TBC-50SB-GF-N



TBC-24SD-GF-N6

■ Glass/mug froster holds 5°F ~ 20°F for optimal glass and plate chilling

■ Standard features

- Door locks
- Anti-corrosion coated evaporator
- Self-contained system
- 2.5" dia. swivel casters

■ Optional features

- 2" dia. casters available
- 6" height adjustable legs available

TBC-GF MODELS SPECIFICATIONS

ELECTRICAL DATA	TBC-24SB-GF-N6	TBC-36SB-GF-N	TBC-50SB-GF-N
	TBC-24SD-GF-N6	TBC-36SD-GF-N	TBC-50SD-GF-N
Voltage	115/60/1	115/60/1	115/60/1
Plug Type	Ⓜ NEMA 5-15P	Ⓜ NEMA 5-15P	Ⓜ NEMA 5-15P
Full Load Amp.	0.9	1.6	1.7
Compressor HP	1/8	1/3	1/3
Refrigerant	R-600a	R-290	R-290
Cord Length (ft.)	8.5	8.5	8.5
DIMENSIONAL DATA			
Capacity (8" (36oz) Mug / 10oz Stein)	48 / 129	93 / 227	140 / 386
Net Capacity (cu. ft.)	4.56	9.74	14.49
Ext. Dimension (L x D x H†) (in.)	24 7/8 x 26 1/2 x 33 1/4	36 3/4 x 26 1/2 x 33 1/4	50 x 26 1/2 x 33 1/4
# of Shelves (# of Bottom Shelves)	2 (2)	5 (2)	5 (2)
# of Casters	4	5	5
Net Weight (lbs.)	154	190	234
Gross Weight (lbs.)	165	201	256

Design and specifications subject to change without notice. Most updated spec sheets are available at www.turboairinc.com.

Actual shipping weight may differ due to extra packing materials for product protection.

* Depth does not include 1-1/4" for rear spacers. † Height does not include 3-1/8" for caster height.

■ WARRANTY: 5 Year Parts and Labor Warranty, 7 Year Compressor Warranty

BEER DISPENSERS NATURAL Refrigerant

Self-Cleaning Condenser Equipped Units

■ **Self-Cleaning Condenser (Patented)**

The accumulation of dust in the condenser can cause the failure or breakdown of refrigerators. Refrigerators run normally until they reach a certain level of accumulation. At some point, when they are over the limit, their performance drops quickly resulting in damage to, or disposal of the stored products inside. The Self-Cleaning Condenser device keeps the condenser clean and prevents system failure by automatically brushing daily (except TBD-1SDD/1SBD-N6).

■ **Hydrocarbon refrigerants (R-290 / R-600a)**

With innovative and eco-friendly technology, Turbo Air brings you hydrocarbon refrigerators designed to meet DOE's Energy Conservation Standards in 2017 and to use EPA's SNAP Program approved HC refrigerants. Hydrocarbon refrigerants do not deplete the ozone layer and have very low contribution to global warming (ODP-0, GWP-3).

■ **Digital Temperature Controller**

External digital temperature control has an easily accessible panel to quickly adjust temperatures, which includes a defrost control (except TBD-1SBD/SDD-N6).

■ **Forced air cooling system**

Fast cooling and balanced temperature throughout the cabinet.

■ **Stainless steel cabinet construction**

Super Deluxe (SD) models boast a stainless steel exterior (except galvanized steel back and bottom). SB models have an attractive wear-resistant black vinyl exterior. Heavy gauge stainless steel countertop is perfect for sanitation and durability. The interior is stainless steel except galvanized steel top. Spacious inside construction with 32" (31 1/4" for TBD-1SDD/SBD-N6) inner height accommodates various sizes of beer kegs. Turbo Air beer dispenser model guarantees the utmost in cleanliness and long product life. It also adds a touch of style to the most refined setting.

■ **High-density polyurethane insulation**

The entire cabinet structure is foamed-in-place using high density, HCFC free polyurethane insulation.

■ **3" diameter stainless steel insulated beer towers**

■ **Ergonomically designed doors**

Customers' fatigue fades away with easy grip handles and doors that open effortlessly. These features along with self-closing doors make this the ultimate choice in customer convenience.

■ **Side mount compressor unit**

With compressors positioned on the side of the unit, our refrigerators can now be serviced without being moved. Our front air intake feature also allows this model to be highly efficient in narrow spaces.



TBD-4SBD-N

- Does not include keg couplers

Self-Cleaning Condenser Maintenance-free during warranty period TBD-3SDD-N6

■ **Comes standard with a two-way (TBD-1SBD/SDD-N6) & a four-way (TBD-2SBD/SDD-N6, TBB-3SBD/SDD-N6, TBB-4SBD/SDD-N) tapper manifold**

■ **Beer dispenser holds 33°F ~ 38°F for optimal beverage preservation**

■ **Standard features**

- Anti-corrosion coated evaporator
- Double faucet beer tower
- Door locks
- Self-contained system
- 2.5" dia. swivel casters (4" casters only for TBD-1SBD/SDD-N6)

■ **Optional features**

- 2" dia. casters available (except TBD-1SBD/SDD-N6)
- 6" height adjustable legs available
- Triple faucet beer tower available

TBD MODELS SPECIFICATIONS

ELECTRICAL DATA	TBD-1SBD-N6 TBD-1SDD-N6	TBD-2SBD-N6 TBD-2SDD-N6	TBD-3SBD-N6 TBD-3SDD-N6	TBD-4SBD-N TBD-4SDD-N
Voltage	115/60/1	115/60/1	115/60/1	115/60/1
Plug Type	Ⓜ NEMA 5-15P	Ⓜ NEMA 5-15P	Ⓜ NEMA 5-15P	Ⓜ NEMA 5-15P
Full Load Amp.	1.1	1.9	2.5	2.7
Compressor HP	1/8	1/5	1/5	1/3
Refrigerant	R-600a	R-600a	R-600a	R-290
Cord Length (ft.)	8.5	8.5	8.5	8.5
DIMENSIONAL DATA				
Capacity (1/2 Barrels)	1	2	3	4
Net Capacity	10.81	17.12	21.19	29.64
Ext. Dimension (L x D x H) (in.)	23 ^{5/8} x 29 ^{3/4} x 34 ^{1/2} †	58 ^{3/4} x 27 ^{1/4} ‡ x 37 ^{1/8} ‡	69 x 27 ^{1/4} ‡ x 37 ^{1/8} ‡	90 ^{1/4} x 27 ^{1/4} ‡ x 37 ^{1/8} ‡
# of Swing Door	1	2	2	3
# of Casters	4	6	6	6
Net Weight (lbs.)	175	286	298	420
Gross Weight (lbs.)	185	298	320	443

Design and specifications subject to change without notice. Most updated spec sheets are available at www.turboairinc.com.

Actual shipping weight may differ due to extra packing materials for product protection.

* Depth does not include 3/8" for door handles and 2-3/8" for rear spacers. ‡Depth does not include 3/8" for door handles and 1-1/4" for rear spacers.

† Height does not include 4-7/8" for caster height and 16" for draft arm. ‡ Height does not include 3-1/8" for caster height and 16" for draft arm.

■ **WARRANTY: 5 Year Parts and Labor Warranty, 7 Year Compressor Warranty**

CLUB TOP BEER DISPENSERS NATURAL Refrigerant

Self-Cleaning Condenser Equipped Units

■ **Self-Cleaning Condenser (Patented)**

The accumulation of dust in the condenser can cause the failure or breakdown of refrigerators. Refrigerators run normally until they reach a certain level of accumulation. At some point, when they are over the limit, their performance drops quickly resulting in damage to, or disposal of the stored products inside. The Self-Cleaning Condenser device keeps the condenser clean and prevents system failure by automatically brushing daily.

■ **Hydrocarbon refrigerants (R-290 / R-600a)**

With innovative and eco-friendly technology, Turbo Air brings you hydrocarbon refrigerators designed to meet DOE's Energy Conservation Standards in 2017 and to use EPA's SNAP Program approved HC refrigerants. Hydrocarbon refrigerants do not deplete the ozone layer and have very low contribution to global warming (ODP-0, GWP-3).

■ **Digital Temperature Controller**

External digital temperature control has an easily accessible panel to quickly adjust temperatures, which includes a defrost control.

■ **Forced air cooling system**

Fast cooling and balanced temperature throughout the cabinet.

■ **Stainless steel cabinet construction**

Super Deluxe (SD) models boast a stainless steel exterior (except galvanized steel back and bottom). SB models have an attractive wear-resistant black vinyl exterior. Heavy gauge stainless steel countertop and club top lids are perfect for sanitation and durability. The interior is stainless steel except galvanized steel top. Spacious inside construction with 32" inner height accommodates various sizes of beer kegs. Turbo Air Club Top model guarantees the utmost in cleanliness and long product life. It also adds a touch of style to the most refined setting.

■ **High-density polyurethane insulation**

The entire cabinet structure is foamed-in-place using high density, HCFC free polyurethane insulation.

■ **Club top (TCB) models provide easy access to the interior area**

Club Top is a combined functional cabinet of direct draw cold beer dispenser and refrigerator. This convenient model provides easy access to interior storage area of the refrigerator for chilled beer bottles or cans.

■ **Ergonomically designed doors**

Customers' fatigue fades away with easy grip handles and doors that open effortlessly. These features along with self-closing doors make this the ultimate choice in customer convenience.



Self-Cleaning Condenser
Maintenance-free
during warranty period

TCB-4SDD-N

TCB-2SBD-N6

■ **3" diameter stainless steel insulated beer towers**

■ **Comes standard with a four-way tapper manifold**

■ **Easy to glide stainless steel club top lids**

■ **Side mount compressor unit**

With compressors positioned on the side of the unit, our refrigerators can now be serviced without being moved. Our front air intake feature also allows this model to be highly efficient in narrow spaces.

■ **Club top beer dispenser holds 33°F ~ 38°F for optimal beverage preservation**

■ **Standard features**

- Anti-corrosion coated evaporator
- Double faucet beer tower
- Door locks
- Self-contained system
- 2.5" dia. swivel casters

■ **Optional features**

- 2" dia. casters available
- 6" height adjustable legs available
- Triple faucet beer tower available

TCB MODELS SPECIFICATIONS

ELECTRICAL DATA	TCB-2SBD-N6 TCB-2SDD-N6	TCB-3SBD-N6 TCB-3SDD-N6	TCB-4SBD-N TCB-4SDD-N
Voltage	115/60/1	115/60/1	115/60/1
Plug Type	Ⓜ NEMA 5-15P	Ⓜ NEMA 5-15P	Ⓜ NEMA 5-15P
Full Load Amp.	1.3	2.3	2.6
Compressor HP	1/5	1/5	1/3
Refrigerant	R-600a	R-600a	R-290
Cord Length (ft.)	8.5	8.5	8.5
DIMENSIONAL DATA			
Capacity (1/2 Barrels)	2	3	4
Net Capacity	20.9	25.4	36.47
Ext. Dimension (L x D* x H†) (in.)	58 ^{7/8} x 27 ^{1/4} x 38 ^{5/8}	69 ^{1/8} x 27 ^{1/4} x 38 ^{5/8}	90 ^{3/8} x 27 ^{1/4} x 38 ^{5/8}
# of Swing Door	2	2	3
# of Casters	6	6	6
Net Weight (lbs.)	335	355	425
Gross Weight (lbs.)	357	378	448

Design and specifications subject to change without notice. Most updated spec sheets are available at www.turboairinc.com.

Actual shipping weight may differ due to extra packing materials for product protection.

* Depth does not include 3/8" for door handles & 1-1/4" for rear spacers. † Height does not include 3-1/8" for caster height. Height does not include 14-1/2" for draft arm.

■ **WARRANTY: 5 Year Parts and Labor Warranty, 7 Year Compressor Warranty**

BACK BARS NATURAL Refrigerant

Self-Cleaning Condenser Equipped Units

Self-Cleaning Condenser (Patented)

The accumulation of dust in the condenser can cause the failure or breakdown of refrigerators. Refrigerators run normally until they reach a certain level of accumulation. At some point, when they are over the limit, their performance drops quickly resulting in damage to, or disposal of the stored products inside. The Self-Cleaning Condenser device keeps the condenser clean and prevents system failure by automatically brushing daily (except TBB-1SBD-N6).

Hydrocarbon refrigerants (R-290 / R-600a)

With innovative and eco-friendly technology, Turbo Air brings you hydrocarbon refrigerators designed to meet DOE's Energy Conservation Standards in 2017 and to use EPA's SNAP Program approved HC refrigerants. Hydrocarbon refrigerants do not deplete the ozone layer and have very low contribution to global warming (ODP-0, GWP-3).

Digital Temperature Controller

External digital temperature control has an easily accessible panel to quickly adjust temperatures, which includes a defrost control (except TBB-1SBD-N6).

A color-selectable LED interior lighting

This LED light with 7 color options will make your bar a more atmospheric space (only SGD models).

Forced air cooling system

Fast cooling and balanced temperature throughout the cabinet.

Stainless steel countertop and interior

The exterior of the cabinet is constructed with heavy gauge reinforced stainless steel countertop and wear-resistant black vinyl coated galvanized steel. The interior is painted galvanized steel with reinforced stainless steel floor. Turbo Air Back Bar model guarantees the utmost in cleanliness and long product life. It also adds a touch of style to the most refined setting.

Ergonomically designed doors

Customers' fatigue fades away with easy grip handles and doors that open effortlessly. These features along with self-closing doors make this the ultimate choice in customer convenience.

Double pane glass doors with Low-E glass (SGD Models)



TBB-2SBD-N6

TBB-3SGD-N

High-density polyurethane insulation

The entire cabinet structure is foamed-in-place using high density, HCFC free polyurethane insulation.

Side mount compressor unit

With compressors positioned on the side of the unit, our refrigerators can now be serviced without being moved. Our front air intake feature also allows this model to be highly efficient in narrow spaces.

Refrigerator holds 33°F ~ 38°F for optimal beverage preservation

Standard features

- Anti-corrosion coated evaporator
- Self-contained system
- 2.5" dia. swivel casters (4" casters only for TBB-1SBD-N6)
- Door locks

Optional features

- 2" dia. casters available (except TBB-1SBD-N6)
- 6" height adjustable legs available

TBB MODELS SPECIFICATIONS

ELECTRICAL DATA	TBB-1SBD-N6	TBB-2SBD-N6 TBB-2SGD-N	TBB-3SBD-N6 TBB-3SGD-N	TBB-4SBD-N TBB-4SGD-N
Voltage	115/60/1	115/60/1	115/60/1	115/60/1
Plug Type	Ⓜ NEMA 5-15P	Ⓜ NEMA 5-15P	Ⓜ NEMA 5-15P	Ⓜ NEMA 5-15P
Full Load Amp.	1.3	1.7(SBD) / 2.8(SGD)	1.9(SBD) / 2.8(SGD)	2.9(SBD) / 3.6(SGD)
Compressor HP	1/8	1/5(SBD) / 1/3(SGD)	1/5(SBD) / 1/3(SGD)	1/3
Refrigerant	R-600a	R-600a(SBD) / R-290(SGD)	R-600a(SBD) / R-290(SGD)	R-290
Cord Length (ft.)	8.5	8.5	8.5	8.5
Lamp (W)	6.5	12.5	16.5	12.5 x 2ea
DIMENSIONAL DATA				
Capacity (12oz.btls./12oz.cans-6pack)	24 / 33	70 / 85	85 / 105	110 / 140
Capacity (cu.ft.)	7.76	19	23	36.47
Ext. Dimension (L x D x H) (in.)	23 ^{5/8} x 29 ^{3/4} x 34 ^{1/2} †	58 ^{3/4} x 27 ^{1/4} * x 37 ^{1/8} ‡	69 x 27 ^{1/4} * x 37 ^{1/8} ‡	90 ^{1/4} x 27 ^{1/4} * x 37 ^{1/8} ‡
# of Swing Door	1	2	2	3
# of Shelves (Sub Shelves)	2 (0)	4 (2)	4 (2)	6 (2)
Shelf Size (L x D) (in.)	18 ^{1/2} x 19 ^{1/2}	24 ^{3/8} x 19 ^{3/8} (L), 20 x 19 ^{3/8} (R)	29 ^{1/4} x 19 ^{3/8} (L), 25 x 19 ^{3/8} (R)	26 ^{1/2} x 19 ^{3/8} (L), 25 ^{3/4} x 19 ^{3/8} (M), 22 ^{1/4} x 19 ^{3/8} (R)
# of Casters	4	6	6	6
Net Weight (lbs.)	190	276(SBD) / 309(SGD)	298(SBD) / 353(SGD)	457(SBD) / 523(SGD)
Gross Weight (lbs.)	212	298(SBD) / 331(SGD)	320(SBD) / 375(SGD)	479(SBD) / 545(SGD)

Design and specifications subject to change without notice. Most updated spec sheets are available at www.turboairinc.com.

Actual shipping weight may differ due to extra packing materials for product protection.

* Depth does not include 3/8" for door handles and 2-3/8" for rear spacers. †Depth does not include 1-1/2"(SGD) / 3/8"(SBD) for door handles and 1-1/4" for rear spacers.

‡ Height does not include 4-7/8" for caster height. † Height does not include 3-1/8" for caster height.

WARRANTY: 5 Year Parts and Labor Warranty, 7 Year Compressor Warranty

BACK BARS **NATURAL Refrigerant**

Self-Cleaning Condenser Equipped Units

- **Self-Cleaning Condenser (Patented)**
 The accumulation of dust in the condenser can cause the failure or breakdown of refrigerators. Refrigerators run normally until they reach a certain level of accumulation. At some point, when they are over the limit, their performance drops quickly resulting in damage to, or disposal of the stored products inside. The Self-Cleaning Condenser device keeps the condenser clean and prevents system failure by automatically brushing daily.
- **Hydrocarbon refrigerants (R-290 / R-600a)**
 With innovative and eco-friendly technology, Turbo Air brings you hydrocarbon refrigerators designed to meet DOE's Energy Conservation Standards in 2017 and to use EPA's SNAP Program approved HC refrigerants. Hydrocarbon refrigerants do not deplete the ozone layer and have very low contribution to global warming (ODP-0, GWP-3).
- **Digital Temperature Controller**
 External digital temperature control has an easily accessible panel to quickly adjust temperatures, which includes a defrost control.
- **A color-selectable LED interior lighting**
 This LED light with 7 color options will make your bar a more atmospheric space (only SGSD models).
- **Forced air cooling system**
 Fast cooling and balanced temperature throughout the cabinet.
- **Stainless steel cabinet construction**
 The exterior and interior of the cabinet are constructed with heavy gauge reinforced stainless steel. Turbo Air Back Bar model guarantees the utmost in cleanliness and long product life. It also adds a touch of style to the most refined setting.
- **Ergonomically designed doors**
 Customers' fatigue fades away with easy grip handles and doors that open effortlessly. These features along with self-closing doors make this the ultimate choice in customer convenience.
- **Double pane glass doors with Low-E glass (SGSD Models)**
- **High-density polyurethane insulation**
 The entire cabinet structure is foamed-in-place using high density, HCFC free polyurethane insulation.



- **Side mount compressor unit**
 With compressors positioned on the side of the unit, our refrigerators can now be serviced without being moved. Our front air intake feature also allows this model to be highly efficient in narrow spaces.
- **Refrigerator holds 33°F ~ 38°F for optimal beverage preservation**
- **Standard features**

 - Anti-corrosion coated evaporator
 - Self-contained system
 - 2.5" dia. swivel casters
 - Door locks
- **Optional features**

 - 2" dia. casters available
 - 6" height adjustable legs available

TBB MODELS SPECIFICATIONS

ELECTRICAL DATA	TBB-2SSD-N6	TBB-2SGSD-N
Voltage	115/60/1	115/60/1
Plug Type	Ⓜ NEMA 5-15P	Ⓜ NEMA 5-15P
Full Load Amp.	1.7	2.8
Compressor HP	1/5	1/3
Refrigerant	R-600a	R-290
Cord Length (ft.)	8.5	8.5
Lamp (W)	12.5	12.5
DIMENSIONAL DATA		
Capacity (12oz.btls./12oz.cans-6pack)	70 / 85	70 / 85
Capacity (cu.ft.)	19	19
Ext. Dimension (L x D x H) (in.)	58 ³ / ₄ x 27 ¹ / ₄ * x 37 ¹ / ₈ †	58 ³ / ₄ x 27 ¹ / ₄ * x 37 ¹ / ₈ †
# of Swing Door	2	2
# of Shelves (Sub Shelves)	4 (2)	4 (2)
Shelf Size (L x D) (in.)	24 ³ / ₈ x 19 ³ / ₈ (L), 20 x 19 ³ / ₈ (R)	24 ³ / ₈ x 19 ³ / ₈ (L), 20 x 19 ³ / ₈ (R)
# of Casters	6	6
Net Weight (lbs.)	276	309
Gross Weight (lbs.)	298	331

Design and specifications subject to change without notice. Most updated spec sheets are available at www.turboairinc.com.

Actual shipping weight may differ due to extra packing materials for product protection.

* Depth does not include 3/8"(SSD) / 1-1/2"(SGSD) for door handles and 1-1/4" for rear spacers.

† Height does not include 3-1/8" for caster height.

■ **WARRANTY: 5 Year Parts and Labor Warranty, 7 Year Compressor Warranty**

NARROW BACK BARS NATURAL Refrigerant

■ **Equipped with easy-to-clean Air Filter**

The accumulation of dust in the condenser causes failures or breakdowns in refrigeration. Refrigeration operate normally until they accumulate a certain amount of dust. When they reach their limit, performance will drop rapidly, resulting in damages and possible disposal of stored goods. This is why all refrigeration manufacturers require the condenser to be cleaned at least once a month for warranty to remain valid. With Turbo Air, this process is simple and easy due to the frontal access air filter device. Pull out the filter and vacuum lightly to remove the dust. Place it back into position when complete.

■ **Hydrocarbon refrigerants (R-290 / R-600a)**

With innovative and eco-friendly technology, Turbo Air brings you hydrocarbon refrigerators designed to meet DOE's Energy Conservation Standards in 2017 and to use EPA's SNAP Program approved HC refrigerants. Hydrocarbon refrigerants do not deplete the ozone layer and have very low contribution to global warming (ODP-0, GWP-3).

■ **Digital Temperature Controller**

External digital temperature control has an easily accessible panel to quickly adjust temperatures, which includes a defrost control.

■ **A color-selectable LED interior lighting**

This LED light with 7 color options will make your bar a more atmospheric space (only SGD models).

■ **Forced air cooling system**

Fast cooling and balanced temperature throughout the cabinet.

■ **Stainless steel countertop and interior**

The exterior of the cabinet is constructed with heavy gauge reinforced stainless steel countertop and wear-resistant black vinyl coated galvanized steel. The interior is stainless steel except galvanized steel top. Turbo Air Back Bar model guarantees the utmost in cleanliness and long product life. It also adds a touch of style to the most refined setting.

■ **Ergonomically designed doors**

Customers' fatigue fades away with easy grip handles and doors that open effortlessly. These features along with self-closing doors make this the ultimate choice in customer convenience.

■ **Double pane glass doors with Low-E glass (SGD Models)**



TBB-24-72SGD-N

TBB-24-48SBD-N6

■ **High-density polyurethane insulation**

The entire cabinet structure is foamed-in-place using high density, HCFC free polyurethane insulation.

■ **Side mount compressor unit**

With compressors positioned on the side of the unit, our refrigerators can now be serviced without being moved. Our front air intake feature also allows this model to be highly efficient in narrow spaces.

■ **Refrigerator holds 33°F ~ 38°F for optimal beverage preservation**

■ **Standard features**

- Anti-corrosion coated evaporator
- Self-contained system
- 2.5" dia. swivel casters
- Door locks

■ **Optional features**

- 2" dia. casters available
- 6" height adjustable legs available

TBB MODELS SPECIFICATIONS

ELECTRICAL DATA	TBB-24-48SBD-N6 TBB-24-48SGD-N	TBB-24-60SBD-N6 TBB-24-60SGD-N	TBB-24-72SBD-N6 TBB-24-72SGD-N
Voltage	115/60/1	115/60/1	115/60/1
Plug Type	Ⓢ NEMA 5-15P	Ⓢ NEMA 5-15P	Ⓢ NEMA 5-15P
Full Load Amp.	1.8(SBD) / 2.6(SGD)	2.0(SBD) / 2.9(SGD)	2.0(SBD) / 2.9(SGD)
Compressor HP	1/5(SBD) / 1/3(SGD)	1/5(SBD) / 1/3(SGD)	1/5(SBD) / 1/3(SGD)
Refrigerant	R-600a(SBD) / R-290(SGD)	R-600a(SBD) / R-290(SGD)	R-600a(SBD) / R-290(SGD)
Cord Length (ft.)	8.5	8.5	8.5
Lamp (W)	7.5	9	9
DIMENSIONAL DATA			
Capacity (12oz. btls./12oz. cans-6pack)	45 / 60	70 / 85	90 / 105
Capacity (cu.ft.)	12.2	16.46	20.62
Ext. Dimension (L x D x H†) (in.)	49 1/8 x 24 1/2 x 35 3/8	61 1/8 x 24 1/2 x 35 3/8	73 1/8 x 24 1/2 x 35 3/8
# of Swing Door	2	2	3
# of Shelves (Size (L x D) (in.))	4 (16 3/4 x 18)	4 (22 7/8 x 18)	6 (20 1/4 x 18 (L), 18 1/2 x 18 (M/R))
# of Casters	5	6	6
Net Weight (lbs.)	214	278	357
Gross Weight (lbs.)	238	309	397

Design and specifications subject to change without notice. Most updated spec sheets are available at www.turboairinc.com.

Actual shipping weight may differ due to extra packing materials for product protection.

* Depth does not include 1-1/2"(SGD) / 3/8"(SBD) for door handles. Depth does not include 1-1/4" for rear spacers. † Height does not include 3-1/8" for caster height.

■ **WARRANTY: 5 Year Parts and Labor Warranty, 7 Year Compressor Warranty**

NARROW BACK BARS NATURAL Refrigerant

■ **Equipped with easy-to-clean Air Filter**

The accumulation of dust in the condenser causes failures or breakdowns in refrigeration. Refrigeration operate normally until they accumulate a certain amount of dust. When they reach their limit, performance will drop rapidly, resulting in damages and possible disposal of stored goods. This is why all refrigeration manufacturers require the condenser to be cleaned at least once a month for warranty to remain valid. With Turbo Air, this process is simple and easy due to the frontal access air filter device. Pull out the filter and vacuum lightly to remove the dust. Place it back into position when complete.

■ **Hydrocarbon refrigerants (R-290 / R-600a)**

With innovative and eco-friendly technology, Turbo Air brings you hydrocarbon refrigerators designed to meet DOE's Energy Conservation Standards in 2017 and to use EPA's SNAP Program approved HC refrigerants. Hydrocarbon refrigerants do not deplete the ozone layer and have very low contribution to global warming (ODP-0, GWP-3).

■ **Digital Temperature Controller**

External digital temperature control has an easily accessible panel to quickly adjust temperatures, which includes a defrost control.

■ **A color-selectable LED interior lighting**

This LED light with 7 color options will make your bar a more atmospheric space (only SGSD models).

■ **Forced air cooling system**

Fast cooling and balanced temperature throughout the cabinet.

■ **Stainless steel cabinet construction**

The exterior and interior of the cabinet are constructed with heavy gauge reinforced stainless steel. Turbo Air Back Bar model guarantees the utmost in cleanliness and long product life. It also adds a touch of style to the most refined setting.

■ **Ergonomically designed doors**

Customers' fatigue fades away with easy grip handles and doors that open effortlessly. These features along with self-closing doors make this the ultimate choice in customer convenience.

■ **Double pane glass doors with Low-E glass (SGSD Models)**

■ **High-density polyurethane insulation**

The entire cabinet structure is foamed-in-place using high density, HCFC free polyurethane insulation.



TBB-24-72SGSD-N

TBB-24-72SSD-N6

■ **Side mount compressor unit**

With compressors positioned on the side of the unit, our refrigerators can now be serviced without being moved. Our front air intake feature also allows this model to be highly efficient in narrow spaces.

■ **Refrigerator holds 33°F ~ 38°F for optimal beverage preservation**

■ **Standard features**

- Anti-corrosion coated evaporator
- Self-contained system
- 2.5" dia. swivel casters
- Door locks

■ **Optional features**

- 2" dia. casters available
- 6" height adjustable legs available

TBB MODELS SPECIFICATIONS

ELECTRICAL DATA	TBB-24-48SSD-N6	TBB-24-60SSD-N6	TBB-24-72SSD-N6
	TBB-24-48SGSD-N	TBB-24-60SGSD-N	TBB-24-72SGSD-N
Voltage	115/60/1	115/60/1	115/60/1
Plug Type	Ⓢ NEMA 5-15P	Ⓢ NEMA 5-15P	Ⓢ NEMA 5-15P
Full Load Amp.	1.8(SSD) / 2.6(SGSD)	2.0(SSD) / 2.9(SGSD)	2.0(SSD) / 2.9(SGSD)
Compressor HP	1/5(SSD) / 1/3(SGSD)	1/5(SSD) / 1/3(SGSD)	1/5(SSD) / 1/3(SGSD)
Refrigerant	R-600a(SSD) / R-290(SGSD)	R-600a(SSD) / R-290(SGSD)	R-600a(SSD) / R-290(SGSD)
Cord Length (ft.)	8.5	8.5	8.5
Lamp (W)	7.5	9	9
DIMENSIONAL DATA			
Capacity (12oz.btls./12oz.cans-6pack)	45 / 60	70 / 85	90 / 105
Capacity (cu.ft.)	12.2	16.46	20.62
Ext. Dimension (L x D [†] x H [†]) (in.)	49 ¹ / ₈ x 24 ¹ / ₂ x 35 ³ / ₈	61 ¹ / ₈ x 24 ¹ / ₂ x 35 ³ / ₈	73 ¹ / ₈ x 24 ¹ / ₂ x 35 ³ / ₈
# of Swing Door	2	2	3
# of Shelves (Size (L x D) (in.))	4 (16 ³ / ₄ x 18)	4 (22 ⁷ / ₈ x 18)	6 (20 ¹ / ₄ x 18 (L), 18 ¹ / ₂ x 18 (M/R))
# of Casters	5	6	6
Net Weight (lbs.)	214	278	357
Gross Weight (lbs.)	238	309	397

Design and specifications subject to change without notice. Most updated spec sheets are available at www.turboairinc.com.

Actual shipping weight may differ due to extra packing materials for product protection.

* Depth does not include 1-1/2"(SGSD) / 3/8"(SSD) for door handles. Depth does not include 1-1/4" for rear spacers. † Height does not include 3-1/8" for caster height.

■ **WARRANTY: 5 Year Parts and Labor Warranty, 7 Year Compressor Warranty**



Digital Type Underbar Equipment

- Self-Cleaning Condenser
- A color-selectable LED interior lighting (only Back Bar SGD models)
- Digital Temperature Controller (except 1 door models)
- Forced air cooling system
- Hydrocarbon refrigerants (R-290/R-600a)
- Stainless steel cabinet construction
- CFC free Polyurethane insulation
- Heavy duty, PE coated dividers
- Double pane glass doors with Low-E glass (only Back Bar SGD models)
- 5 years parts and labor warranty, 7 Year Compressor Warranty





Milk Coolers

Super Deluxe Series
Milk Coolers

MILK COOLERS - DUAL SIDED DOOR NATURAL Refrigerant

■ **Hydrocarbon refrigerants (R-600a)**

With innovative and eco-friendly technology, Turbo Air brings you hydrocarbon refrigerators designed to meet DOE's Energy Conservation Standards in 2017 and to use EPA's SNAP Program approved HC refrigerants. Hydrocarbon refrigerants do not deplete the ozone layer and have very low contribution to global warming (ODP-0, GWP-3).

■ **Extended cleaning-free condenser**

Electrodeposition coating is applied to prevent condenser corrosion, and wire condenser are applied to prevent dust from accumulating.

■ **Exterior digital thermometer standard for easy visibility**

Exterior digital temperature display allows easy reading and precise and constant temperature. This level of precision allows milk to remain fresh and safe over an extended period of time.

■ **Sturdy and clean, durable stainless steel cabinet construction**

Exterior is stainless steel with stainless steel door. Interior is comprised of stainless steel.

■ **High-density polyurethane insulation**

The entire cabinet construction is foamed-in-place using high density, environmental friendly CFC free polyurethane insulation.

■ **Convenient bottom floor drain standard with hose adapter**

Floor drain is located in the rear on the right hand side for easy clean out. The hose adapter allows for convenient connecting to drain hose.

■ **Stainless steel self-service doors have drop front feature and hold-open flip-up top lid**

■ **4" dia. swivel casters standard for easy movement, two with brakes to lock the unit in place**

■ **Direct cooling type**

■ **Refrigerator holds 33°F ~ 38°F for the best in milk preservation**

■ **Standard features**

- Door locks
- Heavy duty floor racks
- Door support bumpers



TMKC-58-2-WS-N6

* Milk crates not included

TMKC-58-2-SS-N6



TMKC-34-2-WS-N6

TMKC MODELS SPECIFICATIONS

ELECTRICAL DATA	TMKC-34-2-SS(WS)-N6	TMKC-49-2-SS(WS)-N6	TMKC-58-2-SS(WS)-N6
Voltage	115/60/1	115/60/1	115/60/1
Plug Type	Ⓢ NEMA 5-15P	Ⓢ NEMA 5-15P	Ⓢ NEMA 5-15P
Full Load Amp.	7	7	7
Compressor HP	1/5	1/5	1/5
Refrigerant	R-600a	R-600a	R-600a
Cord Length (ft.)	9	9	9
DIMENSIONAL DATA			
Net Capacity (cu. ft.)	12.21	18.30	21.98
Ext. Dimension (L x D* x H†) (in.)	34 x 32 ⁷ / ₈ x 40 ⁵ / ₈	49 x 32 ⁷ / ₈ x 40 ⁵ / ₈	58 x 32 ⁷ / ₈ x 40 ⁵ / ₈
# of Doors	4	4	4
Crate Capacity (13" x 13" x 11")	8	12	16
Gross Weight (lbs.)	292	369	396

Design and specifications subject to change without notice. Most updated spec sheets are available at www.turboairinc.com.

Actual shipping weight may differ due to extra packing materials for product protection.

* Depth does not include 1-3/8" for door support bumpers. † Height does not include 1-1/4" for door handles and door support bumpers.

■ **WARRANTY: 5 Year Parts and Labor Warranty, 7 Year Compressor Warranty**

WARRANTY

Warranty Claims

All claims for parts or labor must be made directly through Turbo Air. All claims should include: model number of the unit, the serial number of the cabinet, proof of purchase, date of installation, and all pertinent information supporting the alleged defect. In case of compressor replacement under warranty, either compressor or compressor tag must be returned to Turbo Air along with above listed information. Failure to comply with warranty policies will result in voiding claims.

Up to Five-Year Parts & Labor Warranty

Turbo Air warrants all new refrigerated components, the cabinet and all parts, to be free from defects in materials or workmanship, under normal and proper use and maintenance service as specified by Turbo Air and upon proper installation* (indoor building only) and start-up in accordance with the instruction packet supplied with each Turbo air unit. Turbo Air's obligation under this warranty is limited to a period of one (1), two (2), three (3) years, or five (5) years depending on models from the date of original installation or fifteen (15) months, twenty seven (27) months, thirty nine (39) months, sixty three (63) months after shipment date from Turbo Air, whichever occurs first. Any part, covered under this warranty, that is by Turbo Air to have been found defective within one (1), two (2), three (3) years, or five (5) years of original installation or fifteen (15) months, twenty seven (27) months, thirty nine (39) months, sixty three (63) months after shipment date from manufacturer, whichever occurs first, is limited to the repair or replacement, including labor charges, of defective parts or assemblies. The labor warranty shall include standard straight time labor charges only and reasonable travel time, as determined by Turbo Air (*Installation in unstable, mobile, and enclosed area may not be considered as proper installation).

Parts and Labor Warranty Period by Model

- All Super Deluxe (SD) Series, PRO Series, M3 Series, Milk Coolers, Underbar Equipment: 5 years (Heated Cabinets: 3 Years)
- J-Series, Glass Door Products (Standard Series, E-line): 2 years
- Open Display, Bakery and Deli Cases, Ice Cream Dipping Cabinets, Sushi Cases (Refrigerated): 2 years

Up to Seven-Year Compressor Warranty †

In addition to the parts and labor warranty stated above, Turbo Air warrants its hermetically sealed compressor to be free from defects in both material and workmanship under normal and proper use and maintenance service for a period of two (2), three (3), or four (4) years, depending on models stated above, from the date of original installation, but not to exceed seven (7) years and three (3) months after shipment from the manufacturer. Compressor determined by Turbo Air to have been defective within this extended period will, at Turbo Air's discretion, be either repaired or replaced with a compressor or compressor parts of similar design and capacity.

The extended compressor part warranty applies only to hermetically sealed parts of the compressor and does not apply to any other parts or components, including, but not limited to, cabinet, paint finish, temperature control, refrigerant, metering device, driers, motor starting equipment, fan assembly and/or other electrical components, etcetera.

† Total seven-year compressor part warranty applies to PRO, Super Deluxe, and M3 Series models only.

R-290/R-600a Hydrocarbon Compressor Warranty

The two-year or four-year additional compressor warranty detailed above will be void if the following procedure is not carefully adhered to:

1. This system may contain R290 refrigerant and polyol ester lubricant. The polyol ester lubricant has rapid moisture absorbing qualities. If long exposure to the ambient conditions occur, the lubricant must be removed and replaced with new.
2. Drier replacement is very important and must be changed when a system is opened for servicing. Drier with XH-7 molecular sieve or better must be used.
3. Micron level vacuums must be achieved to ensure low moisture levels in the system. 500 microns or lower must be maintained.
4. Compressor must be obtained through Turbo Air, unless otherwise specified in writing, through Turbo Air's warranty department.

What is Not Covered by This Warranty

Turbo Air's sole obligation under this warranty is limited to either repair or replacement of parts, subject to the additional limitations below. This warranty neither assumes nor authorizes any person to assume obligations other than those expressly covered by this warranty.

NO CONSEQUENTIAL DAMAGES. TURBO AIR IS NOT RESPONSIBLE FOR ECONOMIC LOSS; PROFIT LOSS; OR SPECIAL, INDIRECT, OR CONSEQUENTIAL DAMAGES, INCLUDING WITHOUT LIMITATION, LOSSES, OR DAMAGES ARISING FROM FOOD OR PRODUCT SPOILAGE REGARDLESS OF WHETHER OR NOT THEY RESULT FROM REFRIGERATION FAILURE.

WARRANTY IS NOT TRANSFERABLE. This warranty is not assignable and applies only in favor of the original purchaser/user to whom delivered. ANY SUCH ASSIGNMENT OR TRANSFER SHALL VOID THE WARRANTIES HEREIN AND SHALL VOID ALL WARRANTIES, EXPRESS OR IMPLIED, INCLUDING ANY WARRANTY OF MERCHANTABILITY OR LABOR COVERAGE FOR COMPONENT FAILURE OR OTHER THE WARRANTY PACKET PROVIDED WITH THE UNIT. Turbo Air will not be held responsible for the following external factors: ALTERATION, NEGLIGENCE, ABUSE, MISUSE, ACCIDENT, DAMAGE DURING TRANSIT OR INSTALLATION, FIRE, FLOOD, ACTS OF GOD, OR IMPROPER ELECTRICAL CONNECTIONS. TURBO AIR IS NOT RESPONSIBLE FOR THE REPAIR OR REPLACEMENT OF FAILED OR DAMAGED COMPONENTS RESULTING FROM ELECTRICAL POWER FAILURE, THE USE OF EXTENSION CORDS, LOW VOLTAGE, OR VOLTAGE DROPS TO THE UNIT.

Use of NON-OEM parts without manufacturer's approval may void cabinet warranty. NO IMPLIED WARRANTY OF MERCHANTABILITY OR FITNESS FOR A PARTICULAR PURPOSE; THE FOREGOING WARRANTIES ARE EXCLUSIVE AND EXPRESSLY GIVEN IN LIEU OF ALL OTHER WARRANTIES, EXPRESSED, IMPLIED OR STATUTORY. THERE ARE NO WARRANTIES, WHICH EXTEND BEYOND THE DESCRIPTION ON THE FACE HEREOF.

Warranty information card must be submitted via post mail or electronically on our website at www.turboairinc.com/registration within 7 days from the purchase date. Failure to comply may result in your warranty being voided.

All coverage provided within this warranty is applicable only to the United States, including Alaska and Hawaii, and Canada, excluding U.S. Territories; limited parts only warranty in U.S. Territories. Turbo Air is not responsible for any warranty claims made on products sold or used outside the fifty states of the United States.

The extended warranty period specific to each Turbo Air product applies to all units sold by Turbo Air starting June 1, 2023.



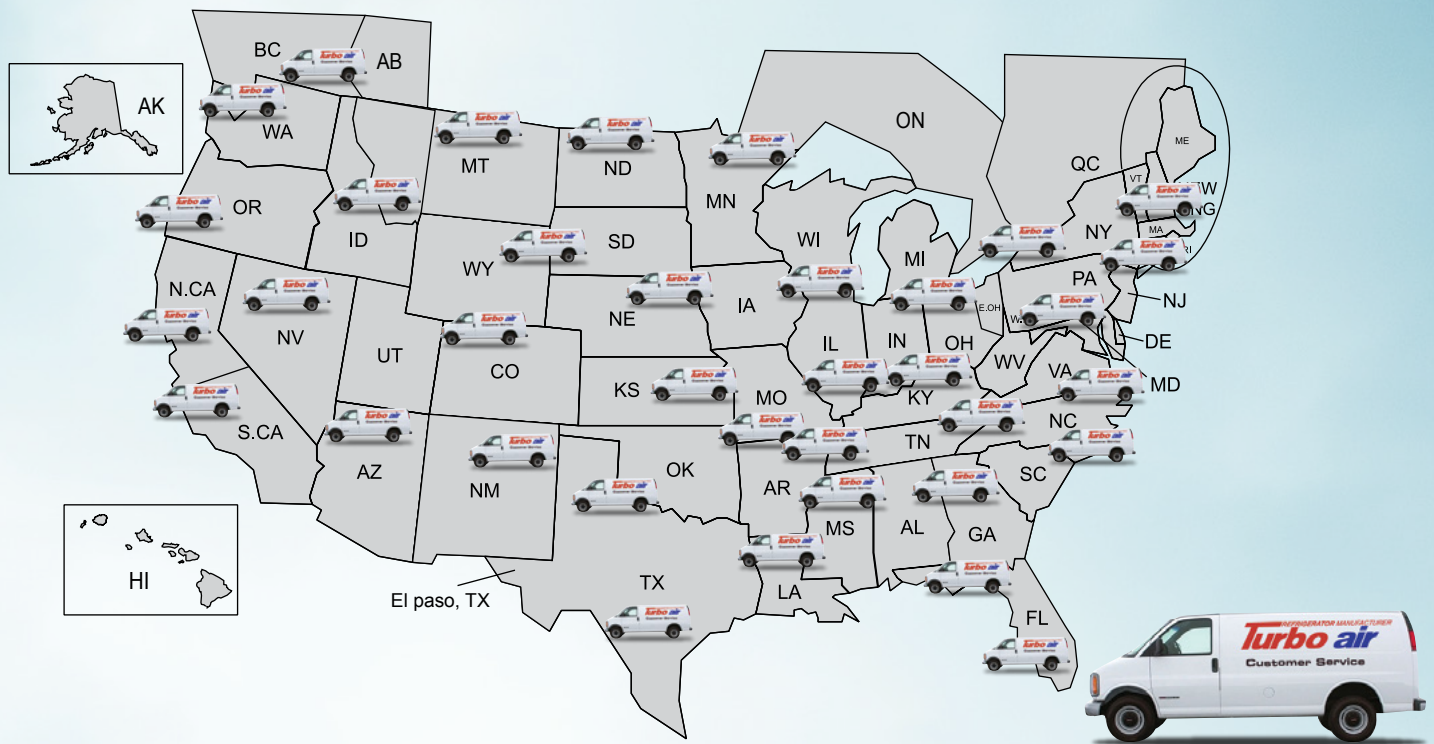

Fastest Warranty Service In the Industry

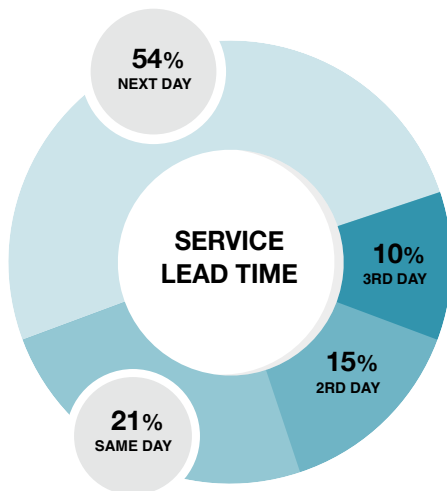

95% of service calls fulfilled within 3 business days.

We know the frustration and disappointment customers feel when their refrigerators are not promptly fixed. Our in-house technicians fulfill 95% of all service calls within three days and deliver two-day service parts throughout the United States.



Part Distribution

13 warehouses
15 major part distributors
2 Day delivery throughout the United States



In-house Technicians available in 17 locations

2,000 Technician Network



We are more than just a manufacturer, we know your business

Turbo Air offers prompt service expending substantial costs. We know that if a dealer is not quick to provide product service, there is a high risk of losing customers. We strongly believe that Turbo Air cannot succeed without the dealer's success.



Refrigeration System

Remote System

Unit Coolers
Condensing Units

Package System

SMART 7

Contact

888-900-1002

310-900-1080

Tacsvc@turboairinc.com

LOW PROFILE UNIT COOLERS



LOW PROFILE UNIT COOLER STANDARD FEATURES

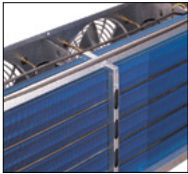

- Blue anti-corrosion-fin increases the life span of the coil.
- Air-pass guard is located at the bottom of the coil to improve heat exchange rate.
- Easy to replace defrost heater (LED model).
- Corrugated fin is used to increase heat exchange rate by expanding the surface area.

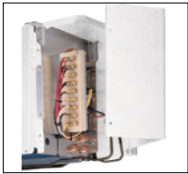

- Even in confined space, all parts can be reached easily by opening the front cover.
- Location of power connector makes replacement of motor convenient.
- **1 Year fan motor and parts warranty!**

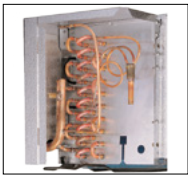

- Seamless inner groove copper tube increases the heat exchange rate by reducing the space between the fin and the copper tube.
- Venturi type distributor and precise orifice hole are used to minimize the pressure drop and maximize the freezing capacity respectively.
- Even in confined space, all parts can be reached easily by opening the front cover.

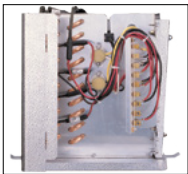

- Thermostat is installed to prevent over temperature on heater.
- Circuit opens automatically over 70°F.
- Parts available: Expansion Valve (**Sporlan**) (**Factory Pre-mounted**)
Solenoid Valve (**Sporlan**) (**Factory Pre-mounted**)
Thermostat (**Johnson Control**) (**Shipped Loose**)



- The spiral fan guard enables cold air to be delivered efficiently and thoroughly.
- The protruding fan and motor placement substantially reduce vibration and noise.
- **EC motor (Dual Speed & Dual Voltage) for high energy efficiency.**
- Switching relay pre-installed to control motors RPM.



- Anti-oxidizing stainless steel mounting and bolts.

All Replacement Parts are Universal!

LOW PROFILE UNIT COOLERS

DIMENSIONAL DATA

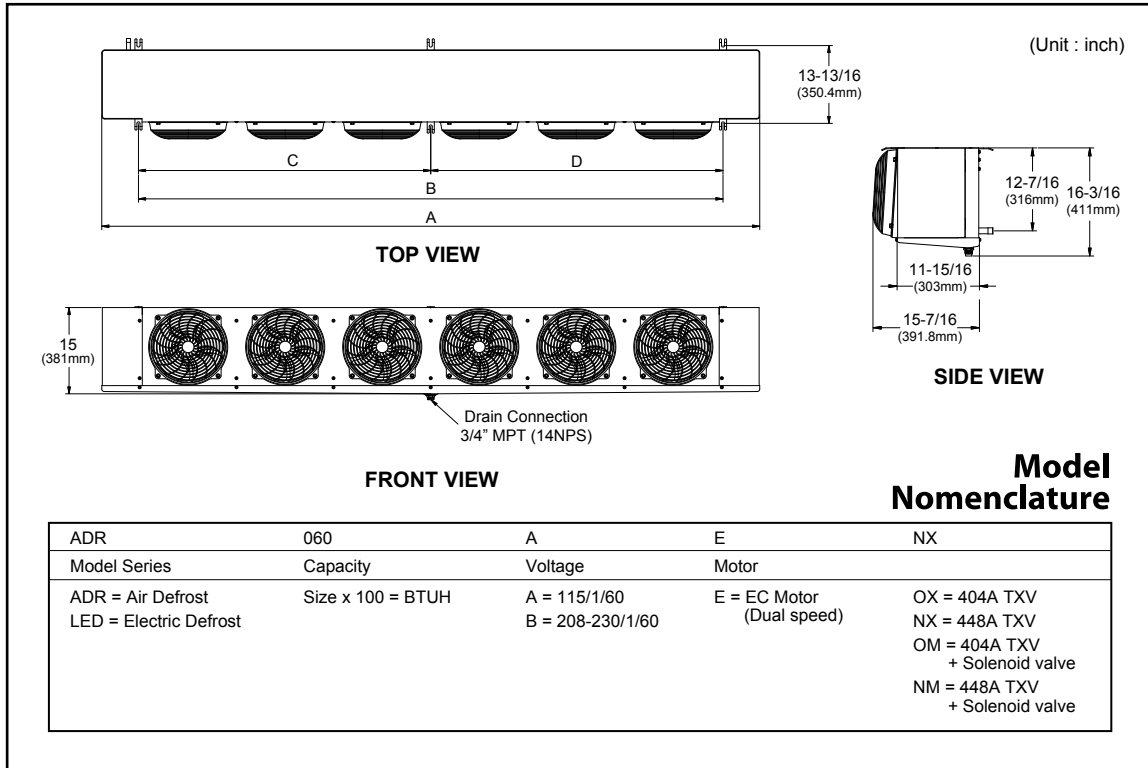

DIMENSIONAL DATA FOR ADR/LED MODELS

Air Defrost Models 6 FPI	Electric Defrost Models 6 FPI	No. of Fans	Dimensions (Inches / mm)						Approx. Net Wt. (lbs / kg)			
			A		B		C		D		ADR	LED
ADR060AE	LED036BE	1	29.4	747.4	17.4	443				30 / 14	32 / 15	
	LED052BE	2	45.4	1154.4	33.5	850					48 / 22	
ADR089AE		2	45.4	1154.4	33.5	850				45 / 20		
ADR112AE	LED072BE	2	45.4	1154.4	33.5	850				48 / 22	52 / 24	
ADR125AE	LED081BE	2	45.4	1154.4	33.5	850				49 / 22	53 / 24	
ADR137AE	LED090BE	3	61.4	1559.4	49.4	1255				62 / 28	67 / 31	
ADR171AE	LED114BE	3	61.4	1559.4	49.4	1255				67 / 30	73 / 33	
ADR191AE		3	61.4	1559.4	49.4	1255				68 / 31		
	LED124BE	4	77.4	1966.4	65.4	1662					86 / 39	
	LED157BE	4	77.4	1966.4	65.4	1662					93 / 42	
ADR258AE	LED176BE	4	77.4	1966.4	65.4	1662				87 / 40	95 / 43	
ADR325AE	LED225BE	5	93.5	2374.4	81.5	2070				105 / 48	116 / 52	
ADR352AE	LED244BE	6	109.5	2782.4	97.6	2478	49.0	1244	48.6	1234	124 / 56	134 / 61
ADR392AE	LED273BE	6	109.5	2782.4	97.6	2478	49.0	1244	48.6	1234	127 / 58	137 / 62

LOW PROFILE UNIT COOLERS



SPECIFICATIONS & PHYSICAL DATA

ADR Air Defrost Models 60Hz. With EC Motors (Dual Speed & Dual Voltage)

Model	EC Motor Data			Connections (Inches)				Approx. Net Weight	
	115V 1Ph 60Hz								
	HP	Total Amps	Watts	COIL INLET	SUCTION	EQUALIZER	DRAIN	Lbs	Kg
ADR060AE	1/25	0.75	25	1/2 OD	5/8 ID	1/4 OD	3/4 MPT	30	14
ADR089AE	1/25	1.50	50	1/2 OD	5/8 ID	1/4 OD	3/4 MPT	45	20
ADR112AE	1/25	1.50	50	1/2 OD	5/8 ID	1/4 OD	3/4 MPT	48	22
ADR125AE	1/25	1.50	50	1/2 OD	7/8 ID	1/4 OD	3/4 MPT	49	22
ADR137AE	1/25	2.25	75	1/2 OD	7/8 ID	1/4 OD	3/4 MPT	62	28
ADR171AE	1/25	2.25	75	1/2 OD	7/8 ID	1/4 OD	3/4 MPT	67	30
ADR191AE	1/25	2.25	75	1/2 OD	7/8 ID	1/4 OD	3/4 MPT	68	31
ADR258AE	1/25	3.00	100	1/2 OD	7/8 ID	1/4 OD	3/4 MPT	87	40
ADR325AE	1/25	3.75	125	1/2 OD	1-1/8 ID	1/4 OD	3/4 MPT	105	48
ADR352AE	1/25	4.50	150	1/2 OD	1-1/8 ID	1/4 OD	3/4 MPT	124	56
ADR392AE	1/25	4.50	150	1/2 OD	1-1/8 ID	1/4 OD	3/4 MPT	127	58

LED Electric Defrost Models 60Hz. With EC Motors (Dual Speed & Dual Voltage)

Model	EC Motor Data			Defrost Heaters			Connections (Inches)				Approx. Net Weight	
	230V 1Ph 60Hz			Watts	Total Amps							
	HP	Total Amps	Watts		230/1/60	230/3/60	COIL INLET	SUCTION	EQUALIZER	DRAIN	Lbs	Kg
LED036BE	1/25	0.45	25	1020	4.4	2.6	1/2 OD	5/8 ID	1/4 OD	3/4 MPT	32	15
LED052BE	1/25	0.90	50	2010	8.7	5.0	1/2 OD	5/8 ID	1/4 OD	3/4 MPT	48	22
LED072BE	1/25	0.90	50	2010	8.7	5.0	1/2 OD	5/8 ID	1/4 OD	3/4 MPT	52	24
LED081BE	1/25	0.90	50	2010	8.7	5.0	1/2 OD	7/8 ID	1/4 OD	3/4 MPT	53	24
LED090BE	1/25	1.35	75	3000	13.0	7.5	1/2 OD	7/8 ID	1/4 OD	3/4 MPT	67	31
LED114BE	1/25	1.35	75	3000	13.0	7.5	1/2 OD	7/8 ID	1/4 OD	3/4 MPT	73	33
LED124BE	1/25	1.80	100	3900	17.0	9.8	1/2 OD	7/8 ID	1/4 OD	3/4 MPT	86	39
LED157BE	1/25	1.80	100	3900	17.0	9.8	1/2 OD	1-1/8 ID	1/4 OD	3/4 MPT	93	42
LED176BE	1/25	1.80	100	3900	17.0	9.8	1/2 OD	1-1/8 ID	1/4 OD	3/4 MPT	95	43
LED225BE	1/25	2.25	125	4800	20.9	12.0	1/2 OD	1-1/8 ID	1/4 OD	3/4 MPT	116	52
LED244BE	1/25	2.70	150	6000	26.1	15.1	1/2 OD	1-1/8 ID	1/4 OD	3/4 MPT	134	61
LED273BE	1/25	2.70	150	6000	26.1	15.1	1/2 OD	1-1/8 ID	1/4 OD	3/4 MPT	137	62

LOW PROFILE UNIT COOLERS



AIR DEFROST PERFORMANCE DATA

ADR Air Defrost Models 60Hz. With EC Motors (Dual Speed & Dual Voltage)

Model	Capacity (R-404A)*				Capacity (R-448A / R-449A)*				Fan Data		
	10°F / 6°C TD 25°F / -4°C SST		14°F / 8°C TD 21°F / -6°C SST		10°F / 6°C TD 25°F / -4°C SST		14°F / 8°C TD 21°F / -6°C SST		CFM / m ³ H	No.	
	BTUH	Watts	BTUH	Watts	BTUH	Watts	BTUH	Watts			
ADR060AE	6058	1774	7906	2315	6022	1764	7853	2300	772	1312	1
ADR089AE	8989	2633	11756	3443	8947	2620	11694	3425	1555	2643	2
ADR112AE	11280	3304	14763	4324	11234	3290	14694	4303	1544	2623	2
ADR125AE	12609	3693	16511	4836	12561	3679	16439	4815	1544	2623	2
ADR137AE	13744	4025	18008	5274	13697	4011	17936	5253	2333	3964	3
ADR171AE	17213	5041	22565	6609	17159	5025	22484	6585	2316	3935	3
ADR191AE	19213	5627	25197	7379	19157	5611	25113	7355	2316	3935	3
ADR258AE	25883	7580	33974	9950	25821	7562	33882	9923	3088	5247	4
ADR325AE	32584	9543	42795	12534	32519	9524	42697	12505	3860	6559	5
ADR352AE	35287	10335	46354	13576	35220	10315	46253	13546	4632	7870	6
ADR392AE	39317	11515	51659	15130	39248	11495	51556	15099	4632	7870	6

ELECTRIC DEFROST PERFORMANCE DATA

LED Electric Defrost Models 60Hz. With EC Motors (Dual Speed & Dual Voltage)

Model	Capacity (R-404A)*				Capacity (R-448A)*				Fan Data		
	10°F / 6°C TD -20°F / -29°C SST		12°F / 7°C TD -22°F / -30°C SST		10°F / 6°C TD -20°F / -29°C SST		12°F / 7°C TD -22°F / -30°C SST		CFM / m ³ H	No.	
	BTUH	Watts	BTUH	Watts	BTUH	Watts	BTUH	Watts			
LED036BE	3764	1102	4432	1298	3678	1077	4325	1267	772	1312	1
LED052BE	5351	1567	6312	1849	5247	1537	6183	1811	1555	2643	2
LED072BE	7369	2158	8703	2549	7244	2121	8546	2503	1544	2623	2
LED081BE	8313	2435	9823	2877	8181	2396	9657	2828	1544	2623	2
LED090BE	9161	2683	10831	3172	9027	2644	10663	3123	2333	3964	3
LED114BE	11587	3393	13708	4015	11431	3348	13513	3958	2316	3935	3
LED124BE	12608	3693	14924	4371	12454	3647	14731	4314	3111	5285	4
LED157BE	15901	4657	18832	5515	15723	4605	18610	5450	3088	5247	4
LED176BE	17842	5225	21139	6191	17657	5171	20907	6123	3088	5247	4
LED225BE	22711	6651	26926	7886	22509	6592	26672	7812	3860	6559	5
LED244BE	24664	7224	29248	8566	24456	7162	28986	8489	4632	7870	6
LED273BE	27609	8086	32750	9592	27392	8023	32478	9512	4632	7870	6

*Cooling capacity calculation (Condensing temperature = 105°F, Superheat = 6.5°F, Subcooling = 9°F)

THIN PROFILE COOLERS

MODEL NOMENCLATURE

TTA	085	A	E	NX
Model Series	Capacity	Voltage	MOTOR	
TTA = Air Defrost TTE = Electric Defrost	Size x 100 = BTUH	A = 115/1/60 B = 208-230/1/60	E = EC Motor (Dual speed)	OX = 404A TXV NX = 448A TXV OM = 404A TXV + Solenoid valve NM = 448A TXV + Solenoid valve



SPECIFICATIONS & PHYSICAL DATA

TTA Air Defrost Models 60Hz. With EC Motors (Dual Speed & Dual Voltage)

Model	EC Motor Data			Connections (Inches)				Approx. Net Weight	
	115V 1Ph 60Hz			COIL INLET	SUCTION	EQUALIZER	DRAIN	Lbs	Kg
	HP	Total Amps	Watts						
TTA085AE	1/25	1.50	50	1/2 OD	5/8 ID	1/4 OD	3/4 MPT	44	20
TTA130AE	1/25	2.25	75	1/2 OD	5/8 ID	1/4 OD	3/4 MPT	61	28
TTA176AE	1/25	3.00	100	1/2 OD	7/8 ID	1/4 OD	3/4 MPT	80	36
TTA221AE	1/25	3.75	125	1/2 OD	7/8 ID	1/4 OD	3/4 MPT	97	44
TTA248AE	1/25	4.50	150	1/2 OD	1-1/8 ID	1/4 OD	3/4 MPT	115	52

TTE Electric Defrost Models 60Hz. With EC Motors (Dual Speed & Dual Voltage)

Model	EC Motor Data			Defrost Heaters		Connections (Inches)				Approx. Net Weight	
	230V 1Ph 60Hz			Watts	Total Amps	COIL INLET	SUCTION	EQUALIZER	DRAIN	Lbs	Kg
	HP	Total Amps	Watts		230/1/60						
TTE064BE	1/25	0.90	50	1110	4.8	1/2 OD	5/8 ID	1/4 OD	3/4 MPT	45	20
TTE102BE	1/25	1.35	75	1530	6.7	1/2 OD	5/8 ID	1/4 OD	3/4 MPT	62	28
TTE140BE	1/25	1.80	100	1950	8.5	1/2 OD	7/8 ID	1/4 OD	3/4 MPT	81	37
TTE179BE	1/25	2.25	125	2370	10.3	1/2 OD	7/8 ID	1/4 OD	3/4 MPT	99	45
TTE203BE	1/25	2.70	150	2790	12.1	1/2 OD	1-1/8 ID	1/4 OD	3/4 MPT	116	53

THIN PROFILE COOLERS

PERFORMANCE DATA

TTA Air Defrost Models 60Hz. With EC Motors (Dual Speed & Dual Voltage)

Model	Capacity (R-404A)*				Capacity (R-448A / R-449A)*				Fan Data		
	10°F / 6°C TD		14°F / 8°C TD		10°F / 6°C TD		14°F / 8°C TD				
	25°F / -4°C SST		21°F / -6°C SST		25°F / -4°C SST		21°F / -6°C SST		CFM/m³/h	No.	
	BTUH	Watts	BTUH	Watts	BTUH	Watts	BTUH	Watts			
TTA085AE	8535	2500	12502	3662	8502	2490	12447	3645	1487	2527	2
TTA130AE	13053	3823	19151	5609	13014	3812	19086	5590	2231	3791	3
TTA176AE	17595	5153	25840	7568	17553	5141	25769	7547	2975	5054	4
TTA221AE	22151	6487	32551	9533	22106	6474	32476	9511	3719	6318	5
TTA248AE	24887	7289	36583	10714	24841	7275	36504	10691	4462	7582	6

TTE Electric Defrost Models 60Hz. With EC Motors (Dual Speed & Dual Voltage)

Model	Capacity (R-404A)*				Capacity (R-448A)*				Fan Data		
	10°F / 6°C TD		12°F / 7°C TD		10°F / 6°C TD		12°F / 7°C TD				
	-20°F / -29°C SST		-22°F / -30°C SST		-20°F / -29°C SST		-22°F / -30°C SST		CFM/m³/h	No.	
	BTUH	Watts	BTUH	Watts	BTUH	Watts	BTUH	Watts			
TTE064BE	6570	1924	8070	2363	6457	1891	7924	2321	1487	2527	2
TTE102BE	10369	3037	12760	3737	10230	2996	12579	3684	2231	3791	3
TTE140BE	14240	4171	17543	5138	14082	4124	17336	5077	2975	5054	4
TTE179BE	18152	5316	22378	6554	17978	5265	22151	6487	3719	6318	5
TTE203BE	20508	6006	25292	7407	20326	5953	25054	7338	4462	7582	6

*Cooling capacity calculation (Condensing temperature = 105°F, Superheat = 6.5°F, Subcooling = 9°F)

Dimensional Data For All Models

Air Defrost Models 6 FPI	Electric Defrost Models 6 FPI	No. of Fans	Dimensions (Inches / mm)							
			A		B		C		D	
			Inch	mm	Inch	mm	Inch	mm	Inch	mm
TTA085AE	TTE064BE	2	49.7	1262	40.8	1037	-	-	-	-
TTA130AE	TTE102BE	3	69.4	1764	60.6	1539	-	-	-	-
TTA176AE	TTE140BE	4	89.2	2266	80.4	2041	40.9	1038	-	-
TTA221AE	TTE179BE	5	109.0	2768	100.1	2543	40.9	1038	-	-
TTA248AE	TTE203BE	6	128.7	3270	119.9	3045	40.9	1038	39.5	1003

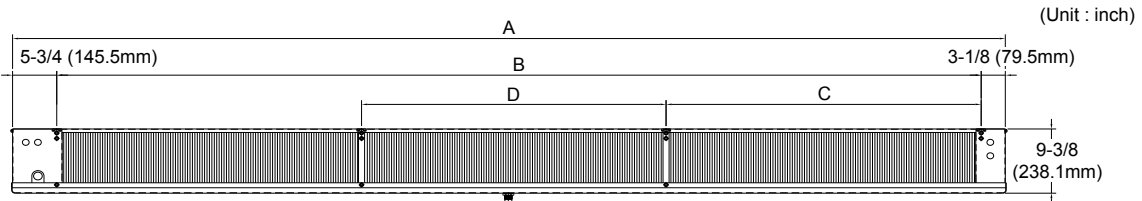

FRONT VIEW

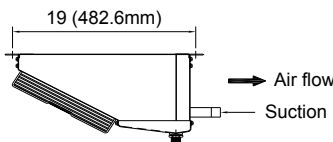

SIDE VIEW

CENTER MOUNT COOLERS

MODEL NOMENCLATURE

TCA	084	A	E	NX
Model Series	Capacity	Voltage	Motor	
TCA = Air Defrost TCE = Electric Defrost	Size x 100 = BTUH	A = 115/1/60 B = 208-230/1/60	E = EC Motor (1 speed)	OX = 404A TXV NX = 448A TXV OM = 404A TXV + Solenoid valve NM = 448A TXV + Solenoid valve



SPECIFICATIONS & PHYSICAL DATA

TCA Air Defrost Models 60Hz. With EC Motors (1 Speed & Dual Voltage)

Model	EC Motor Data			Connections (Inches)				Approx. Net Weight	
	115V 1Ph 60Hz			COIL INLET	SUCTION	EQUALIZER	DRAIN	Lbs	Kg
	HP	Total Amps	Watts						
TCA084AE	1/20	0.72	55	1/2 OD	7/8 OD	1/4 OD	3/4 MPT	66	30
TCA113AE	1/20	0.72	55	1/2 OD	7/8 OD	1/4 OD	3/4 MPT	86	39
TCA187AE	1/20	1.44	110	1/2 OD	7/8 OD	1/4 OD	3/4 MPT	108	49
TCA207AE	1/20	1.44	110	1/2 OD	1-1/8 OD	1/4 OD	3/4 MPT	137	62
TCA249AE	1/20	1.44	110	1/2 OD	1-1/8 OD	1/4 OD	3/4 MPT	141	64
TCA285AE	1/20	2.16	165	1/2 OD	1-1/8 OD	1/4 OD	3/4 MPT	150	68
TCA338AE	1/20	2.88	220	1/2 OD	1-1/8 OD	1/4 OD	3/4 MPT	187	85
TCA381AE	1/20	2.88	220	1/2 OD	1-3/8 OD	1/4 OD	3/4 MPT	192	87
TCA477AE	1/20	3.60	275	1/2 OD	1-3/8 OD	1/4 OD	3/4 MPT	231	105

TCE Electric Defrost Models 60Hz. With EC Motors (1 Speed & Dual Voltage)

Model	EC Motor Data			Defrost Heaters		Connections (Inches)				Approx. Net Weight	
	230V 1Ph 60Hz			Watts	Total Amps	COIL INLET	SUCTION	EQUALIZER	DRAIN	Lbs	Kg
	HP	Total Amps	Watts		230/1/60						
TCE066BE	1/20	0.72	55	2120	9.2	1/2 OD	7/8 OD	1/4 OD	3/4 MPT	67	30
TCE093BE	1/20	0.72	55	3020	13.1	1/2 OD	7/8 OD	1/4 OD	3/4 MPT	87	39
TCE156BE	1/20	1.44	110	3020	13.1	1/2 OD	7/8 OD	1/4 OD	3/4 MPT	109	49
TCE175BE	1/20	1.44	110	4200	18.3	1/2 OD	1-1/8 OD	1/4 OD	3/4 MPT	138	63
TCE214BE	1/20	1.44	110	4200	18.3	1/2 OD	1-1/8 OD	1/4 OD	3/4 MPT	143	65
TCE241BE	1/20	2.16	165	4200	18.3	1/2 OD	1-1/8 OD	1/4 OD	3/4 MPT	151	69
TCE288BE	1/20	2.88	220	5480	23.8	1/2 OD	1-1/8 OD	1/4 OD	3/4 MPT	189	86
TCE325BE	1/20	2.88	220	5480	23.8	1/2 OD	1-3/8 OD	1/4 OD	3/4 MPT	194	88
TCE410BE	1/20	3.60	275	6720	29.2	1/2 OD	1-3/8 OD	1/4 OD	3/4 MPT	234	106

CENTER MOUNT COOLERS

PERFORMANCE DATA

TCA Air Defrost Models 60Hz. With EC Motors (1 Speed & Dual Voltage)

Model	Capacity (R-404A)*				Capacity (R-448A / R-449A)*				Fan Data		
	10°F / 6°C TD		14°F / 8°C TD		10°F / 6°C TD		14°F / 8°C TD		CFM/m³H	No.	
	25°F / -4°C SST		21°F / -6°C SST		25°F / -4°C SST		21°F / -6°C SST				
	BTUH	Watts	BTUH	Watts	BTUH	Watts	BTUH	Watts			
TCA084AE	8431	2469	12370	3623	8407	2462	12329	3611	1118	1899	1
TCA113AE	11352	3325	16685	4887	11330	3318	16648	4876	1126	1913	1
TCA187AE	18827	5514	27690	8110	18798	5505	27641	8095	2240	3806	2
TCA207AE	20761	6080	30557	8949	20738	6073	30517	8938	2252	3826	2
TCA249AE	24986	7318	36785	10773	24962	7311	36744	10761	2252	3826	2
TCA285AE	28475	8340	41911	12275	28443	8330	41857	12259	3360	5709	3
TCA338AE	33843	9912	49824	14592	33809	9902	49767	14576	4480	7611	4
TCA381AE	38137	11169	56155	16446	38103	11159	56096	16429	4480	7611	4
TCA477AE	47796	13998	70395	20617	47760	13988	70333	20599	5600	9514	5

TCE Electric Defrost Models 60Hz. With EC Motors (1 Speed & Dual Voltage)

Model	Capacity (R-404A)*				Capacity (R-448A)*				Fan Data		
	10°F / 6°C TD		12°F / 7°C TD		10°F / 6°C TD		12°F / 7°C TD		CFM/m³H	No.	
	-20°F / -29°C SST		-22°F / -30°C SST		-20°F / -29°C SST		-22°F / -30°C SST				
	BTUH	Watts	BTUH	Watts	BTUH	Watts	BTUH	Watts			
TCE066BE	6731	1971	8282	2426	6640	1945	8164	2391	1118	1899	1
TCE093BE	9398	2752	11588	3394	9311	2727	11475	3361	1126	1913	1
TCE156BE	15793	4625	19490	5708	15675	4591	19336	5663	2240	3806	2
TCE175BE	17697	5183	21860	6402	17597	5154	21729	6364	2252	3826	2
TCE214BE	21415	6272	26463	7750	21311	6241	26325	7710	2252	3826	2
TCE241BE	24247	7101	29952	8772	24113	7062	29776	8721	3360	5709	3
TCE288BE	28959	8481	35784	10480	28817	8440	35598	10426	4480	7611	4
TCE325BE	32738	9588	40461	11850	32591	9545	40269	11794	4480	7611	4
TCE410BE	41243	12079	50991	14934	41087	12033	50785	14874	5600	9514	5

Dimensional Data For for TCA/TCE Models

Air Defrost Models 6 FPI	Electric Defrost Models 6 FPI	No. of Fans	Dimensions (Inches / mm)											
			A		B		C		D		E		F	
			Inch	mm	Inch	mm	Inch	mm	Inch	mm	Inch	mm	Inch	mm
TCA084AE	TCE066BE	1	57.3	1456.0	45.3	1150.4	-	-	-	-	6.7	171.3	7.9	201.3
TCA113AE	TCE093BE	1	79.3	2015.0	67.3	1709.4	-	-	-	-	6.7	171.3	7.9	201.3
TCA187AE	TCE156BE	2	79.3	2015.0	67.3	1709.4	33.6	854.7	-	-	9.2	234.8	10.4	264.8
TCA207AE	TCE175BE	2	79.3	2015.0	67.3	1709.4	33.6	854.7	-	-	13.0	330.0	14.2	360.0
TCA249AE	TCE214BE	2	79.3	2015.0	67.3	1709.4	33.6	854.7	-	-	13.0	330.0	14.2	360.0
TCA285AE	TCE241BE	3	79.3	2015.0	67.3	1709.4	22.7	575.6	22.0	558.4	13.0	330.0	14.2	360.0
TCA338AE	TCE288BE	4	101.3	2574.0	89.3	2268.4	22.7	575.6	22.0	558.4	13.0	330.0	14.2	360.0
TCA381AE	TCE325BE	4	101.3	2574.0	89.3	2268.4	22.7	575.6	22.0	558.4	13.0	330.0	14.2	360.0
TCA477AE	TCE410BE	5	123.3	3132.0	111.3	2826.4	22.7	575.6	22.0	558.4	13.0	330.0	14.2	360.0

*Cooling capacity calculation (Condensing temperature = 105°F, Superheat = 6.5°F, Subcooling = 9°F)

(Unit : inch)

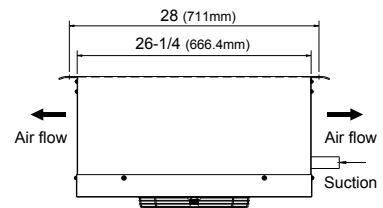
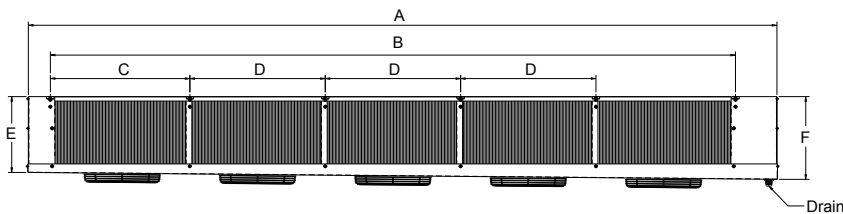

CONDENSING UNITS

CONDENSING UNIT STANDARD FEATURES



- Blue anti-corrosion fin increases the life span of the coil.
- Seamless inner groove copper tube is used to increase the heat exchange rate by reducing the space between the fin and the copper tube.



- Highest quality compressor in the world.



- 1 year compressor warranty (4 year extended warranty available).
- 1 year fan motor and parts warranty.



- Condenser Fan ON/OFF switch controls a condenser fan to keep condensing pressure constant in low ambient for stable operation, minimize formation of flash gas, and prevent compressor damage by controlling high pressure.
- Experienced engineers have designed the system for maximum efficiency.
- Fan blades: Specifically matched with motors and coil for maximum air movement and cooling.



- Control box is designed for easy installation.
- Auto-Reset dual pressure control (Low and High) is adjustable.
- All the parts are compliant with industry standards and interchangeable with readily available parts.
- Wiring: Easily accessible. Compressor comes with a wiring harness that is manufactured with connections that will not come loose with vibration.

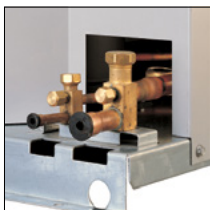

- Control box and service valves are located outside for easy service.
- Base: Heavy duty steel. Legs are 2-1/6" tall.
- Cabinet: Prepainted with galvanized body. Protects against corrosion.
- All products carry UL, cUL, ISO 9001 approvals.



All Replacement Parts are Universal!

CONDENSING UNITS

DIMENSIONAL DATA

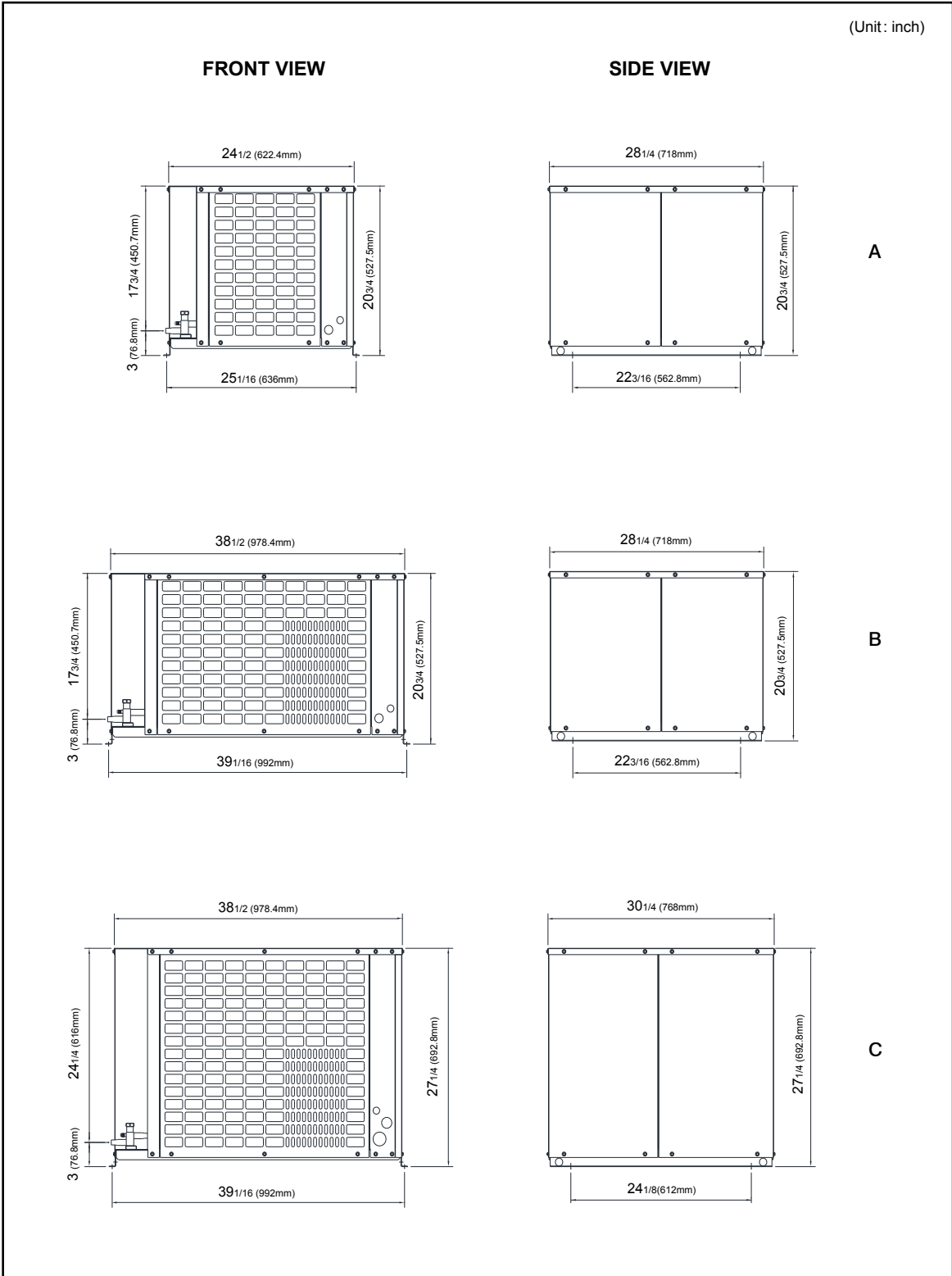

CONDENSING UNITS

DIMENSIONAL DATA

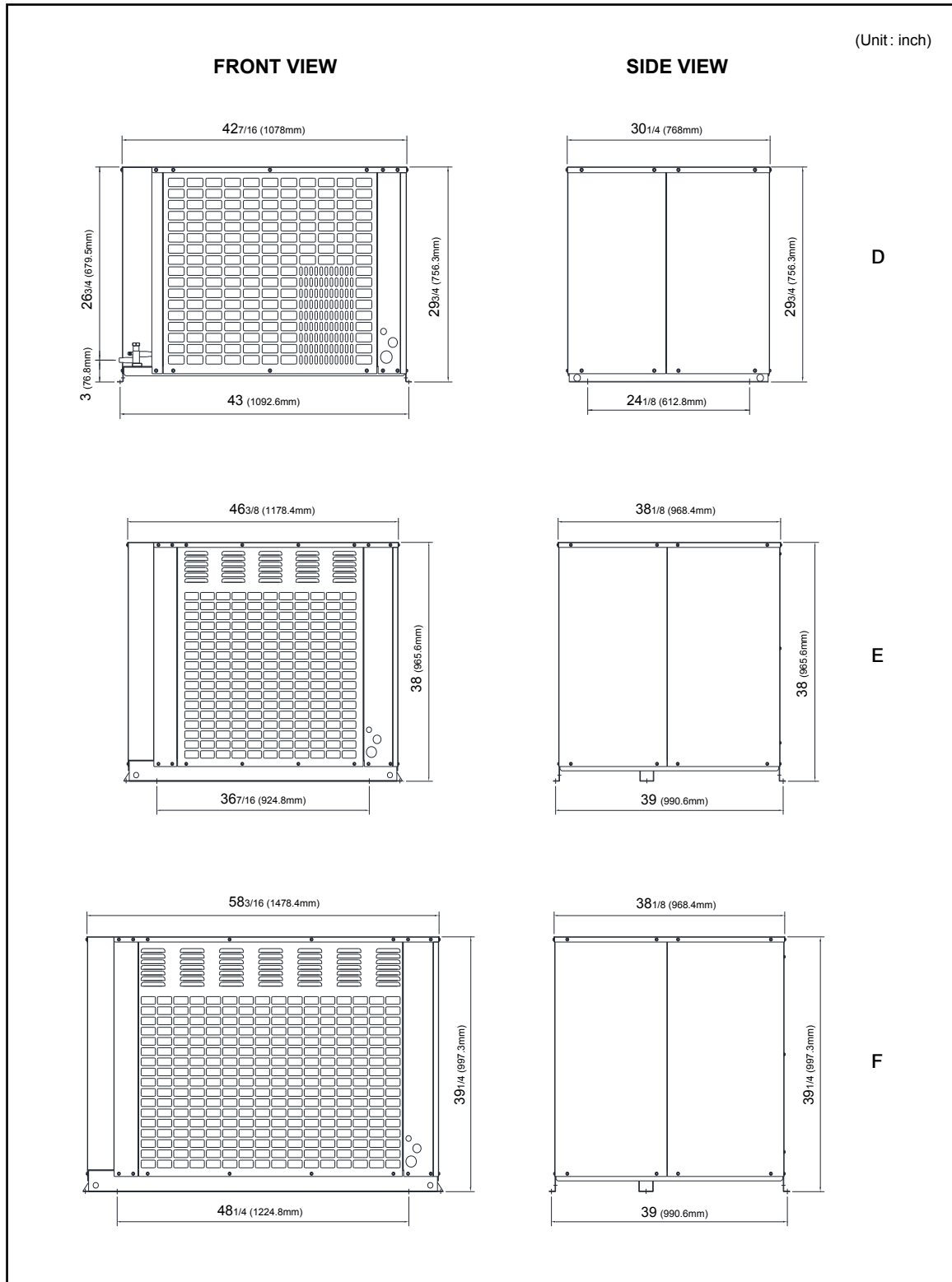

CONDENSING UNITS

DIMENSIONAL DATA

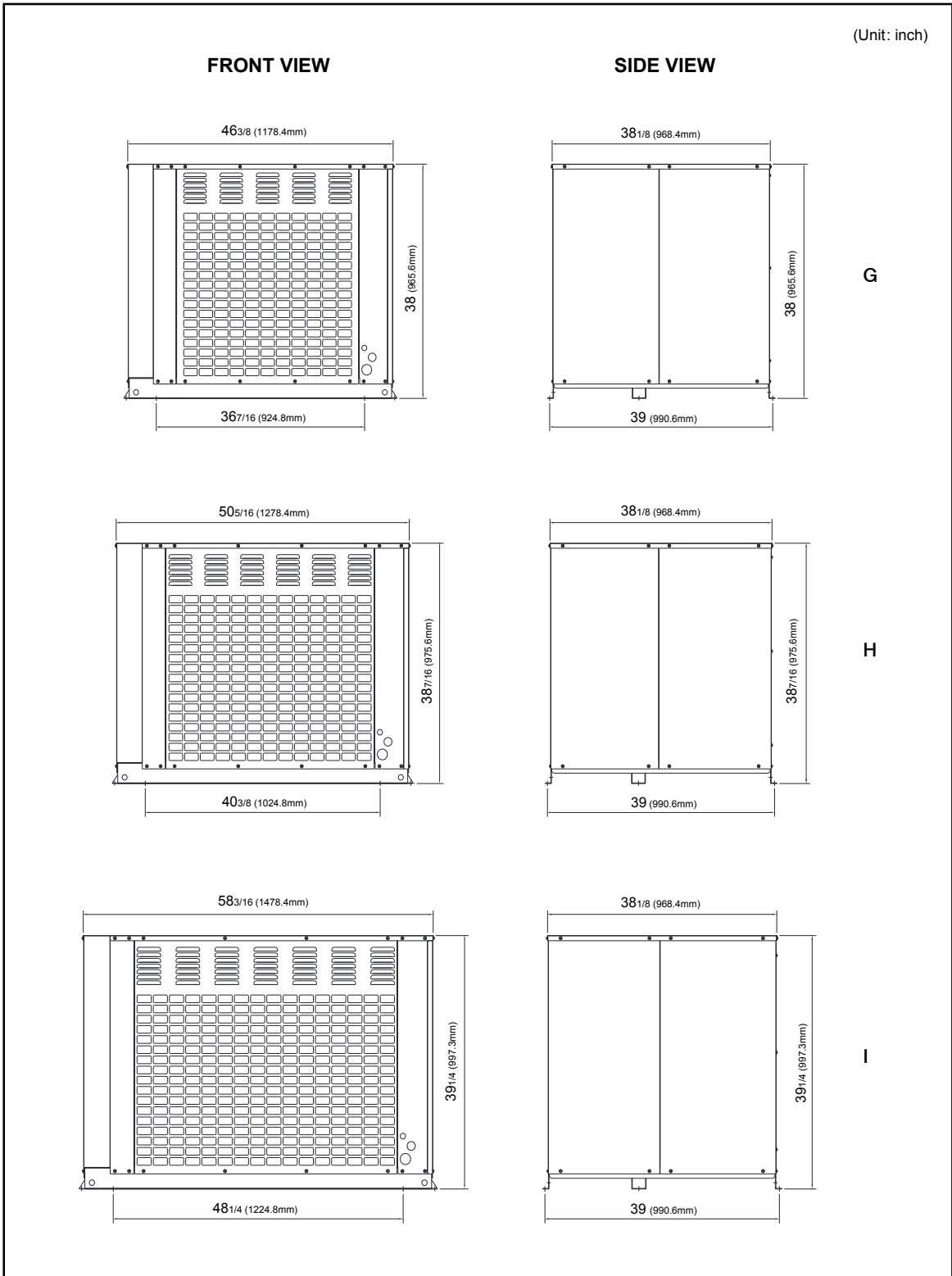

CONDENSING UNITS

R448A/449A

MODEL NOMENCLATURE

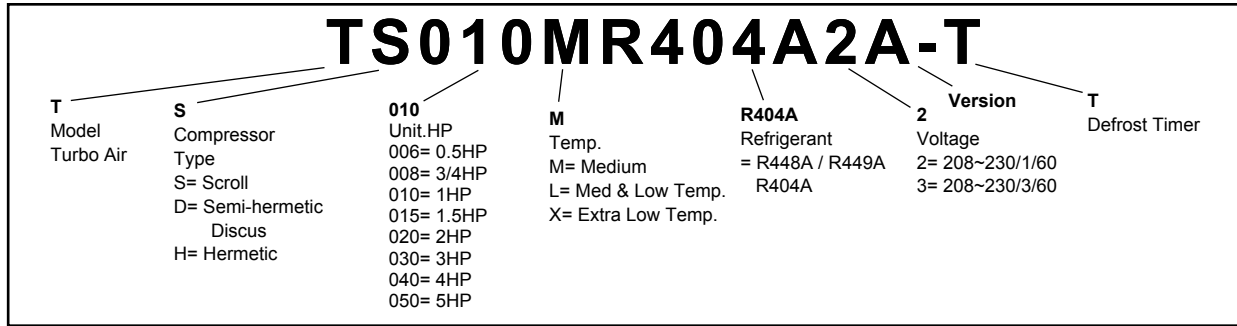

UNIT SPEC (MEDIUM TEMP.) : SCROLL COMPRESSORS

Model	Fig. *	Copeland [®] Compressor	Connections (ID)		Receiver 90% Full (lbs)	Fan(s) Data		Dimensions			Net Weight (lbs)	Sound dBA**	AWEF
			Liquid	Suction		CFM	No.	W (in.)	D (in.)	H (in.)			
TS006MR404A#†-T	A	ZB06KAE	3/8"	5/8"	8	1503	1	28.25	24.5	20.75	174	68	7.6 / 7.6
TS008MR404A#†-T	A	ZB08KAE	3/8"	5/8"	8	1503	1	28.25	24.5	20.75	173	68	7.6 / 7.6
TS010MR404A#†-T	A	ZS09KAE	3/8"	5/8"	8	1503	1	28.25	24.5	20.75	176	68	7.6 / 7.6
TS015MR404A#†-T	B	ZS13KAE	1/2"	7/8"	15	2936	2	28.25	38.5	20.75	234	68	7.6 / 7.6
TS020MR404A#†-T	B	ZS15KAE	1/2"	7/8"	15	2936	2	28.25	38.5	20.75	234	68	7.6 / 7.6
TS025MR404A#†-T	B	ZS19KAE	1/2"	7/8"	15	2936	2	28.25	38.5	20.75	234	68	7.6 / 7.6
TS030MR404A#†-T	C	ZS21KAE	1/2"	7/8"	18	3794	1	30.25	38.5	27.25	285	74	7.6 / 7.6
TS040MR404A#†-T	C	ZS29KAE	1/2"	1-1/8"	18	3764	1	30.25	38.5	27.25	306	74	7.6 / 7.6
TS050MR404A#†-T	D	ZS38K4E	1/2"	1-1/8"	18	3809	1	30.25	42.4	29.75	347	76	7.6 / 7.6
TS060MR404A#†-T	D	ZS45K4E	1/2"	1-1/8"	18	3809	1	30.25	42.4	29.75	354	78	7.6 / 7.6
TS075MR404A#†-T	F	ZB66K5E	5/8"	1-3/8"	31	7557	2	38.1	58.2	39.25	624	81	7.6 / 7.6
TS100MR404A#†-T	F	ZB95K5E	5/8"	1-3/8"	43	7557	2	38.1	58.2	39.25	647	82	7.6 / 7.6

** : Sound pressure are measured 10 feet from the product.
 Note: # = Phase, 2 = 1Ph 208~230V 60Hz, 3 = 3Ph 208~230V 60Hz / †: Version (A, B, ~) / T: defrost timer

UNIT SPEC (EXTRA LOW TEMP.) : SCROLL COMPRESSORS

Model	Fig. *	Copeland [®] Compressor	Connections (ID)		Receiver 90% Full (lbs)	Fan(s) Data		Dimensions			Net Weight (lbs)	Sound dBA**	AWEF
			Liquid	Suction		CFM	No.	W (in.)	D (in.)	H (in.)			
TS010XR404A#†-T	A	ZF05KAE	3/8"	5/8"	8	1503	1	28.25	24.5	20.75	177	68	3.0 / 2.9
TS015XR404A#†-T	A	ZF06KAE	3/8"	5/8"	8	1503	1	28.25	24.5	20.75	178	68	3.1 / 3.1
TS020XR404A#†-T	B	ZF06K4E	1/2"	7/8"	15	2936	2	28.25	38.5	20.75	241	68	3.2 / 3.1
TS025XR404A#†-T	B	ZF08K4E	1/2"	7/8"	15	2936	2	28.25	38.5	20.75	246	68	3.2 / 3.2
TS030XR404A#†-T	B	ZF09K4E	1/2"	7/8"	15	2936	2	28.25	38.5	20.75	246	68	3.2 / 3.2
TS035XR404A#†-T	B	ZF11K4E	1/2"	7/8"	15	2936	2	28.25	38.5	20.75	250	74	3.2 / 3.2
TS045XR404A#†-T	C	ZF13K4E	1/2"	1-1/8"	18	3764	1	30.25	38.5	27.25	322	76	3.2 / 3.2
TS055XR404A#†-T	D	ZF15K4E	1/2"	1-1/8"	18	3809	1	30.25	42.4	29.75	346	76	3.2 / 3.2
TS060XR404A#†-T	D	ZF18K4E	1/2"	1-1/8"	18	3809	1	30.25	42.4	29.75	353	79	3.2 / 3.2
TS075XR404A#†-T	E	ZF25K4E	1/2"	1-1/8"	31	3839	1	38.1	46.4	38	481	80	3.2 / 3.2
TS100XR404A#†-T	E	ZF34K5E	1/2"	1-1/8"	31	3839	1	38.1	46.4	39.25	537	82	3.2 / 3.2

** : Sound pressure are measured 10 feet from the product.
 Note: # = Phase, 2 = 1Ph 208~230V 60Hz, 3 = 3Ph 208~230V 60Hz / †: Version (A, B, ~), T: Defrost timer

CONDENSING UNITS

R448A/449A

UNIT SPEC (LOW TEMP.) : SEMI-HERMETIC COMPRESSOR

Model	Fig. *	Copeland® Compressor	Connections (ID)		Receiver 90% Full (lbs)	Fan(s) Data		Dimensions			Net Weight (lbs)	Sound dBA**
			Liquid	Suction		CFM	No.	W (in.)	D (in.)	H (in.)		
TD040XR404A3	G	2DL3F20KE	1/2"	1-1/8"	18	3864	1	38.1	46.4	38	701	79
TD060XR404A3	G	3DA3F28KE	1/2"	1-1/8"	31	3849	1	38.1	46.4	38	793	79
TD075XR404A3	H	3DB3F33KE	1/2"	1-1/8"	31	3849	1	38.1	50.3	38.4	813	81
TD100XR404A3	I	3DS3F46KE	5/8"	1-3/8"	43	7557	2	38.1	58.2	39.25	941	82

** : Sound pressure are measured 10 feet from the product.
Note: 3 = 3Ph 208-230V 60Hz

ELECTRICAL DATA (MEDIUM TEMP.) : SCROLL COMPRESSORS

Model	Copeland® Compressor	Power Supply			Compressor		Fan Motor	MCA	MOPD
		Volts	Ph	Hz	RLA	LRA	FLA		
TS006MR404A2-T	ZB06KAE-PFV	208-230	1	60	6.0	35.7	0.47	15.0	15
TS008MR404A2-T	ZB08KAE-PFV	208-230	1	60	8.0	47.2	0.47	15.0	15
TS010MR404A2-T	ZS09KAE-PFV	208-230	1	60	10.0	40.3	0.47	15.0	20
TS015MR404A2A-T	ZS13KAE-PFV	208-230	1	60	12.0	56.0	0.94	15.9	25
TS015MR404A3A-T	ZS13KAE-TF5	208-230	3	60	9.7	58.0	0.94	15.0	20
TS020MR404A2A-T	ZS15KAE-PFV	208-230	1	60	15.7	68.0	0.94	20.6	30
TS020MR404A3A-T	ZS15KAE-TF5	208-230	3	60	10.6	58.0	0.94	15.0	20
TS025MR404A2A-T	ZS19KAE-PFV	208-230	1	60	18.0	75.0	0.94	23.4	40
TS025MR404A3A-T	ZS19KAE-TF5	208-230	3	60	13.7	73.0	0.94	18.1	30
TS030MR404A2-T	ZS21KAE-PFV	208-230	1	60	23.2	112.0	2.40	31.4	50
TS030MR404A3-T	ZS21KAE-TF5	208-230	3	60	15.2	93.0	2.40	21.4	30
TS040MR404A2-T	ZS29KAE-PFV	208-230	1	60	26.1	137.0	2.40	35.0	50
TS040MR404A3-T	ZS29KAE-TF5	208-230	3	60	20.5	114.0	2.40	28.0	40
TS050MR404A2A-T	ZS38K4E-PFV	208-230	1	60	31.8	169.0	2.40	42.2	70
TS050MR404A3A-T	ZS38K4E-TF5	208-230	3	60	21.4	123.0	2.40	29.2	50
TS060MR404A3-T	ZS45K4E-TF5	208-230	3	60	23.9	156.0	2.40	32.3	50
TS075MR404A3-T	ZB66K5E-TFC	208-230	3	60	39.3	225.0	4.80	53.9	70
TS100MR404A3-T	ZB95K5E-TWC	208-230	3	60	52.9	298.0	4.80	70.9	100

ELECTRICAL DATA (EXTRA LOW TEMP.) : SCROLL COMPRESSORS

Model	Copeland® Compressor	Power Supply			Compressor		Fan Motor	MCA *	MOPD *
		Volts	Ph	Hz	RLA	LRA	FLA		
TS010XR404A2	ZF05KAE-PFV	208-230	1	60	8.7	55.0	0.47	15.0	20
TS015XR404A2	ZF06KAE-PFV	208-230	1	60	13.6	68.0	0.47	17.5	30
TS015XR404A3	ZF06KAE-TF5	208-230	3	60	8.3	58.0	0.47	15.0	20
TS020XR404A2A	ZF06K4E-PFV	208-230	1	60	13.6	61.0	0.94	17.9	30
TS020XR404A3A	ZF06K4E-TF5	208-230	3	60	8.3	58.0	0.94	15.0	20
TS025XR404A2A	ZF08K4E-PFV	208-230	1	60	16.4	73.0	0.94	21.4	30
TS025XR404A3A	ZF08K4E-TF5	208-230	3	60	9.6	63.0	0.94	15.0	20
TS030XR404A2A	ZF09K4E-PFV	208-230	1	60	14.3	88.0	0.94	18.8	30
TS030XR404A3A	ZF09K4E-TF5	208-230	3	60	9.6	77.0	0.94	15.0	20
TS035XR404A2A	ZF11K4E-PFV	208-230	1	60	18.2	109.0	0.94	23.7	40
TS035XR404A3A	ZF11K4E-TF5	208-230	3	60	12.1	88.0	0.94	16.1	30
TS045XR404A2A	ZF13K4E-PFV	208-230	1	60	25.0	129.0	2.40	33.7	60
TS045XR404A3A	ZF13K4E-TF5	208-230	3	60	13.2	99.0	2.40	18.9	30
TS055XR404A2A	ZF15K4E-PFV	208-230	1	60	27.5	169.0	2.40	36.8	60
TS055XR404A3A	ZF15K4E-TF5	208-230	3	60	18.9	123.0	2.40	26.0	40
TS060XR404A3A	ZF18K4E-TF5	208-230	3	60	21.8	156.0	2.40	29.7	50
TS075XR404A3A	ZF25K4E-TF5	208-230	3	60	26.7	224.0	2.40	35.8	60
TS100XR404A3	ZF34K5E-TFC	208-230	3	60	37.1	239.0	2.40	48.8	80

CONDENSING UNITS

R448A/449A

ELECTRICAL DATA (LOW TEMP.) : SEMI-HERMETIC COMPRESSORS

Model	Copeland Compressor	Power Supply			Compressor		Fan Motor	MCA *	MOPD *
		Volts	Ph	Hz	RLA	LRA	FLA		
TD040XR404A3	2DL3F20KE	208-230	3	60	23.6	161	2.40	31.9	50
TD060XR404A3	3DA3F28KE	208-230	3	60	24.0	150	2.40	32.4	50
TD075XR404A3	3DB3F33KE	208-230	3	60	27.6	161	2.40	36.9	60
TD100XR404A3	3DS3F46KE	208-230	3	60	37.2	215	4.80	51.3	80

* : MCA Minimum Circuit Ampacity does not include evaporators electrical requirements (evaporator fan motor amps, defrost heater amps).

PERFORMANCE DATA (MEDIUM TEMP.) : SCROLL COMPRESSORS

Model	Copeland Compressor	Capacity BTU/HR @ 90°F. Ambient Suction Temperature °F							
		40°F	30°F	25°F	20°F	15°F	10°F	0°F	-10°F
TS006MR404A#†-T	ZB06KAE	9606	7968	7254	6576	5924	5314	4209	3322
TS008MR404A#†-T	ZB08KAE	12880	10745	9851	8850	8012	7177	5762	4620
TS010MR404A#†-T	ZS09KAE	13740	11230	10250	9175	8326	7508	6115	4888
TS015MR404A#†-T	ZS13KAE	19640	16044	14443	12905	11600	10522	8476	-
TS020MR404A#†-T	ZS15KAE	23100	18980	17090	15273	13770	12558	10140	-
TS025MR404A#†-T	ZS19KAE	25500	20842	18943	16985	15375	14080	11395	-
TS030MR404A#†-T	ZS21KAE	35715	30025	27478	24865	22400	20385	16180	-
TS040MR404A#†-T	ZS29KAE	45990	38953	35398	32030	28880	26285	20870	-
TS050MR404A#†-T	ZS38K4E	56710	48317	44187	40113	36627	32813	26533	21240
TS060MR404A#†-T	ZS45K4E	67227	57210	52327	48120	43840	39400	31280	24267
TS075MR404A#†-T	ZB66K5E	100333	84300	76900	69250	62850	56450	44170	32820
TS100MR404A#†-T	ZB95K5E	133600	112600	101167	92567	83750	74400	57500	42620

Model	Copeland Compressor	Capacity BTU/HR @ 95°F. Ambient Suction Temperature °F							
		40°F	30°F	25°F	20°F	15°F	10°F	0°F	-10°F
TS006MR404A#†-T	ZB06KAE	9198	7686	6998	6300	5672	5086	4054	3204
TS008MR404A#†-T	ZB08KAE	12343	10320	9404	8530	7732	6932	5577	4440
TS010MR404A#†-T	ZS09KAE	13175	10830	9888	8850	8052	7280	5945	4804
TS015MR404A#†-T	ZS13KAE	19021	15532	13981	12493	11180	10218	8266	-
TS020MR404A#†-T	ZS15KAE	22298	18245	16540	14688	13345	12189	9825	-
TS025MR404A#†-T	ZS19KAE	24270	20117	18163	16295	14863	13630	11058	-
TS030MR404A#†-T	ZS21KAE	34390	28933	26470	23940	21720	19740	15455	-
TS040MR404A#†-T	ZS29KAE	44700	37587	34140	30880	27805	25273	19958	-
TS050MR404A#†-T	ZS38K4E	54810	46650	42347	38680	35360	31933	25513	20640
TS060MR404A#†-T	ZS45K4E	64490	54827	50513	46020	41560	37360	29920	23200
TS075MR404A#†-T	ZB66K5E	96167	80067	73100	66500	60100	53700	41830	30680
TS100MR404A#†-T	ZB95K5E	128600	106200	96333	86767	78350	69667	54250	39720

CONDENSING UNITS

R448A/449A

PERFORMANCE DATA (MEDIUM TEMP.) : SCROLL COMPRESSORS

Model	Copeland Compressor	Capacity BTU/HR @ 100°F. Ambient Suction Temperature °F							
		40°F	30°F	25°F	20°F	15°F	10°F	0°F	-10°F
TS006MR404A#†-T	ZB06KAE	8855	7401	6738	6065	5458	4893	3898	3060
TS008MR404A#†-T	ZB08KAE	11805	9907	9108	8210	7396	6687	5350	4287
TS010MR404A#†-T	ZS09KAE	12550	10334	9480	8590	7767	7030	5770	4698
TS015MR404A#†-T	ZS13KAE	18315	14917	13518	12080	10900	9915	8014	-
TS020MR404A#†-T	ZS15KAE	21285	17485	15942	14298	12920	11746	9615	-
TS025MR404A#†-T	ZS19KAE	23170	19183	17513	15630	14350	13090	10653	-
TS030MR404A#†-T	ZS21KAE	33040	27750	25397	22900	20700	18773	14875	-
TS040MR404A#†-T	ZS29KAE	42600	35837	32843	29500	26730	24260	19045	-
TS050MR404A#†-T	ZS38K4E	52790	44650	40813	37247	33800	30533	24580	-
TS060MR404A#†-T	ZS45K4E	61640	52880	48250	43920	40040	35660	28480	-
TS075MR404A#†-T	ZB66K5E	92000	77133	69600	63167	57170	50393	39430	28380
TS100MR404A#†-T	ZB95K5E	120200	100600	91500	81933	73850	65500	-	-

Model	Copeland Compressor	Capacity BTU/HR @ 110°F. Ambient Suction Temperature °F							
		40°F	30°F	25°F	20°F	15°F	10°F	0°F	-10°F
TS006MR404A#†-T	ZB06KAE	8311	6888	6268	5638	5068	4540	3610	2817
TS008MR404A#†-T	ZB08KAE	10949	9256	8528	7698	6941	6246	5008	-
TS010MR404A#†-T	ZS09KAE	11525	9436	8720	7816	7086	6440	5355	-
TS015MR404A#†-T	ZS13KAE	16763	13783	12435	11175	10126	9264	7568	-
TS020MR404A#†-T	ZS15KAE	19445	16055	14675	13040	11840	10945	9024	-
TS025MR404A#†-T	ZS19KAE	20955	17490	16063	14350	13000	12038	9905	-
TS030MR404A#†-T	ZS21KAE	30700	25772	23583	21100	19140	17120	13430	-
TS040MR404A#†-T	ZS29KAE	39680	33333	30523	27340	24800	22225	17490	-
TS050MR404A#†-T	ZS38K4E	49400	41730	38160	34550	31360	28380	22900	-
TS060MR404A#†-T	ZS45K4E	-	49007	44650	40380	36920	33220	-	-
TS075MR404A#†-T	ZB66K5E	84100	71250	64000	57167	51070	45413	-	-
TS100MR404A#†-T	ZB95K5E	-	-	81900	73700	66150	58500	-	-

Note: # = Phase, 2 = 1Ph 208-230V 60Hz, 3 = 3Ph 208-230V 60Hz / †: Version (A, B, ~) / T: Defrost timer

PERFORMANCE DATA (EXTRA LOW TEMP.) : SCROLL COMPRESSORS

Model	Copeland Compressor	Capacity BTU/HR @ 90°F. Ambient Suction Temperature °F							
		0°F	-10°F	-15°F	-20°F	-25°F	-30°F	-35°F	-40°F
TS010XR404A#†-T	ZF05KAE	7269	5747	5106	4461	3928	3406	2967	2600
TS015XR404A#†-T	ZF06KAE	9330	7492	6655	5936	5277	4640	4063	3540
TS020XR404A#†-T	ZF06K4E	11050	8815	7842	6951	6120	5407	4772	4198
TS025XR404A#†-T	ZF08K4E	12880	10690	9670	8702	7773	6850	5930	5016
TS030XR404A#†-T	ZF09K4E	14125	11540	10353	9290	8271	7332	6411	5499
TS035XR404A#†-T	ZF11K4E	17365	14060	12630	11255	10042	8920	7882	6955
TS045XR404A#†-T	ZF13K4E	22460	17980	15840	14000	12233	10740	9300	8054
TS055XR404A#†-T	ZF15K4E	26800	21380	18980	16777	14710	12990	11310	9880
TS060XR404A#†-T	ZF18K4E	32180	26100	23247	20527	18220	15960	14040	12187
TS075XR404A#†-T	ZF25K4E	40560	32280	28887	25433	22420	19753	17247	15113
TS100XR404A#†-T	ZF34K5E	50620	41120	36580	32590	28873	25207	21880	18727

Model	Copeland Compressor	Capacity BTU/HR @ 95°F. Ambient Suction Temperature °F							
		0°F	-10°F	-15°F	-20°F	-25°F	-30°F	-35°F	-40°F
TS010XR404A#†-T	ZF05KAE	6998	5532	4885	4270	3766	3268	2871	2503
TS015XR404A#†-T	ZF06KAE	8972	7172	6430	5746	5079	4472	3920	3416
TS020XR404A#†-T	ZF06K4E	10525	8492	7567	6720	5960	5280	4662	4108
TS025XR404A#†-T	ZF08K4E	12480	10330	9370	8445	7544	6648	5777	4840
TS030XR404A#†-T	ZF09K4E	13750	11210	10118	9032	8050	7145	6242	5366
TS035XR404A#†-T	ZF11K4E	16757	13603	12150	10930	9694	8602	7610	6716
TS045XR404A#†-T	ZF13K4E	21450	17180	15260	13490	11800	10373	9033	7867
TS055XR404A#†-T	ZF15K4E	25720	20540	18240	16245	14260	12623	11010	9647
TS060XR404A#†-T	ZF18K4E	30980	24960	22300	19880	17600	15460	13680	11970
TS075XR404A#†-T	ZF25K4E	39160	31180	27700	24460	21610	19200	16840	14870
TS100XR404A#†-T	ZF34K5E	48760	39770	35380	31540	27800	24300	21110	18200

CONDENSING UNITS

R448A/449A

PERFORMANCE DATA (EXTRA LOW TEMP.) : SCROLL COMPRESSORS

Model		Capacity BTU/HR @ 100°F. Ambient Suction Temperature °F							
		0°F	-10°F	-15°F	-20°F	-25°F	-30°F	-35°F	-40°F
TS010XR404A#†-T	ZF05KAE	6663	5273	4700	4110	3626	3148	2776	2418
TS015XR404A#†-T	ZF06KAE	8612	6902	6200	5513	4880	4303	3800	3290
TS020XR404A#†-T	ZF06K4E	10217	8207	7312	6450	5760	5070	4490	3986
TS025XR404A#†-T	ZF08K4E	12093	10035	9119	8230	7349	6478	5612	4648
TS030XR404A#†-T	ZF09K4E	13317	10900	9810	8805	7860	6970	6072	5196
TS035XR404A#†-T	ZF11K4E	15770	13023	11733	10496	9389	8333	7380	6511
TS045XR404A#†-T	ZF13K4E	20413	16480	14660	12940	11320	9928	8760	7734
TS055XR404A#†-T	ZF15K4E	24813	19840	17640	15720	13810	12130	10675	9444
TS060XR404A#†-T	ZF18K4E	29460	23827	21340	19100	17000	15060	13320	11790
TS075XR404A#†-T	ZF25K4E	37427	29860	26700	23660	20960	18600	16540	14720
TS100XR404A#†-T	ZF34K5E	46860	38000	33860	30247	26900	23550	20590	17700

Model		Capacity BTU/HR @ 110°F. Ambient Suction Temperature °F							
		0°F	-10°F	-15°F	-20°F	-25°F	-30°F	-35°F	-40°F
TS010XR404A#†-T	ZF05KAE	6215	4883	4358	3810	3369	2932	2576	2263
TS015XR404A#†-T	ZF06KAE	7888	6470	5786	5159	4547	4045	3560	3104
TS020XR404A#†-T	ZF06K4E	9467	7590	6762	5954	5284	4693	4123	3673
TS025XR404A#†-T	ZF08K4E	11327	9519	8657	7822	6950	6149	5272	4347
TS030XR404A#†-T	ZF09K4E	12537	10300	9270	8307	7392	6505	5629	4813
TS035XR404A#†-T	ZF11K4E	14880	12250	10983	9812	8736	7767	6930	6123
TS045XR404A#†-T	ZF13K4E	18920	15173	13413	11900	10536	9348	8380	7558
TS055XR404A#†-T	ZF15K4E	23133	18580	16583	14720	13067	11610	10237	9106
TS060XR404A#†-T	ZF18K4E	27120	22147	19900	17900	16100	14387	12873	11540
TS075XR404A#†-T	ZF25K4E	35373	28100	25080	22380	19953	17900	16100	14667
TS100XR404A#†-T	ZF34K5E	43790	35300	31520	28207	25160	22120	19360	16833

Note: # = Phase, 2 = 1Ph 208~230V 60Hz, 3 = 3Ph 208~230V 60Hz / †: Version (A, B, ~) / T: Defrost timer

CONDENSING UNITS

R448A/449A

PERFORMANCE DATA (LOW TEMP.) : SEMI-HERMETIC COMPRESSORS

Model		Capacity BTU/HR @ 90°F. Ambient Suction Temperature °F							
		0°F	-10°F	-15°F	-20°F	-25°F	-30°F	-35°F	-40°F
TD040XR404A3	2DL3F20KE	30460	24156	20996	18110	15654	13250	11143	9181
TD060XR404A3	3DA3F28KE	44532	35004	30480	26484	22892	19772	16992	14142
TD075XR404A3	3DB3F33KE	56076	43892	38764	33728	29524	25632	21648	18064
TD100XR404A3	3DS3F46KE	75992	58752	51416	44800	38808	32964	27588	23028

Model		Capacity BTU/HR @ 95°F. Ambient Suction Temperature °F							
		0°F	-10°F	-15°F	-20°F	-25°F	-30°F	-35°F	-40°F
TD040XR404A3	2DL3F20KE	29148	22540	19812	17262	14714	12450	10434	8575
TD060XR404A3	3DA3F28KE	41796	33132	28800	24924	21164	18130	15492	12952
TD075XR404A3	3DB3F33KE	53636	41732	36724	31768	27656	23880	19968	16480
TD100XR404A3	3DS3F46KE	71656	56384	49208	42200	36416	30676	25404	20900

Model		Capacity BTU/HR @ 100°F. Ambient Suction Temperature °F							
		0°F	-10°F	-15°F	-20°F	-25°F	-30°F	-35°F	-40°F
TD040XR404A3	2DL3F20KE	27444	21452	18592	16186	13782	11650	9738	8003
TD060XR404A3	3DA3F28KE	39948	31212	27040	23316	19992	17026	14212	11976
TD075XR404A3	3DB3F33KE	51196	39572	34668	30200	26152	22080	18208	14480
TD100XR404A3	3DS3F46KE	67976	52704	45848	39600	33976	28788	23124	18662

Model		Capacity BTU/HR @ 110°F. Ambient Suction Temperature °F							
		0°F	-10°F	-15°F	-20°F	-25°F	-30°F	-35°F	-40°F
TD040XR404A3	2DL3F20KE	24580	19168	16844	14446	12310	10370	8682	7160
TD060XR404A3	3DA3F28KE	36660	28080	24188	20680	17528	14734	12044	9692
TD075XR404A3	3DB3F33KE	47404	36140	31340	26672	22768	19200	15408	11775
TD100XR404A3	3DS3F46KE	62016	47696	41240	35248	29360	24420	19348	14988

CONDENSING UNITS

R404A

MODEL NOMENCLATURE

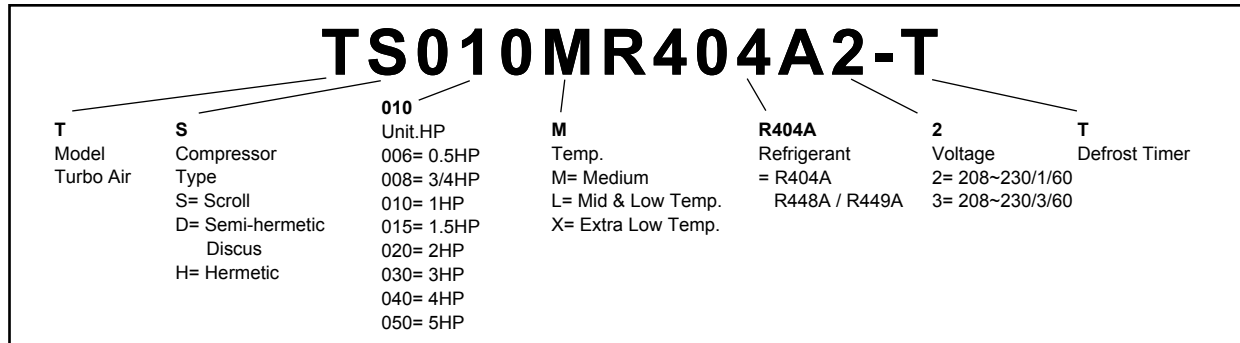

PERFORMANCE DATA (MEDIUM TEMP.) : SCROLL COMPRESSORS

Model	 Compressor	Capacity BTU/HR @ 90°F. Ambient Suction Temperature °F.							
		40°F	30°F	25°F	20°F	15°F	10°F	0°F	-10°F
TS006MR404A#†-T	ZB06KAE	9877	8229	7476	6760	6090	5512	4394	3530
TS008MR404A#†-T	ZB08KAE	13215	10835	9911	9010	8250	7490	6142	4814
TS010MR404A#†-T	ZS09KAE	13880	11900	11060	10113	9266	8472	6913	5447
TS015MR404A#†-T	ZS13KAE	17808	16790	15358	13890	12658	11503	9372	7510
TS020MR404A#†-T	ZS15KAE	23373	20100	18650	17075	15625	14260	11625	9111
TS025MR404A#†-T	ZS19KAE	25487	21910	20300	18600	17210	15600	12785	10107
TS030MR404A#†-T	ZS21KAE	34920	29900	27520	25420	23275	21260	17328	13543
TS040MR404A#†-T	ZS29KAE	44500	38140	35020	32100	29635	26840	22027	17290
TS050MR404A#†-T	ZS38K4E	54650	46920	43690	39910	36650	33600	27760	22800
TS060MR404A#†-T	ZS45K4E	63850	54600	50820	46860	43055	39530	33160	27280
TS075MR404A#†-T	ZB66K5E	101340	86860	80440	73700	68180	61820	50880	41020
TS100MR404A#†-T	ZB95K5E	131633	113100	104920	97127	89867	82300	67520	53320

Model	 Compressor	Capacity BTU/HR @ 95°F. Ambient Suction Temperature °F.							
		40°F	30°F	25°F	20°F	15°F	10°F	0°F	-10°F
TS006MR404A#†-T	ZB06KAE	9400	7862	7154	6480	5840	5248	4214	3360
TS008MR404A#†-T	ZB08KAE	12543	10310	9377	8615	7903	7188	5860	4586
TS010MR404A#†-T	ZS09KAE	13320	11383	10495	9691	8876	8112	6673	5182
TS015MR404A#†-T	ZS13KAE	16933	15965	14620	13240	12070	10980	8894	7207
TS020MR404A#†-T	ZS15KAE	22467	19190	17657	16300	14938	13660	11133	8665
TS025MR404A#†-T	ZS19KAE	24220	20960	19447	17840	16480	15080	12248	9616
TS030MR404A#†-T	ZS21KAE	33220	28587	26340	24127	22250	20360	16590	12900
TS040MR404A#†-T	ZS29KAE	42367	36373	33427	30700	28105	25690	20925	16270
TS050MR404A#†-T	ZS38K4E	51900	44570	41540	37960	34875	32040	26540	21800
TS060MR404A#†-T	ZS45K4E	60600	52360	48800	44560	40980	37680	31700	26160
TS075MR404A#†-T	ZB66K5E	95940	82427	76487	70167	64400	59020	48530	38740
TS100MR404A#†-T	ZB95K5E	123850	106600	99020	91660	84783	77600	-	-

Note: # = Phase, 2 = 1Ph 208~230V 60Hz, 3 = 3Ph 208~230V 60Hz / †: Version (A, B, ~) / T: Defrost timer

CONDENSING UNITS

R404A

PERFORMANCE DATA (MEDIUM TEMP.) : SCROLL COMPRESSORS

Model	Copeland Compressor	Capacity BTU/HR @ 100°F. Ambient Suction Temperature °F.							
		40°F	30°F	25°F	20°F	15°F	10°F	0°F	-10°F
TS006MR404A#†-T	ZB06KAE	8830	7418	6758	6190	5582	5066	4029	3190
TS008MR404A#†-T	ZB08KAE	12013	9896	9019	8220	7558	6883	5630	4399
TS010MR404A#†-T	ZS09KAE	12620	10867	10052	9317	8554	7770	6387	4922
TS015MR404A#†-T	ZS13KAE	16011	15107	13850	12563	11471	10350	8484	6892
TS020MR404A#†-T	ZS15KAE	21107	18340	17070	15683	14380	13040	10640	8240
TS025MR404A#†-T	ZS19KAE	23207	20010	18630	17293	15880	14537	-	-
TS030MR404A#†-T	ZS21KAE	31520	27320	25240	23193	21450	19467	-	-
TS040MR404A#†-T	ZS29KAE	40233	34807	32060	29533	27050	24667	20025	15470
TS050MR404A#†-T	ZS38KAE	49150	42180	39370	36000	33100	30440	25240	20800
TS060MR404A#†-T	ZS45K4E	57300	49510	45650	42180	39280	35810	29900	24960
TS075MR404A#†-T	ZB66K5E	90540	77960	72453	67233	61050	55473	-	-
TS100MR404A#†-T	ZB95K5E	115600	99830	93010	86193	79700	72900	-	-

Model	Copeland Compressor	Capacity BTU/HR @ 110°F. Ambient Suction Temperature °F.							
		40°F	30°F	25°F	20°F	15°F	10°F	0°F	-10°F
TS006MR404A#†-T	ZB06KAE	8062	6814	6225	5656	5108	4592	3660	2839
TS008MR404A#†-T	ZB08KAE	10802	8976	8291	7500	6937	6340	5216	-
TS010MR404A#†-T	ZS09KAE	11570	10131	9343	8674	8039	7338	5925	-
TS015MR404A#†-T	ZS13KAE	14536	13547	12425	11273	10442	9438	7681	6283
TS020MR404A#†-T	ZS15KAE	19500	17030	15655	14573	13435	12260	-	-
TS025MR404A#†-T	ZS19KAE	21300	18550	17320	16030	14800	13503	-	-
TS030MR404A#†-T	ZS21KAE	29100	25260	23550	21700	20010	18267	-	-
TS040MR404A#†-T	ZS29KAE	37080	32070	29600	27433	25250	23167	-	-
TS050MR404A#†-T	ZS38K4E	44550	38300	35385	32800	30180	27490	22850	18940
TS060MR404A#†-T	ZS45K4E	-	44800	41370	38320	35350	32690	27360	22800
TS075MR404A#†-T	ZB66K5E	82820	71670	65150	60633	55690	50620	-	-
TS100MR404A#†-T	ZB95K5E	-	-	-	76700	71050	64040	-	-

Note: # = Phase, 2 = 1Ph 208~230V 60Hz, 3 = 3Ph 208~230V 60Hz / †: Version (A, B, ~) / T: Defrost timer

PERFORMANCE DATA (LOW TEMP.) : SCROLL COMPRESSORS

Model	Copeland Compressor	Capacity BTU/HR @ 90°F. Ambient Suction Temperature °F.							
		0°F	-10°F	-15°F	-20°F	-25°F	-30°F	-35°F	-40°F
TS010XR404A#†-T	ZF05KAE	7644	6112	5457	4894	4327	3822	3367	2951
TS015XR404A#†-T	ZF06KAE	9660	7864	7134	6370	5718	5114	4510	3964
TS020XR404A#†-T	ZF06K4E	11500	9473	8561	7704	6846	6094	5380	4702
TS025XR404A#†-T	ZF08K4E	14150	11600	10609	9530	8533	7612	6760	5961
TS030XR404A#†-T	ZF09K4E	15560	12870	11700	10513	9511	8432	7479	6592
TS035XR404A#†-T	ZF11K4E	18700	15380	14020	12650	11430	10316	9160	8086
TS045XR404A#†-T	ZF13K4E	23500	19153	17320	15380	13653	12000	10567	9244
TS055XR404A#†-T	ZF15K4E	28640	23487	21147	19040	17033	15053	13400	11820
TS060XR404A#†-T	ZF18K4E	33130	27270	24700	22260	20120	17780	15827	13867
TS075XR404A#†-T	ZF25K4E	41820	34110	30940	27727	24760	22040	19567	17310
TS100XR404A#†-T	ZF34K5E	52000	42960	38800	35200	31740	28200	24887	21820

Model	Copeland Compressor	Capacity BTU/HR @ 95°F. Ambient Suction Temperature °F.							
		0°F	-10°F	-15°F	-20°F	-25°F	-30°F	-35°F	-40°F
TS010XR404A#†-T	ZF05KAE	7274	5817	5192	4615	4127	3648	3219	2823
TS015XR404A#†-T	ZF06KAE	9127	7452	6777	6060	5448	4838	4270	3794
TS020XR404A#†-T	ZF06K4E	11000	9092	8158	7350	6586	5864	5170	4509
TS025XR404A#†-T	ZF08K4E	13500	11100	10063	9056	8120	7314	6445	5682
TS030XR404A#†-T	ZF09K4E	14847	12320	11200	10078	9060	8035	7134	6294
TS035XR404A#†-T	ZF11K4E	17540	14640	13367	12100	10980	9812	8728	7710
TS045XR404A#†-T	ZF13K4E	22500	18360	16450	14740	13080	11500	10100	8824
TS055XR404A#†-T	ZF15K4E	27340	22460	20260	18120	16220	14480	12900	11387
TS060XR404A#†-T	ZF18K4E	31680	26120	23700	21380	19220	17140	15280	13400
TS075XR404A#†-T	ZF25K4E	40020	32660	29450	26420	23630	21245	18900	16760
TS100XR404A#†-T	ZF34K5E	48947	40980	37440	33700	30440	27050	23860	20760

CONDENSING UNITS

R404A

PERFORMANCE DATA (LOW TEMP.) : SCROLL COMPRESSORS

Model	Copeland Compressor	Capacity BTU/HR @ 100°F. Ambient Suction Temperature °F.							
		0°F	-10°F	-15°F	-20°F	-25°F	-30°F	-35°F	-40°F
TS010XR404A#†-T	ZF05KAE	6820	5458	4926	4380	3881	3432	3033	2688
TS015XR404A#†-T	ZF06KAE	8593	7039	6414	5747	5127	4608	4071	3590
TS020XR404A#†-T	ZF06K4E	10503	8630	7818	7050	6326	5634	4924	4285
TS025XR404A#†-T	ZF08K4E	12833	10578	9595	8653	7770	6942	6170	5388
TS030XR404A#†-T	ZF09K4E	14080	11620	10578	9542	8680	7700	6839	6034
TS035XR404A#†-T	ZF11K4E	16573	13873	12700	11500	10365	9371	8357	7390
TS045XR404A#†-T	ZF13K4E	21260	17560	15700	14090	12480	11000	9655	8360
TS055XR404A#†-T	ZF15K4E	25753	21200	19360	17320	15520	13880	12240	10850
TS060XR404A#†-T	ZF18K4E	29847	24720	22700	20480	18420	16490	14680	12860
TS075XR404A#†-T	ZF25K4E	37860	30927	28200	25320	22680	20315	18120	16150
TS100XR404A#†-T	ZF34K5E	46380	38880	35233	32100	28800	25640	22600	19860

Model	Copeland Compressor	Capacity BTU/HR @ 110°F. Ambient Suction Temperature °F.							
		0°F	-10°F	-15°F	-20°F	-25°F	-30°F	-35°F	-40°F
TS010XR404A#†-T	ZF05KAE	6136	4912	4440	3948	3499	3099	2744	2437
TS015XR404A#†-T	ZF06KAE	-	-	5760	5183	4647	4148	3685	3296
TS020XR404A#†-T	ZF06K4E	9633	8033	7297	6543	5882	5247	4587	3980
TS025XR404A#†-T	ZF08K4E	11633	9612	8719	7873	7080	6336	5635	4966
TS030XR404A#†-T	ZF09K4E	12853	10540	9612	8696	7930	7040	6263	5524
TS035XR404A#†-T	ZF11K4E	14960	12800	11633	10420	9387	8424	7523	6736
TS045XR404A#†-T	ZF13K4E	19500	16013	14373	12900	11467	10130	8911	7745
TS055XR404A#†-T	ZF15K4E	23567	19493	17647	15787	14180	12733	11233	9981
TS060XR404A#†-T	ZF18K4E	27340	22800	20780	18807	16980	15120	13480	11967
TS075XR404A#†-T	ZF25K4E	34620	28633	25920	23393	21040	18970	17050	15330
TS100XR404A#†-T	ZF34K5E	42160	35520	32247	29100	26100	23300	20500	18053

Note: # : Phase, 2 = 1Ph 208-230V 60Hz, 3 = 3Ph 208-230V 60Hz / † : Version (A, B, ~) / T : Defrost timer

PERFORMANCE DATA (LOW TEMP.) : SEMI-HERMETIC COMPRESSORS

Model	Copeland Compressor	Capacity BTU/HR @ 90°F. Ambient Suction Temperature °F.							
		0°F	-10°F	-15°F	-20°F	-25°F	-30°F	-35°F	-40°F
TD040XR404A3	2DL3F20KE	32207	26447	23700	21280	18700	16320	14160	12080
TD060XR404A3	3DA3F28KE	46100	38100	33820	30180	26670	23450	20500	17810
TD075XR404A3	3DB3F33KE	57500	46460	41690	37220	33050	28880	25260	21640
TD100XR404A3	3DS3F46KE	77500	63900	57500	50900	45500	40260	35340	30500

Model	Copeland Compressor	Capacity BTU/HR @ 95°F. Ambient Suction Temperature °F.							
		0°F	-10°F	-15°F	-20°F	-25°F	-30°F	-35°F	-40°F
TD040XR404A3	2DL3F20KE	29727	24813	22200	19967	17600	15300	13200	11180
TD060XR404A3	3DA3F28KE	43600	35633	31980	28547	25280	22180	19300	16660
TD075XR404A3	3DB3F33KE	54707	44700	40100	35480	31180	27480	23640	20340
TD100XR404A3	3DS3F46KE	73667	60867	55000	48740	43480	38100	33360	29000

Model	Copeland Compressor	Capacity BTU/HR @ 100°F. Ambient Suction Temperature °F.							
		0°F	-10°F	-15°F	-20°F	-25°F	-30°F	-35°F	-40°F
TD040XR404A3	2DL3F20KE	-	23180	21000	18633	16400	14260	12204	10280
TD060XR404A3	3DA3F28KE	41100	33980	30487	27133	24000	21073	18000	15420
TD075XR404A3	3DB3F33KE	51840	42060	37753	33693	29573	26000	22580	19040
TD100XR404A3	3DS3F46KE	70600	58333	52153	46280	41300	36100	31620	27440

Model	Copeland Compressor	Capacity BTU/HR @ 110°F. Ambient Suction Temperature °F.							
		0°F	-10°F	-15°F	-20°F	-25°F	-30°F	-35°F	-40°F
TD040XR404A3	2DL3F20KE	-	-	-	16767	14480	12553	10636	8845
TD060XR404A3	3DA3F28KE	-	-	27500	24307	21333	18460	15807	12980
TD075XR404A3	3DB3F33KE	-	38540	34660	30513	26960	23553	20267	16773
TD100XR404A3	3DS3F46KE	-	52633	46873	41960	37300	32787	28140	23733

Note: 2=1Ph 208-230V 60Hz, 3=3Ph 208-230V 60Hz

PACKAGE UNIT STANDARD FEATURES

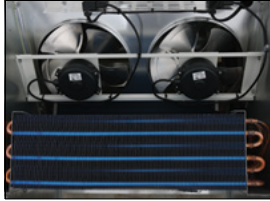

■ **SM 1: Blue Anti-corrosion-fin and Coated Copper Tube**

Protects aluminum and copper pipes from toxic gases generated from foods, retards refrigerant leakage, and prolongs the cooling capacity.



■ **SM 2: Expansion Valve & Solenoid Valve**

Allows safe storage of foods with a feature that self-adjusts the circulation of refrigerant as the internal temperature changes, thus recovering the required temperature quickly. And protects compressor from preventing liquid refrigerant flood back to compressor.



■ **SM 3: Hot Gas Defrost**

Reduced Defrost time improve temperature fluctuation of the cold storage helps maintain product quality and efficiency of system.

■ **SM 4: Efficient Micro Channel Condenser Coil**

Higher efficiency from larger heat transfer area compare to fin and tube condenser coil. Compact and lighter structure reduces weight of the unit. Improved durability and corrosion resistance than traditional copper-aluminum coils.



■ **SM 5: Energy Efficient EC Motor**

Through the use of highly efficient EC motors, our products reduce energy consumption and lower electricity costs, thus protecting the environment. Our products are designed with easy-to-replace motor and fan blades.

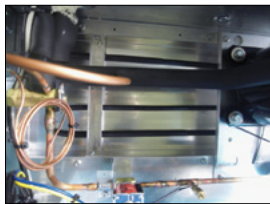

■ **SM 6: Leak Free Patented Hot Gas Condensate System**

The hot gas condensate system is an ideal system because of its fast evaporation of condensed water and its enhancing refrigeration efficiency. In spite of these advantages, many companies have stopped the application of such a system because of the high risk of discarding the refrigerators due to the rapid corrosion of hot gas lines causing refrigerant leakage and water inflow into the cooling pipes. Such problems are completely resolved in our products, thanks to a patented technology that prevents pipes from corrosion.



■ **SM 7: Highly Efficient Air Circulation Enclosure**

This system is designed to release hot air to the outside faster than competitors' and to enhance cooling efficiency. At the same time, it retards elevation of compressor temperature and keeps refrigerant pressure from increasing, thus saving energy as a result.



All Replacement Parts are Universal!

DIMENSIONAL DATA

(unit : inch)

Figure A. Panel Opening Size: 25" x 25"

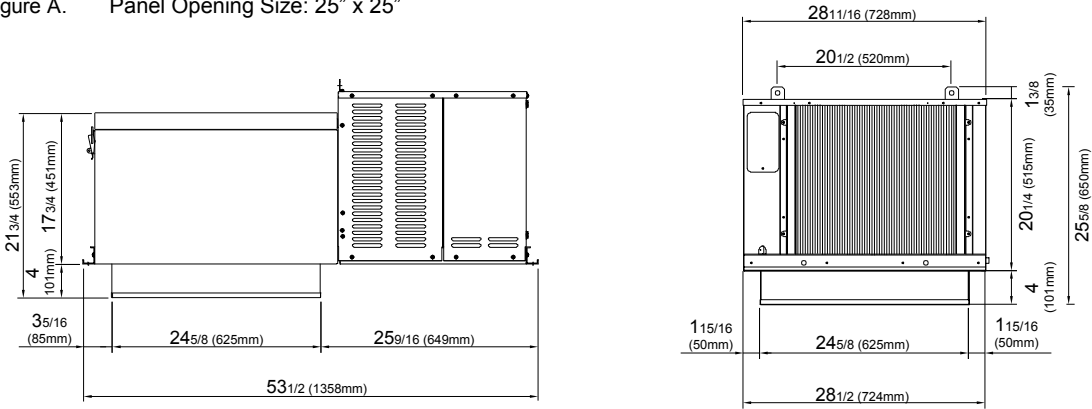
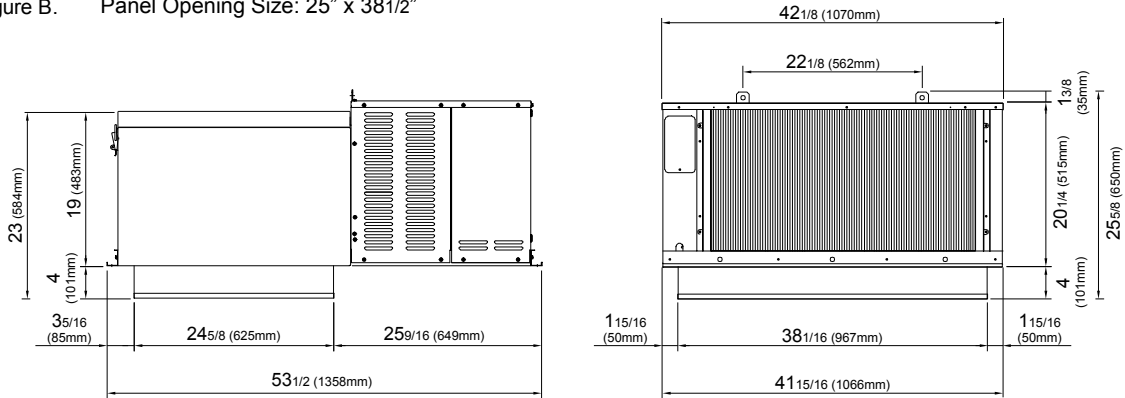

Figure B. Panel Opening Size: 25" x 38 1/2"



Note : Outdoor models are provided with a top hood.

PACKAGE REFRIGERATION UNITS

MODEL NOMENCLATURE

S	T	I	055	M	P	2
Model		Location	Capacity	Temp.	Refrigerant	Voltage
Turbo air Top Mount Package Unit		I= Indoor X= Outdoor	*= BTUH x 100	M= Medium Temp. L= Low Temp.	P=R290 (Propane)	2= 208-230V 1PH 60Hz 3= 208-230V 3PH 60Hz

TOP MOUNT PACKAGE UNIT

Performance Data - Medium Temperature Models, Air Defrost (R-290)

Model	embraco Compressor	Capacity BTU / HR (Ambient Temp)														
		80°F			90°F			95°F			100°F			110°F		
		Room Temperature °F														
		34°F	35°F	38°F	34°F	35°F	38°F	34°F	35°F	38°F	34°F	35°F	38°F	34°F	35°F	38°F
ST*055MP2	NEU6217U	6041	6178	6449	5659	5788	6039	5425	5549	5829	5266	5386	5616	4899	5011	5266
ST*078MP2	NTX6225UV	8598	8799	9254	8005	8194	8625	7676	7859	8276	7415	7593	7928	6829	6996	7374
ST*110MP2	NEU6217U	12005	12278	12816	11242	11497	11996	10771	11016	11573	10453	10691	11147	9715	9938	10443
ST*155MP2	NTX6225UV	17064	17463	18368	15878	16254	17110	15221	15585	16312	14699	15053	15718	13529	13859	14609

Performance Data - Low Temperature Models, Hot Gas Defrost (R-290)

Model	embraco Compressor	Capacity BTU / HR (Ambient Temp)														
		80°F			90°F			95°F			100°F			110°F		
		Room Temperature °F														
		0°F	-10°F	-20°F	0°F	-10°F	-20°F	0°F	-10°F	-20°F	0°F	-10°F	-20°F	0°F	-10°F	-20°F
ST*025LP2	NT2180UV	3708	2852	2147	3362	2618	1976	3282	2539	1919	3139	2435	1843	2876	2235	-
ST*038LP2	NTX2211UV	5476	4330	3347	5026	3965	3055	4801	3782	2909	4576	3599	2735	4171	3272	-
ST*050LP2	NT2180UV	7363	5666	4266	6670	5196	3924	6507	5039	3809	6222	4826	3652	5692	4423	-
ST*075LP2	NTX2211UV	10861	8587	6635	9963	7856	6051	9512	7491	5759	9062	7126	5412	8253	6472	-

PACKAGE REFRIGERATION UNITS

UNIT SPECIFICATIONS - MEDIUM TEMPERATURE MODELS, Air Defrost (R-290)

Model	Power Supply			MCA	MOPD	Unit Amps	Evaporator fan Qty/CFM	Plug Supplied	Matching NEMA Receptacle	Dim. Fig.	Sound dBA **	Net Weight lbs (kg)	AWEF
	Voltage	PH	Hz										
ST*055MP2	208-230	1	60	7.9	15	6.6	982	† YES	6-15R	A		219 (99) / 233 (106)	5.61 / 7.6
ST*078MP2	208-230	1	60	10.0	15	8.3	982	† YES	6-15R	A		218 (99) / 231 (105)	5.61 / 7.6
ST*110MP2	208-230	1	60	13.9	20	12.6	1625	† YES	6-20R	B		300 (136) / 317 (144)	5.61 / 7.6
ST*155MP2	208-230	1	60	17.7	25	16.0	1625	NO	-	B		300 (136) / 317 (144)	5.61 / 7.6

UNIT SPECIFICATIONS - LOW TEMPERATURE MODELS, Hot Gas Defrost (R-290)

Model	Power Supply			MCA	MOPD	Unit Amps	Evaporator fan Qty/CFM	Plug Supplied	Matching NEMA Receptacle	Dim. Fig.	Sound dBA **	Net Weight lbs (kg)	AWEF
	Voltage	PH	Hz										
ST*025LP2	208-230	1	60	7.6	15	6.4	1033	† YES	6-15R	A		216 (98) / 230 (104)	2.01 / 2.00
ST*038LP2	208-230	1	60	9.1	15	7.6	1033	† YES	6-15R	A		216 (98) / 230 (104)	2.21 / 2.10
ST*050LP2	208-230	1	60	13.4	20	12.2	1647	† YES	6-20R	B		288 (131) / 305 (138)	2.21 / 2.20
ST*075LP2	208-230	1	60	16.1	25	14.6	1647	NO	-	B		288 (131) / 305 (138)	2.40 / 3.15

* : I For Indoor Unit, X For Outdoor Unit. †: Plug Supplied on Indoor Unit only.

PRODUCT AND SERVICE

IMPORTANT PRODUCT AND SERVICES DETAILS

We want to provide the information you need to take advantage of the great products and services in this catalog. Please check our website or call our toll free number for more information.

■ **Changes:**

- Price, products and offers in the catalog may change without notice.
- Turbo Air cannot be responsible for pricing or other errors and reserves the right to cancel orders arising from such errors.

■ **Prices:**

- Our catalog prices do not include taxes and other fees (applicable for U.S. only).

■ **Shipping and Handling Charges:**

- Turbo Air will **offer free shipping and handling** under the following conditions:
 - The amount of one order is more than U.S. \$8,000.(Please be noted that you will have to ship all your items to a single U.S. address to receive free shipping and handling charges.)

■ **Warranties:**

- 1 year parts and 1 year compressor warranty on condensing units and unit coolers. Labor not included. (4 year extended warranty available for compressor: total 5 years)
- 2 year parts and 2 year compressor and 1 year labor on packaged refrigeration units. (Smart 7) (3 year extended warranty available for compressor: total 5 years)

For more details, please refer to the "Warranty Statement" on our website - www.turboairinc.net

■ **Exchange and Returns:**

Under the following conditions, you can return the ordered products without any charge:

- Received wrong item(s) due to our errors.
- Delivery delayed more than 3 days from promised date.
- Signs of external damage on arrival

If any of our product(s) do not meet your expectations, you may return them within 7 days after receiving the return confirmation from Turbo Air. The returned product(s) must be insured and prepaid. Please enclose your copy of the invoice or packing slip with the return. Please indicate whether you wish to exchange for another product(s), receive credit, or request a full refund of the purchase price. All products must be in new condition with original packaging and all included accessories. Please note there is a 20% restocking and repacking fee from the purchase price.

■ **Freight Damage:**

Inspection of the shipment is the consignee's obligation. Please make sure you are receiving the right merchandise in good condition upon delivery. When in doubt, write a note of "Damaged" on the delivery receipt before signing it. Notify the carrier and file a claim for any concealed damage. Please retain all cartons and product for inspection. Turbo Air is willing to assist and support you in filing your claim, but you must take the action of filing the claim.

WARRANTY STATEMENT

PACKAGE REFRIGERATION SYSTEMS (Smart 7)

Turbo Air Corp. warrants that package refrigeration products conform to the manufacturer's specifications and be free of defects in material and quality. Should any defects occur, Turbo Air Corp. will correct the defects subject to the following conditions.

PARTS: Two years from the date of installation or 30 months from the date of shipment, whichever occurs first. A proof of installation date is required if more than two years. If unit(s) is/are shipped directly to end user or installer, the warranty period is limited to two years.

COMPRESSOR: Two years from the date of installation or thirty months from the date of shipment, whichever comes first, Turbo Air, Corp. will supply a new compressor. During the two year warranty period, Turbo air, Corp. limits to one compressor ONLY. Replacement compressor comes with one year warranty covered by the supplier. If a second replacement compressor is needed within a year, the warranty must be claimed to the supplier directly. If unit(s) is/are shipped directly to end user or installer, the warranty period is limited to two years.

If the extended warranty is purchased, it is extended to three years from the end date of factory warranty. Turbo air, Corp. supplies ONLY one compressor during this period. Replacement compressor comes with one year warranty covered by the supplier as well. If a second replacement compressor is needed within a year, the warranty MUST be claimed to the supplier directly.

LABOR: For one year from date of sale or installation, Turbo Air Corp. can arrange a service technician to diagnose and resolve the issue of the unit.

PROOF OF PURCHASE: Copy of the proof of purchase is required to make this warranty valid. Alternatively, a valid manufacturer's serial number of the unit is required.

REMOTE REFRIGERATION SYSTEMS

Turbo Air Corp. warrants that remote refrigeration products conform to the manufacturer's specifications and be free of defects in material and workmanship. Should any defects occur, Turbo Air Corp. will correct the defects subject to the following conditions.

PARTS: If unit(s) is/are shipped directly to end user or installer, the warranty period is limited to one year.

COMPRESSOR: One year from the date of installation or twenty months from the date of shipment, whichever comes first, Turbo Air, Corp. will supply a new compressor. During the one year warranty period, Turbo air, Corp. limits to one compressor ONLY. Replacement compressor comes with one year warranty covered by the supplier as well. If a second replacement compressor is needed within a year, the warranty must be claimed to the supplier directly. If unit(s) is/are shipped directly to end user or installer, the warranty period is limited to one year.

If the extended warranty is purchased, it is extended to four years from the end date of factory warranty. Turbo air, Corp. supplies ONLY one compressor during this period. Replacement compressor comes with one year warranty covered by the supplier as well. If a second replacement compressor is needed within a year, the warranty MUST be claimed to the supplier directly.

PROOF OF PURCHASE: Copy of the proof of purchase is required to make this warranty valid, or a valid manufacturer's serial number of the unit is required.

THIS WARRANTY DOES NOT COVER LABOR OR:

- Shipping damage.
- System installation.
- Unpacking and/or removal of protective shipping material.
- Usage outside manufacturer's limitations as specified in the owner's manual.
- Service required as a result of improper installation, incorrect or insufficient AC supply voltage.
- Installation, set up, or adjustments of consumer controls.
- Any owner than the original owner.
- Damage from modification into other products.
- Any failure, loss, damage or personal injury due to accident, neglect, or abuse by the consumer, or to improper operation, maintenance or storage or to alteration or to failure to follow normal procedures as outlined in the instruction manual.
- Any unit purchased from an unauthorized dealer, any online retailer or not directly from Turbo Air.
- Transportation charges incurred in connection with warranty service.
- Indirect, consequential, or special damages, except as required by Federal or State laws.
- Repair or replacement of warranted part by other than qualified installer.

THE WARRANTY AND REMEDY STATED ABOVE ARE EXCLUSIVE AND IN LIEU OF ALL OTHER EXPRESS OR IMPLIED WARRANTIES INCLUDING, BUT NOT LIMITED TO, THE IMPLIED WARRANTIES OF MERCHANTABILITY OR FITNESS FOR A PARTICULAR PURPOSE. SOME LAWS DO NOT ALLOW EXCLUSION OF IMPLIED WARRANTY, THEREFORE THIS WARRANTY SHALL BE DEEMED MODIFIED TO BE CONSISTENT WITH SUCH LAWS.

Some states do not allow limitation on how long an implied warranty lasts; therefore these limitations or exclusions may not apply to you. This limited warranty gives you specific legal rights. You may also have other rights that may vary from state to state. This warranty applies to the United States (AK and HI excluded).

A chef in a white uniform and hat is pouring a dark liquid from a bottle into a metal bowl in a professional kitchen. The kitchen features stainless steel equipment, including a range hood with hanging pots and pans, a red oven, and a prep table with various condiments like a red pepper mill and yellow and red squeeze bottles.

Parts & Accessories

Common Parts & Accessories

Reach-in Parts & Accessories

Prep Table / Buffet Table Parts
& Accessories

Undercounter / Worktop Parts
& Accessories

Glass Door Merchandiser
Parts & Accessories

Ice Cream Dipping Cabinet
Parts & Accessories

Display Case Parts
& Accessories

Underbar Equipment Parts
& Accessories

Parts & Accessories

Common Parts & Accessories

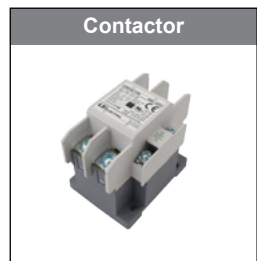
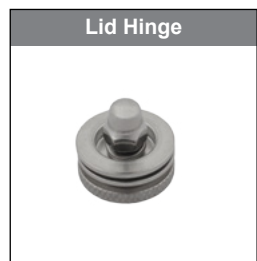
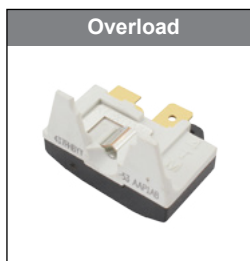
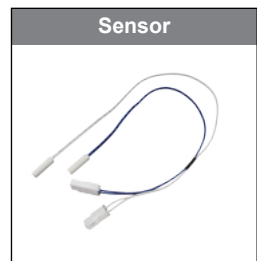
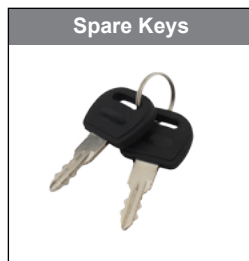
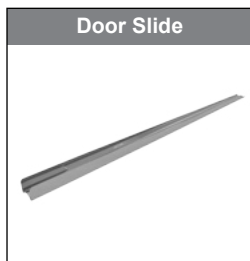
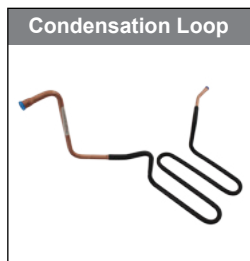
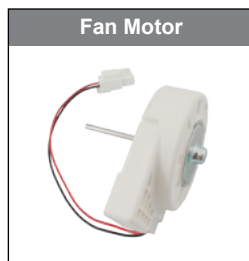
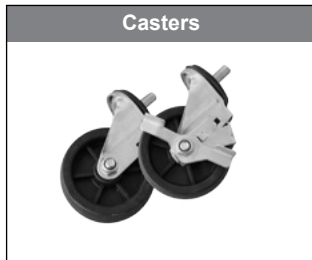
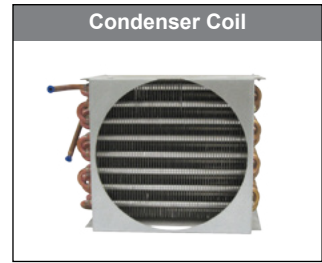
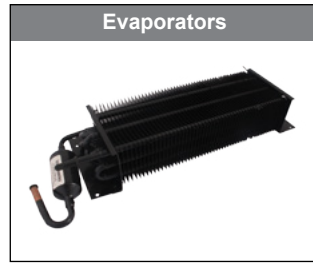
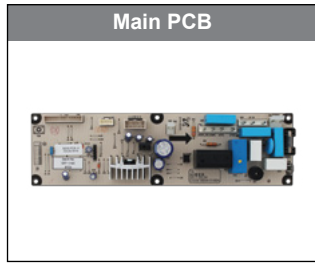

Parts & Accessories

Reach-In Parts & Accessories

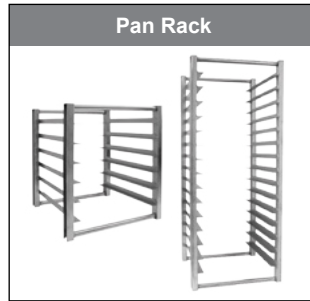
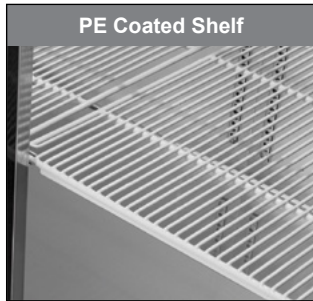

Prep Table / Buffet Table Parts & Accessories

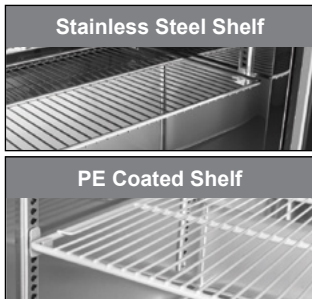

Parts & Accessories

Undercounter / Worktop Parts & Accessories



Glass Door Merchandiser Parts & Accessories

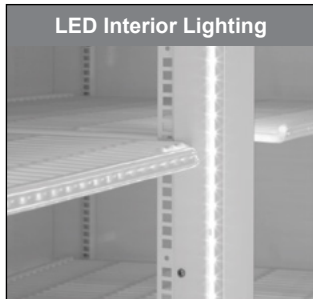
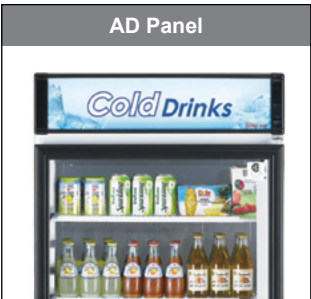
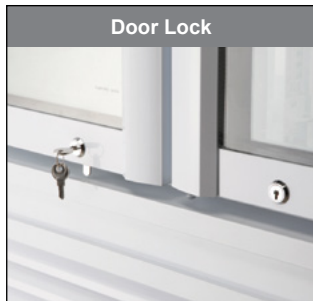

Ice Cream Dipping Cabinet Parts & Accessories

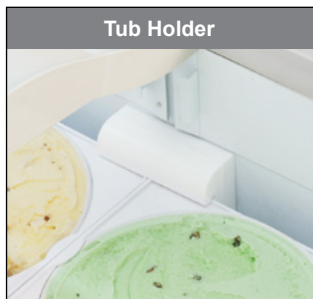
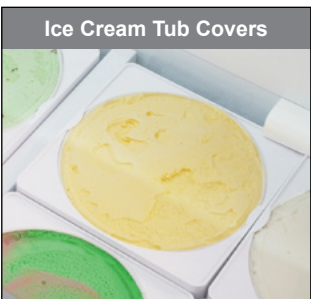
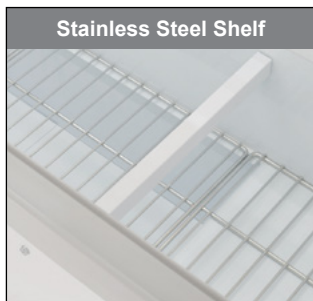

Parts & Accessories

Display Case Parts & Accessories

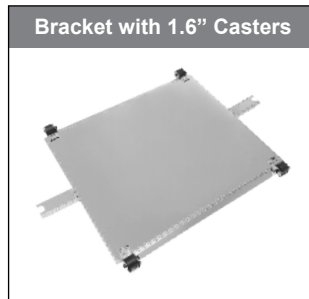
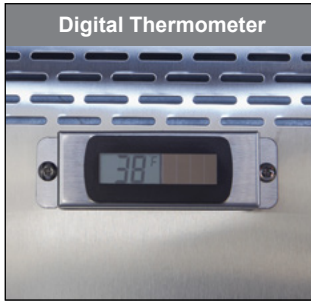

Underbar Equipment Parts & Accessories

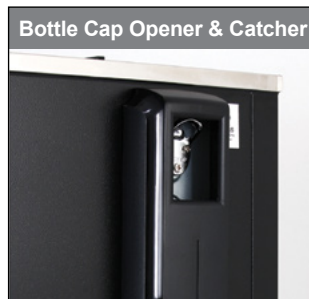

HASSLE-FREE WARRANTY

Exclusive to Turbo Air, our patented rotating condenser cleaning brush does not require basic preventative maintenance for warranty claims

5 Year Parts & Labor
7 Year Compressor Warranty

Self-Cleaning Condenser comes standard on all PRO Series.

All PRO Series are proudly built in Grand Prairie, Texas 



Patented, Maintenance free
Self-Cleaning Condenser
www.turboairinc.com

REFRIGERATOR MANUFACTURER
Turbo air



HASSLE-FREE WARRANTY

Exclusive to Turbo Air,
our patented rotating condenser cleaning brush
does not require basic preventative
maintenance for warranty claims

5 YEAR | **7** YEAR
PARTS & LABOR | COMPRESSOR
PRO/M3/Super Deluxe Series

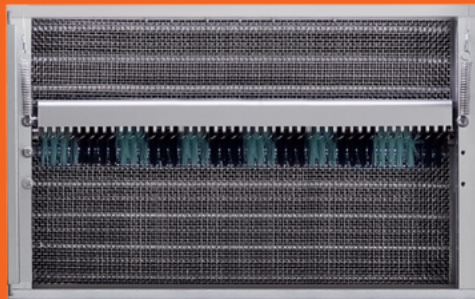

Patented, Maintenance free Self-Cleaning Condenser

The 'Self-Cleaning Condenser' cleans the condenser with a rotating brush that moves up and down 2-3 times a day, preventing any dust build-up and making it possible to always maintain the highest efficiency while saving additional energy.

www.turboairinc.com

REFRIGERATOR MANUFACTURER
Turbo air